

## All-metal angle valve with manual actuator

**Series 571**

**DN 10 – 40 mm (I. D.  $\frac{2}{5}$ " – 1½")**

This manual is valid for the following product ordering numbers:

**57120- . E02 - ....**

**57124- . E02 - ....**

**57132- . E02 - ....**

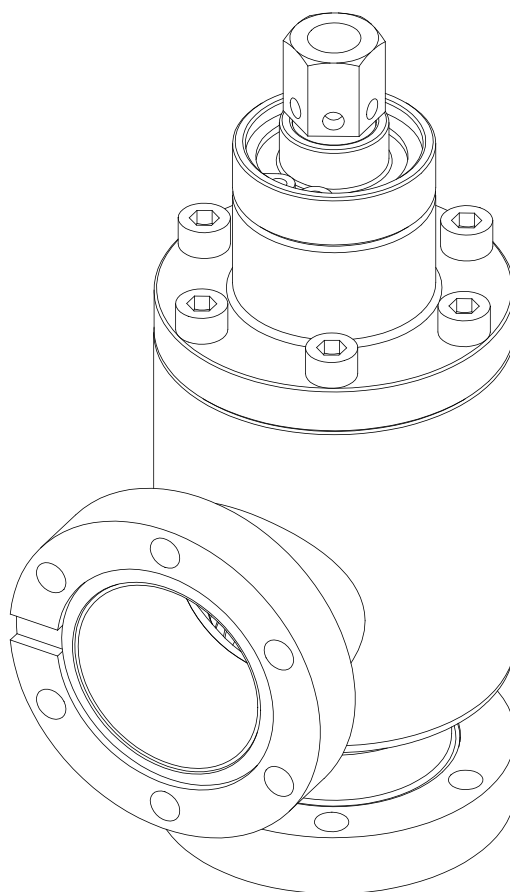

Sample picture

## Imprint

Manufacturer VAT Vakuumentile AG, CH-9469 Haag, Switzerland

Website: [www.vatvalve.com](http://www.vatvalve.com)  
Phone: +41 81 771 61 61  
Fax: +41 81 771 48 30  
Email: [CH@vatvalve.com](mailto:CH@vatvalve.com)

Publisher VAT Vakuumentile AG, CH-9469 Haag, Switzerland

Editor VAT Vakuumentile AG, CH-9469 Haag, Switzerland

Print VAT Vakuumentile AG, CH-9469 Haag, Switzerland

Copyright © VAT Vakuumentile AG 2013

No part of these instructions may be reproduced in any way (photocopies, microfilms or any other reproduction processes) nor may it be manipulated with electronic systems, duplicated or distributed without written permission from VAT. Offenders are liable to pay damages.

The original VAT firmware and updated state of the art versions of the VAT firmware are intended for use with VAT products. The VAT firmware contains a limited, time unlimited user license. The VAT firmware may not be used for purposes other than those intended nor is it permitted to make copies of the VAT firmware. In particular, it is strictly forbidden to give copies of the VAT firmware to other people.

The use of trade names, brand names, trademarks, etc. in these Instructions does not entitle third parties to consider these names to be unprotected and to use them freely. This is in accordance with the meaning of the laws and acts covering brand names and trademarks.

## Contents

<b>1</b>	<b>Description of product.....</b>	<b>4</b>
1.1	Identification of product.....	4
1.2	Use of product.....	4
1.3	Related documents .....	4
1.4	Important information .....	4
1.5	Technical data.....	4
<b>2</b>	<b>Safety .....</b>	<b>5</b>
2.1	Compulsory reading material.....	5
2.2	Danger levels .....	5
2.3	Personnel qualifications .....	6
2.4	Safety labels.....	6
<b>3</b>	<b>Design and Function.....</b>	<b>7</b>
3.1	Design .....	7
3.2	Function .....	8
<b>4</b>	<b>Installation .....</b>	<b>9</b>
4.1	Unpacking .....	9
4.2	Installation into the system.....	10
4.2.1	Preparation for installation.....	10
4.2.2	Mounting to the system .....	12
4.3	Electrical connection .....	12
<b>5</b>	<b>Operation .....</b>	<b>13</b>
5.1	Normal operation.....	13
5.2	Operation under increased temperature .....	13
5.3	Trouble shooting .....	14
<b>6</b>	<b>Maintenance .....</b>	<b>15</b>
6.1	Maintenance intervals .....	15
<b>7</b>	<b>Repairs.....</b>	<b>16</b>
7.1	Readjustment of sealing force .....	16
7.2	Replacement of dynamic seal VATRING.....	17
7.3	Adjustment of closing torque / assembly hexagon head .....	20
<b>8</b>	<b>Dismounting and Storage.....</b>	<b>22</b>
8.1	Dismounting .....	22
8.2	Storage.....	22
<b>9</b>	<b>Packaging and Transport .....</b>	<b>23</b>
9.1	Packaging .....	24
9.2	Transport.....	24
<b>10</b>	<b>Disposal .....</b>	<b>25</b>
<b>11</b>	<b>Spare parts .....</b>	<b>26</b>

# 1 Description of product

## 1.1 Identification of product

The fabrication number is lasered directly on the product.



XXXX-XXXX-XXXX/XXXX ←Fabrication number

Made in Switzerland

## 1.2 Use of product

Use product for clean and dry vacuum applications only. Other applications are only allowed with the written permission of VAT. Suitable for XHV applications.

## 1.3 Related documents

- Product data sheet
- Dimensional drawing

## 1.4 Important information



This symbol points to a very important statement that requires particular attention.

### Example:



VAT disclaims any liability for damages resulting from inappropriate packaging.

## 1.5 Technical data

See product data sheet and dimensional drawing.

Weights of standard valves:

DN 10: 0.5 kg  
DN 16: 0.8 kg  
DN 40: 2.3 kg

Weight of special valves, see product data sheet.

## 2 Safety

### 2.1 Compulsory reading material

Read this chapter prior to performing any work with or on the product. It contains important information that is significant for your own personal safety. This chapter must have been read and understood by all persons who perform any kind of work with or on the product during any stage of its serviceable life.

	NOTICE
	<p><b>Lack of knowledge</b> Failing to read this manual may result in property damage. Firstly, read manual.</p>





These Installation, Operating & Maintenance Instructions are an integral part of a comprehensive documentation belonging to a complete technical system. They must be stored together with the other documentation and accessible for anybody who is authorized to work with the system at any time.

### 2.2 Danger levels



	⚠ DANGER
	<p><b>High risk</b> Indicates a hazardous situation which, if not avoided, will result in death or serious injury.</p>

	⚠ WARNING
	<p><b>Medium risk</b> Indicates a hazardous situation which, if not avoided, could result in death or serious injury.</p>

	⚠ CAUTION
	<p><b>Low risk</b> Indicates a hazardous situation which, if not avoided, may result in minor or moderate injury.</p>

	NOTICE
	<p><b>Command</b> Indicates a hazardous situation which, if not avoided, may result in property damage.</p>

**2.3 Personnel qualifications**

	 <b>WARNING</b>
	<p><b>Unqualified personnel</b>                  Inappropriate handling may cause serious injury or property damage.                  Only qualified personnel are allowed to carry out the described work.</p>

**2.4 Safety labels**

Label	Part No.	Location on valve
	T-9001-155	On protective covers of flanges

Table 2-1

### 3 Design and Function

#### 3.1 Design

With manual actuator:  
Type 571 ... - . E02 - ....

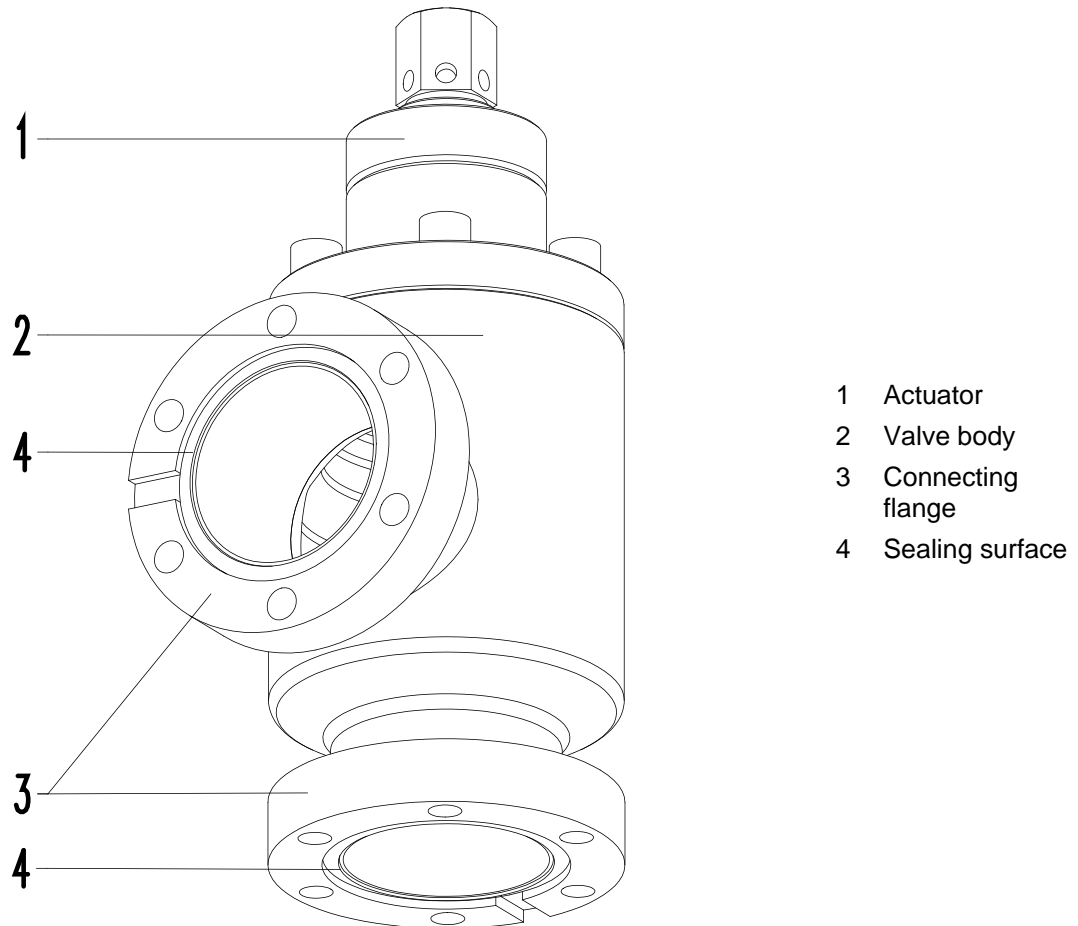

Figure 3-1

### 3.2 Function

Valve is closed and opened manually.

Closing: Turn hexagon head or inner square clockwise to its stop. For moving the plate only a small closing torque is required. Then a second step with a steadily increasing torque (sealing the valve) will follow until the stop is reached.

Opening: Turn hexagon head counter clockwise to its stop. The valve is completely open when the stop is reached.

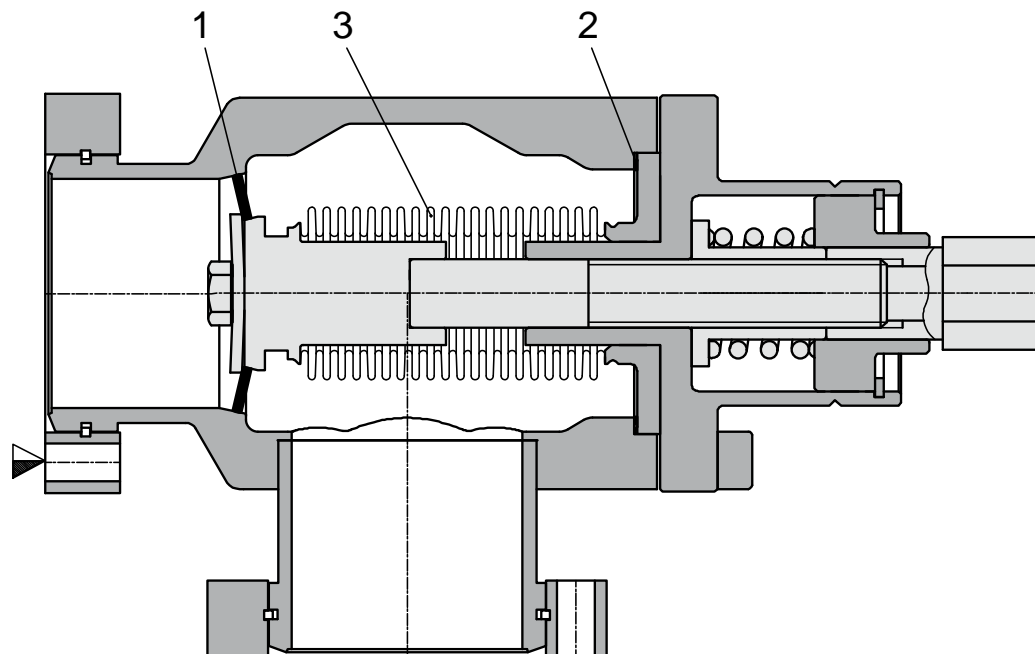



Figure 3-2

- 1 VATRING
- 2 Bonnet seal
- 3 Bellows
  
- ▼ Valve seat side



## 4 Installation

	<b>⚠ WARNING</b>
	<p><b>Unqualified personnel</b> Inappropriate handling may cause serious injury or property damage. Only qualified personnel are allowed to carry out the described work.</p>

### 4.1 Unpacking



- Make sure that the supplied products are in accordance with your order.
- Inspect the quality of the supplied products visually. If it does not meet your requirements, please contact VAT immediately.
- Store the original packaging material. It may be useful if products must be returned to VAT.





Don't open the plastic bag before mounting into the system.

	<b>NOTICE</b>
	<p><b>Sensitive product</b> Valve parts may get damaged.</p> <ul style="list-style-type: none"><li>– When lifting the valve, pay attention that the valve does not touch any solid objects.</li><li>– Lift valve carefully and put it down on a clean surface or mount it to a clean system.</li></ul>

Weight of standard valves; see chapter «1.5 Technical data».

## 4.2 Installation into the system

	NOTICE
	<p><b>Contamination</b></p> <p>Product may get contaminated. Always wear cleanroom gloves when handling the product.</p>

	NOTICE
	<p><b>Force effect from other components of the system</b></p> <p>Valve body may get deformed and/or malfunctions may occur.</p> <ul style="list-style-type: none"> <li>– Do not use valve to support other components.</li> <li>– Make sure that forces from other components do not impair the valve; use bellows sections, for instance.</li> </ul>

### 4.2.1 Preparation for installation

	⚠ WARNING
	<p><b>Danger of injury in case of insufficient skills</b></p> <p>Inappropriate handling may cause serious injury or property damage. Make sure that the valve does not topple or fall down while removing the protective covers from the flanges.</p>

	NOTICE
	<p><b>Sensitive product</b></p> <p>Valve parts may get damaged. When removing the protective covers from the flanges, be careful to avoid damage to the valve.</p>

1. Remove plastic bag.
2. Remove protective covers (1); see «Figure 4-1».

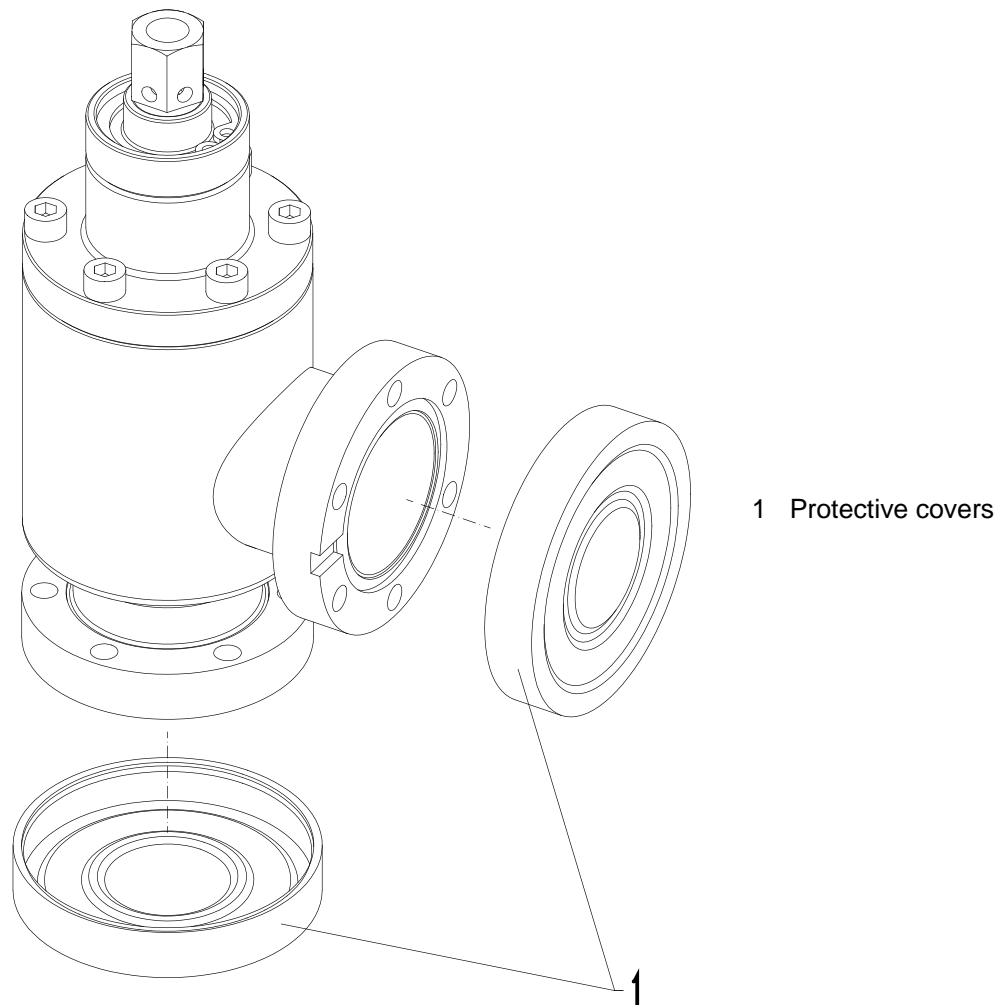

Figure 4-1



Store protective covers. They may be useful when valve needs to be repacked.

3. Clean sealing surfaces; see «Figure 3-1» on page 7, with cleanroom wiper soaked with pure alcohol (Isopropanol).
4. Clean sealing surface with clean, oil free compressed air.

**4.2.2 Mounting to the system**

1. Mount valve to your system by using appropriate flange screws (different quantity of screws required – depending on valve size).
2. Mount screws evenly in crosswise order until the seal touches the sealing surface.
3. Tighten all screws with the torques appropriate for the property classes of the screws.

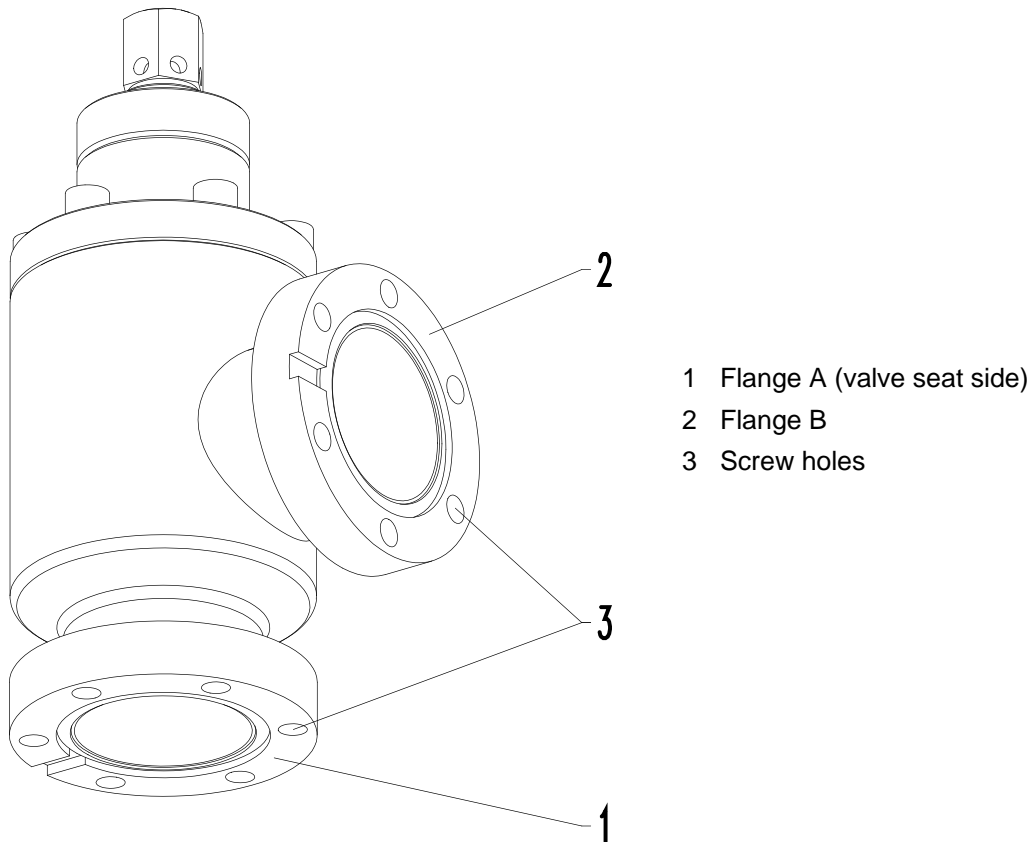



Figure 4-2

**4.3 Electrical connection**

	NOTICE
	<p><b>Wrong voltage</b>                  Electrical components may get damaged.                  Supply electrical components with the correct voltage.</p>

1. Connect position indicator (option) according to the product data sheet and dimensional drawing.

## 5 Operation

	 <b>WARNING</b>
	<p><b>Unqualified personnel</b> Inappropriate handling may cause serious injury or property damage. Only qualified personnel are allowed to carry out the described work.</p>

### 5.1 Normal operation

Valve is closed and opened manually.

**Closing:** Turn hexagon head or inner square clockwise to its stop. For moving the plate only a small closing torque is required. Then a second step with a steadily increasing torque (sealing the valve) will follow until the stop is reached.



The sealing force of the valve cannot be increased with a higher torque. The force to seal the valve is supplied by a spring, don't overtorque.

**Opening:** Turn hexagon head counter clockwise to its stop. The valve is completely open when the stop is reached.



If the mechanical stop in open position is reached, no additional torque shall be applied. To prevent any damage, the applied torque in fully open position must not exceed following torque:

DN 10: 2.5 Nm  
DN 16: 4 Nm  
DN 40: 12 Nm



For technical details, see product data sheet.

### 5.2 Operation under increased temperature

Maximum allowed temperature see product data sheet.

	<b>NOTICE</b>
	<p><b>Inconstant temperatures</b> Performance of the valve may deteriorate.</p> <ul style="list-style-type: none"> <li>– Actuate valve only after the bake-out temperature has been stable for two hours.</li> <li>– If valve must be actuated during bake-out, make sure that the heating or cooling rate does not exceed 10 °C per hour in the temperature range from 100 °C to 350 °C</li> <li>– Make sure that the temperature differences over the whole body do not exceed 60 °C.</li> </ul>

### 5.3 Trouble shooting

Failure	Check	Action	See
No or wrong position indicator signal	Position indicator connected correctly?	Check electrical power supply and wiring	Product data sheet
Leak at gate	Condition of gate seal	Please contact VAT	<a href="http://www.vatvalve.com">www.vatvalve.com</a>
	Condition of valve gate	Please contact VAT	<a href="http://www.vatvalve.com">www.vatvalve.com</a>
Leak at body	Condition of bonnet seal and sealing surface	Please contact VAT	<a href="http://www.vatvalve.com">www.vatvalve.com</a>
	Condition of bellows	Please contact VAT	<a href="http://www.vatvalve.com">www.vatvalve.com</a>

Table 5-1

If you need any further information, please contact one of our service centers. You will find the addresses on our website [www.vatvalve.com](http://www.vatvalve.com).

## 6 Maintenance



### 6.1 Maintenance intervals

Under clean operating conditions the valve does not require any maintenance during specified lifetime.



- Impacts from the process may require more frequent maintenance.
- When the valve has reached the specified lifetime; see product data sheet, we recommend to have it serviced by VAT. Please contact your nearest VAT service center to get recommendations and an offer. You will find the addresses on our website [www.vatvalve.com](http://www.vatvalve.com).

## 7 Repairs

	<p style="text-align: center;"><b>⚠ WARNING</b></p> <p><b>Unqualified personnel</b> Inappropriate handling may cause serious injury or property damage. Only qualified personnel are allowed to carry out the described work.</p>
	<p style="text-align: center;"><b>⚠ WARNING</b></p> <p><b>Danger of injury in case of insufficient skills</b> Inappropriate handling may cause serious injury or property damage. Make sure that the valve does not topple or fall down while removing the protective covers from the flanges.</p>
	<p style="text-align: center;"><b>NOTICE</b></p> <p><b>Contamination</b> Product may get contaminated. Always wear cleanroom gloves when handling the product.</p>

### 7.1 Readjustment of sealing force

1. Close valve.



Make sure that valve is closed to mechanical stop!

2. Remove slotted outer dowel pin (together with inner dowel pin) at the hexagon head.
3. Turn the hexagon head slightly counter clockwise back by one hole.
4. Press in slotted outer dowel pin (together with inner dowel pin) again.
5. Close valve.



## 7.2 Replacement of dynamic seal VATRING

In case of a seat seal leak caused by environmental influences and no visible damage of the sealing surface at the seat, the VATRING seal can be replaced.  
 VAT offers a range of components; see «Table 11-1» on page 26. The seal exchange is easily carried out by the user.

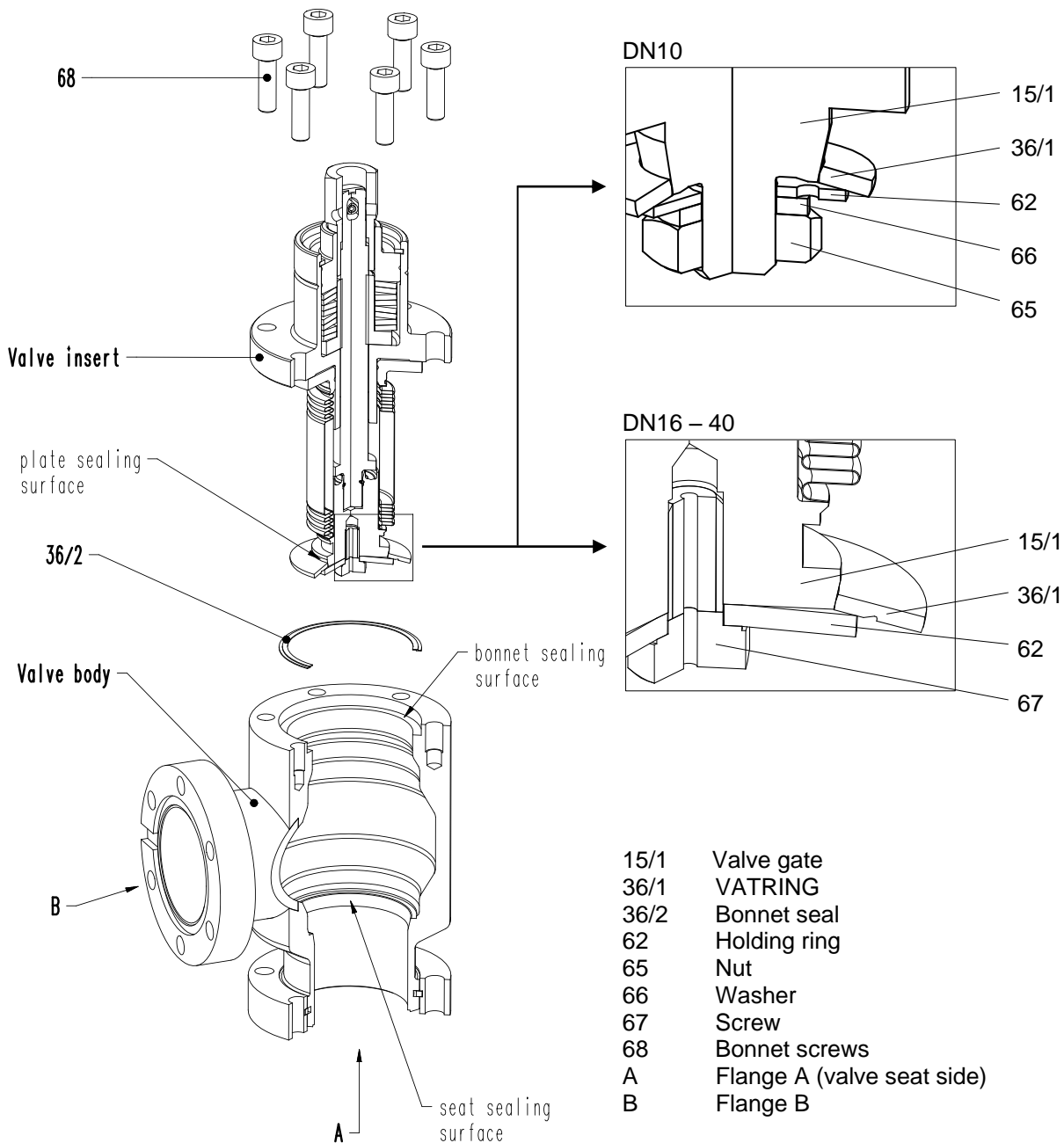



Figure 7-1

Required material: VATRING

Ordering information: See chapter «11 Spare parts» on page 26 and «Figure 7-1» on page 17.

<b>NOTICE</b>	
	<p><b>Inappropriate mounting position of valve</b></p> <p>Maintenance may be troublesome and parts may drop down.</p> <p>Ideally dismount valve from the system and put it on a clean workbench with the actuator upwards.</p>

**Procedure:**

The item numbers in brackets refer to; see «Figure 7-1» on page 17.

1. Open valve.
2. Remove the bonnet screws (68).
3. Pull valve insert carefully out of the valve body without touching the body wall. Touching the body wall may cause severe damage to delicate parts of the insert.
4. Remove bonnet seal (36/2).
5. Clean sealing surfaces of bonnet and seat of valve body with pure alcohol (Isopropanol).



When loosening and tightening the screw (67) or nut (65) protect the bellows against torsion with hole or wrench size; see «Figure 7-2» on page 19.

7. Remove the screw (67) or nut (65).
8. Remove the washer (66). Only valid for DN10.
9. Remove holding ring (62).
10. Remove VATRING (36/1).
11. Clean sealing surface of plate (21/1) with pure alcohol (Isopropanol), use a cleanroom wiper.



Make sure that the sealing surface is free of scratches.

12. Put new VATRING (36/1) on sealing surface of plate (15/1).



Make sure that the seal ring is installed in the correct direction.

13. Put holding ring (62) on plate (15/1).
14. Put washer (66) on plate (21/1). Only valid for DN10!
15. Insert screw (67) or nut (65) and tighten them slightly only.
16. Level out VATRING (36/1) and plate (15/1) along the whole circumference. Height difference shall not exceed 0.1 mm. Check height difference accurately at four spots (measured angle 90°) around the whole circumference.

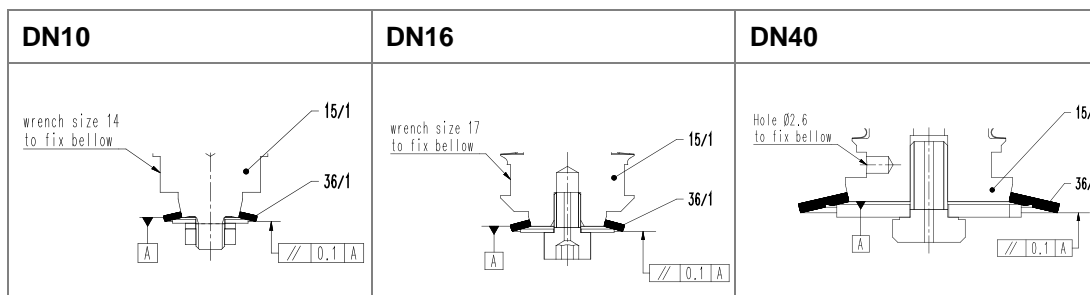

Figure 7-2

17. Clean sealing surfaces of bonnet and seat of valve body with pure alcohol (Isopropanol), use cleanroom wiper.
18. Protect bellows against torsion with hole or wrench size; see «Figure 7-2» and tighten screw (67) or nut (65) with the following torque:
  - DN 10: 2.5 Nm
  - DN 16: 2.5 Nm
  - DN 40: 7 Nm
19. Put bonnet seal (36/2) on sealing surface of valve body.
20. Move valve insert (in open position) carefully into body without touching the body wall. Touching the body wall may cause severe damage to delicate parts of the insert.
21. Insert all bonnet screws and tighten all screws gradually in crosswise order with the following torque:
  - DN 10: 7 Nm
  - DN 16: 7 Nm
  - DN 40: 7 Nm

Valve is ready for use.

### 7.3 Adjustment of closing torque / assembly hexagon head

#### New actuator components:

**Note:** This procedure works only for unused actuator components. As soon as the parts are baked the required closing torque will raise and the torque adjustment would end in a too small sealing force.

1. Place hexagon head (65); see «Figure 7-3» on the spindle (64) and fix it with following dowel pin (A) at the diameter:

DN 10 – 16: Ø3 mm at the diameter 13 mm  
 DN 40: Ø4 mm at the diameter 16 mm

2. Close the valve and do 10 cycles with the following torque:

DN 10: TBD  
 DN 16: 3.5 to 4 Nm  
 DN 40: 14 to 15 Nm

3. Go back to open position.

4. Close the valve with the following torque:

DN 10: TBD  
 DN 16: 3 – 3.5 Nm  
 DN 40: 10 Nm

5. Remove the dowel pin (A) with following diameter.

DN 10 – 16: Ø3 mm at the diameter 13 mm  
 DN 40: Ø4 mm at the diameter 16 mm

6. Turn by hand the hexagon head (65) clockwise to its mechanical stop; see «Figure 7-4».
7. Turn the hexagon head (1) slightly counter clockwise until the first hole (B) of hexagon head (65) reaches the slot of the spindle (64); see «Figure 7-5».

8. Put inner dowel pin (69) into outer dowel pin (70); see «Figure 7-6», so that the slits (C) of them are opposite to each other. Press them as one piece through the hole of the hexagon head (B) and the slot in the spindle (64).

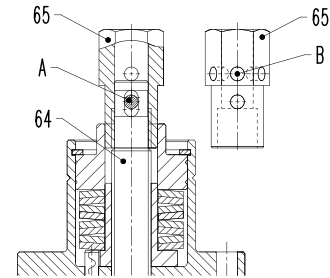

Figure 7-3

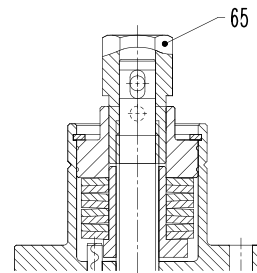

Figure 7-4

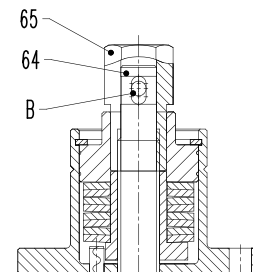

Figure 7-5

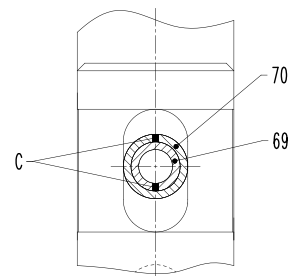

Figure 7-6

**Already used (and baked) actuator components:**

1. First measure required closing torque to reach the mechanical stop.
2. Perform steps of chapter «7.2 Replacement of dynamic seal VATRING».
3. Assemble valve again.
4. Release hexagonal head.
5. Place hexagon head (65); see «Figure 7-7», on the spindle (64) and fix it with following dowel pin (A) at the following diameter:

DN 10 – 16:     $\varnothing$ 3 mm at the diameter 13 mm  
 DN 40:            $\varnothing$ 4 mm at the diameter 16 mm

6. Close the valve with previous measured closing torque.
7. Remove the dowel pin (A) with following diameter:

DN 10 – 16:     $\varnothing$ 3 mm at the diameter 13 mm  
 DN 40:            $\varnothing$ 4 mm at the diameter 16 mm

8. Turn by hand the hexagon head (65) clockwise to its mechanical stop; see «Figure 7-8».
9. Turn the hexagon head (65) slightly counter clockwise until the first hole (B) of the hexagon head reaches the slot of the spindle (64); see «Figure 7-9».
10. Put inner dowel pin (69) into outer dowel pin (70); see «Figure 7-10», so that the slits (C) of them are opposite to each other. Press them as one piece through the hole of the hexagon head (B) and the slot in the spindle (64).

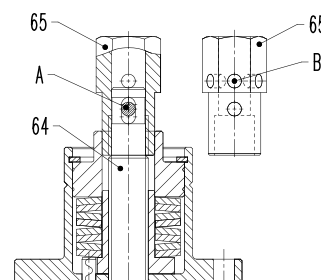

Figure 7-7

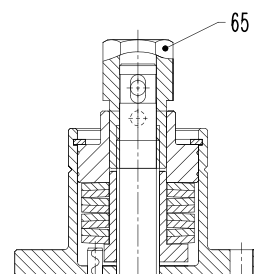

Figure 7-8

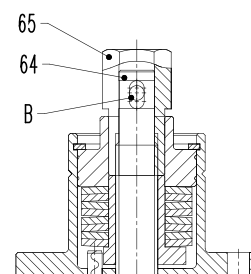

Figure 7-9

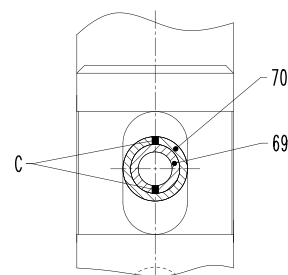

Figure 7-10

## 8 Dismounting and Storage

	⚠ <b>WARNING</b>
	<p><b>Unqualified personnel</b>                  Inappropriate handling may cause serious injury or property damage.                  Only qualified personnel are allowed to carry out the described work.</p>

	<b>NOTICE</b>
	<p><b>Contamination</b>                  Product may get contaminated.                  Always wear cleanroom gloves when handling the product.</p>

### 8.1 Dismounting

1. Dismount valve according chapter «4 Installation», however in reverse order.



Observe safety instruction of chapter «4 Installation».



### 8.2 Storage

	<b>NOTICE</b>
	<p><b>Wrong storage</b>                  Inappropriate temperatures and humidity may cause damage to the product.                  Valve must be stored at:</p> <ul style="list-style-type: none"> <li>– relative humidity between 10% and 70%</li> <li>– temperature between +10 °C and +50 °C</li> <li>– non-condensing environment</li> </ul>

	<b>NOTICE</b>
	<p><b>Inappropriate packaging</b>                  Product may get damaged if inappropriate packaging material is used.                  Always use the original packaging material and handle product with care.</p>

1. Clean / decontaminate valve.
2. Cover all valve openings with a protective foil.
3. Pack valve appropriately, by using the original packaging material.

## 9 Packaging and Transport

	<p style="text-align: center;"><b>⚠ WARNING</b></p> <p><b>Unqualified personnel</b> Inappropriate handling may cause serious injury or property damage. Only qualified personnel are allowed to carry out the described work.</p>
	<p style="text-align: center;"><b>⚠ WARNING</b></p> <p><b>Harmful substances</b> Risk of injury in case of contact with harmful substances. Remove harmful substances (e. g. toxic, caustic or microbiological ones) from valve before you return the valve to VAT.</p>
	<p style="text-align: center;"><b>NOTICE</b></p> <p><b>Inappropriate packaging</b> Product may get damaged if inappropriate packaging material is used. Always use the original packaging material and handle product with care.</p>



- When returning products to VAT, please fill out the VAT form «Declaration of Chemical Contamination» and send it to VAT in advance. The form can be downloaded from our website [www.vatvalve.com](http://www.vatvalve.com).
- If products are radioactively contaminated, the VAT form «Contamination and Radiation Report» must be filled out. Please contact VAT in advance.
- If products are sent to VAT in contaminated condition, VAT will carry out the decontamination procedure at the customer's expense.

## 9.1 Packaging

1. Cover all valve openings with protective covers; see chapter «4.2.1 Preparation for installation».
2. Pack valve appropriately, by using the original packaging material.



VAT disclaims any liability for damages resulting from inappropriate packaging.

## 9.2 Transport



### NOTICE

#### **Inappropriate packaging**



Product may get damaged if inappropriate packaging material is used.  
Always use the original packaging material and handle product with care.



VAT disclaims any liability for damages resulting from inappropriate packaging.



## 10 Disposal

	 <b>WARNING</b>
	<p><b>Harmful substances</b> Environmental pollution. Discard products and parts according to the local regulations.</p>

# 11 Spare parts

	NOTICE
	<p><b>Non-original spare parts</b></p> <p>Non-original spare parts may cause damage to the product. Use original spare parts from VAT only.</p>



- Please specify the fabrication number of the product when you place an order for spare parts; see chapter «1.1 Identification of product». This is to ensure that the appropriate spare parts are supplied.
- VAT makes a difference between spare parts that may be replaced by the customer and those that need to be replaced by the VAT service staff.
- «Table 11-1» only contains spare parts that may be replaced by the customer. If you need any other spare parts, please contact one of our service centers. You will find the addresses on our website [www.vatvalve.com](http://www.vatvalve.com).

Description	Item	DN	Part No.	Quantity per valve	Repair procedure see chapter
VATRING	36/1	10	45670-01	1	«7.2 Replacement of dynamic seal VATRING»
		16	38891-01	1	
		40	42372-01	1	
Bonnet seal	36/2	10	203120	1	
		16	209150	1	
		40	90367-01	1	
Bonnet screws	68	10	N-5019-788	4	
		16	N-5019-788	4	
		40	N-5019-790	6	
Inner dowel pin	69	10	N-6099-417	1	«7.3 Adjustment of closing torque / assembly hexagon head»
		16	N-6099-417	1	
		40	N-6097-432	1	
Outer dowel pin	70	10	N-6099-441	1	
		16	N-6099-441	1	
		40	N-6099-455	1	

Table 11-1