

This drawing is the property of VAT.

Revision

Customer number

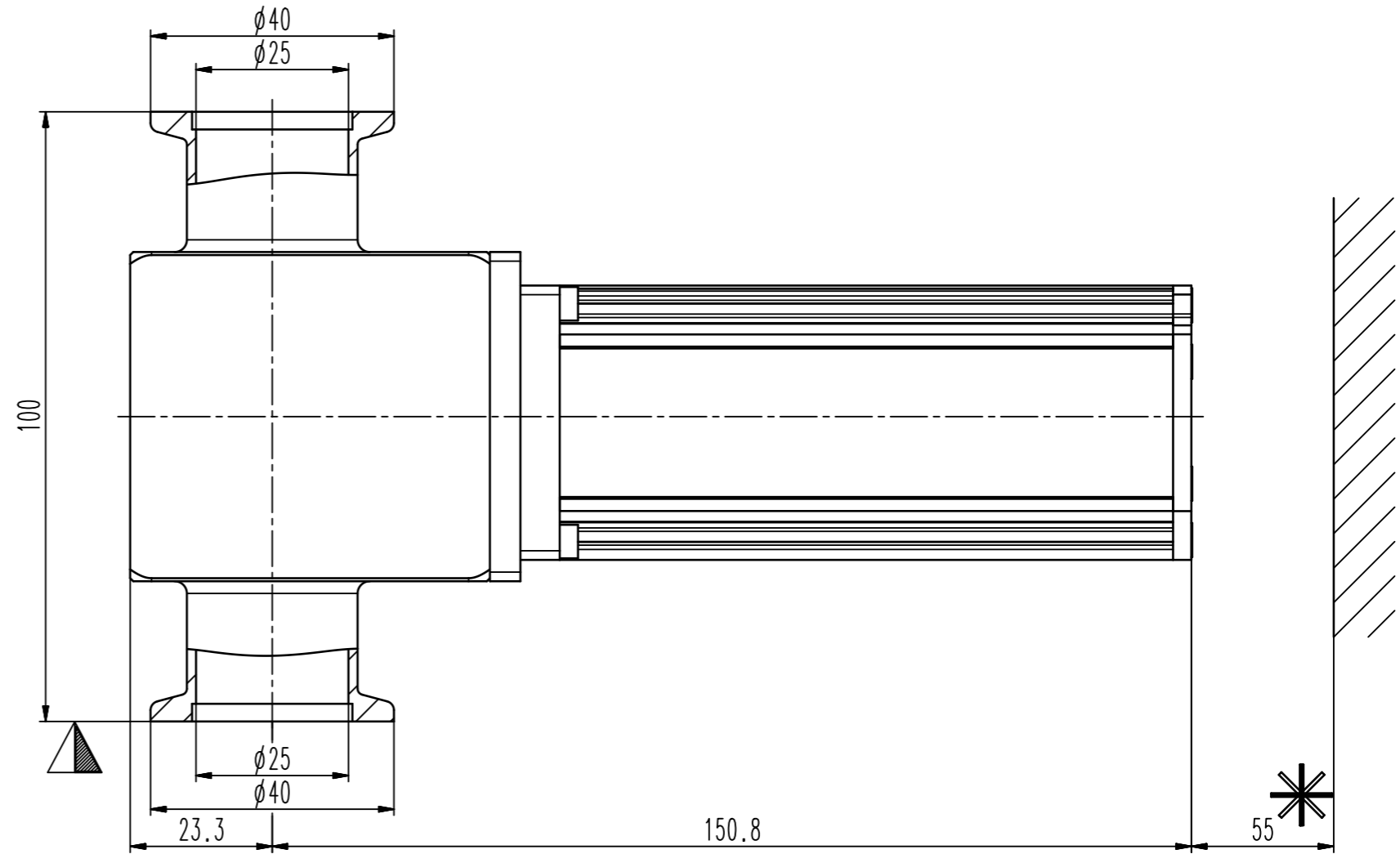
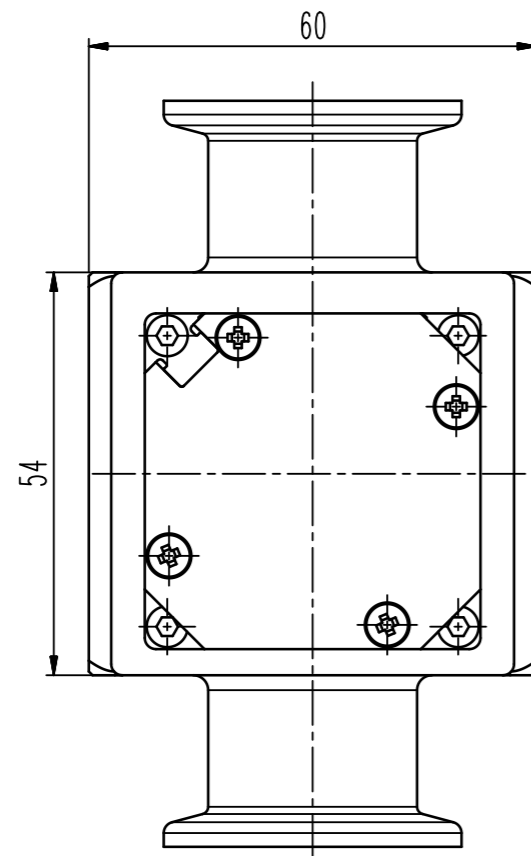

female M5
(10-32 UNF suitable)
4-8bar

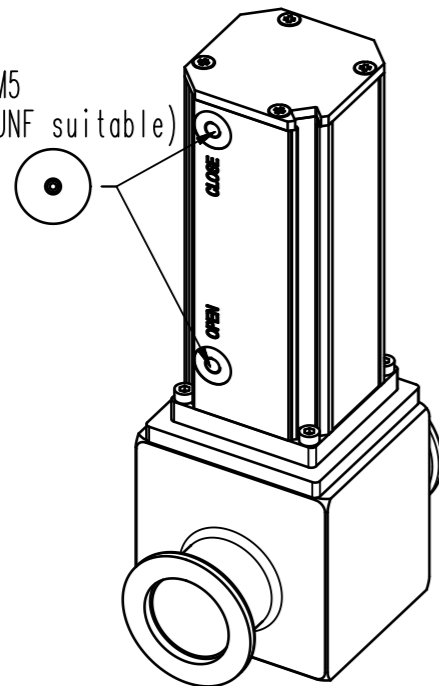

- ▼ Seat side
- ⊙ Comp. air connection
- ⊙ Electrical connection
- ⊙ Leak detection port
- ⊙ Mech. pos. indication
- ⊙ Position indicator
- ⊙ Required for dismantling
- ⊙ Emergency actuation
- ⊙ For attachment
- ⊙ Bake-out area
- ⊙ Differential pumping port

HV inline valve



VAT Vakuumventile AG
CH-9469 Haag, Switzerland
Tel ++41 81 7716161 Fax ++41 81 7714830

Rev.-Date: 15.04.11
Visa: GRX

Series	251	Ordering No.	25128-KA14-0001
Projection E	DN	Flange	
	25	ISO-KF	
Dimensional Drawing	487315	Rev.	