

Installation, Operating & Maintenance Instructions



Control angle valve with EtherCAT interface

Series 620 DN 40 - 50 mm (I.D. 1.5 - 2")

This manual is valid for the following product ordering numbers:

620GX -	(2 sensor inputs)
620AX -	(2 sensor inputs / $\pm 15V$ SPS)
620HX -	(2 sensor inputs / PFO)
620CX -	(2 sensor inputs / $\pm 15V$ SPS / PFO)

SPS = Sensor Power Supply PFO = Power Failure Option

Configured with firmware: **F01.0C.28.23** (or higher for use all described functions)

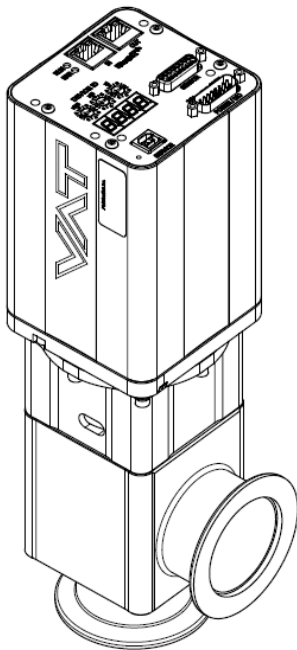

Sample picture

Imprint

Manufacturer VAT Vakuumentile AG, CH-9469 Haag, Switzerland

Website: www.vatvalve.com

Phone: +41 81 771 61 61

Fax: +41 81 771 48 30

Email: CH@vatvalve.com

Publisher VAT Vakuumentile AG, CH-9469 Haag, Switzerland

Editor VAT Vakuumentile AG, CH-9469 Haag, Switzerland

Print VAT Vakuumentile AG, CH-9469 Haag, Switzerland

Copyright © VAT Vakuumentile AG 2021

No part of these instructions may be reproduced in any way (photocopies, microfilms or any other reproduction processes) nor may it be manipulated with electronic systems, duplicated or distributed without written permission from VAT. Offenders are liable to pay damages.

The original VAT firmware and updated state of the art versions of the VAT firmware are intended for use with VAT products. The VAT firmware contains a limited, time unlimited user license. The VAT firmware may not be used for purposes other than those intended nor is it permitted to make copies of the VAT firmware. In particular, it is strictly forbidden to give copies of the VAT firmware to other people.

The use of trade names, brand names, trademarks, etc. in these Instructions does not entitle third parties to consider these names to be unprotected and to use them freely. This is in accordance with the meaning of the laws and acts covering brand names and trademarks.

Contents

1	Description of product.....	6
1.1	Identification of product	6
1.2	Use of product	6
1.3	Used abbreviations.....	6
1.4	Related documents.....	6
1.5	Important information.....	6
1.6	Technical data	7
1.6.1	Control and actuating unit	7
1.6.2	EtherCAT	8
1.6.3	Valve unit.....	9
2	Safety	11
2.1	Compulsory reading material.....	11
2.2	Danger levels	11
2.3	Personnel qualifications.....	12
2.4	Safety labels.....	12
3	Design and Function.....	13
3.1	Design	13
3.2	Pressure control system overview and function	13
3.2.1	Way of operation.....	14
3.2.2	Pressure control.....	14
3.2.3	Principle of a downstream pressure control system.....	14
4	Installation and Setup.....	15
4.1	Unpacking	15
4.2	Installation into the system	16
4.2.1	Installation space condition	17
4.2.2	Connection overview.....	17
4.2.3	Installation procedure.....	18
4.3	Tightening torque	19
4.3.1	Mounting with ISO-KF flanges	19
4.4	Electrical connection.....	19
4.4.1	Ground connection.....	20
4.4.2	Power and Sensor supply concepts.....	21
4.4.3	Power connector IO	25
4.5	Power Up, Homing	27
4.6	Power Down, Power Failure Option	28
4.7	Service port, CPA software	29
4.7.1	How to start.....	29
4.7.2	Update	30
4.8	Display information.....	31
4.8.1	Power up.....	31
4.8.2	Operation	32
4.8.3	Error	32
4.9	Pressure Sensor.....	33
4.9.1	Mechanical connection requirements.....	33
4.9.2	Configuration.....	34
4.9.3	Crossover (2 sensor operation mode).....	36
4.9.4	Zero Adjust.....	37
4.10	Pressure Control	38
4.10.1	Controller units.....	38
4.10.2	Automated Controller Selector	39
4.10.3	Control algorithm.....	41
4.10.4	Adaptive algorithm	43
4.10.5	PI algorithm.....	50
4.10.6	Soft pump algorithm.....	55
4.10.7	Pressure Ramp	58

4.10.8	Profile Ramp	60
4.10.9	Pressure Control Speed	62
4.11	Position Control	63
4.11.1	Position Control Speed	63
4.11.2	Position Ramp	63
4.12	EtherCAT interface	65
4.12.1	Connection	65
4.12.2	Device identification, Rotary switches	66
4.12.3	LEDs	67
4.12.4	Connection Loss Reaction	68
4.12.5	Position and pressure units	68
4.12.6	Communication failure	69
4.12.7	PDO Process data objects – cyclic communication	70
4.12.8	SDO Service data objects – acyclic communication	76
5	Operation	92
5.1	Remote and Local Operation	93
5.1.1	Access Mode	93
5.1.2	Remote operation	93
5.1.3	Local operation	93
5.2	Basic Functions	94
5.2.1	Close valve	94
5.2.2	Open valve	94
5.2.3	Position control	94
5.2.4	Pressure control	94
6	Trouble shooting	95
6.1	General	95
6.2	Errors	96
6.2.1	Controller Display	96
6.2.2	Error numbers	96
6.2.3	Error code	97
7	Maintenance	99
7.1	Drawing	100
7.2	Replacement of vacuum seals	100
7.2.1	Dismount actuator / controller	100
7.2.2	Replacement of plate seal	101
7.2.3	Mount actuator / controller	101
7.3	Replacement of Option board	103
8	Repairs	106
9	Dismounting and Storage	107
9.1	Dismounting	107
9.2	Storage	108
10	Packaging and Transport	109
10.1	Packaging	110
10.2	Transport	110
11	Disposal	111
12	Spare parts	112
12.1	Drawing	112
12.1.1	Valve unit	113
12.1.2	Control and actuating unit	113
12.1.3	Accessories	113

13	Appendix.....	114
-----------	----------------------	------------

1 Description of product

1.1 Identification of product

The fabrication number and order number are fixed on the product directly or by means of an identification plate.

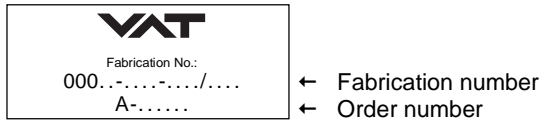

1.2 Use of product

This product is a Control angle valve with isolation functionality for downstream pressure control in vacuum systems.
 Use product for clean and dry vacuum applications only. Other applications are only allowed with the written permission of VAT.

1.3 Used abbreviations

Abbreviation	Description
CPA	Control Performance Analyzer
PFO	Power Failure Option
SFS	Sensor Full Scale
SPS	Sensor Power Supply
ADC	Analog-to-digital converter
IOMI	Installation, Operating & Maintenance Instructions

1.4 Related documents

- Product Data Sheet
- Dimensional Drawing
- IOMI Heating device (if valve with heater)

1.5 Important information



This symbol points to a very important statement that requires particular attention.

Example:



Refer to chapter: «Technical data» for detailed information.

1.6 Technical data

1.6.1 Control and actuating unit

Description		
Power supply input ¹⁾	connector	D-Sub, DA-15, male
	supply voltage	+24 VDC ($\pm 10\%$) @ 0.5 V pk-pk max.
Power consumption	(control / drive)	60 W (max.) ²⁾ with optional SPS +40 W with optional PFO +10 W ⁴⁾
Ambient	temperature	0 °C to +50 °C max. (<35 °C recommended)
	humidity	0 to 95% RH, non-condensing
Interface	remote	EtherCAT
	service port	USB-B (USB 2.0)
Digital inputs ³⁾	input 1	open valve (adjustable with CPA)
	input 2	close valve (adjustable with CPA)
	voltage control contact control	12 ... 24V / 4 ... 8 mA 24V / 8 mA
Digital outputs ³⁾	output 1	valve closed (adjustable with CPA)
	output 2	valve opened (adjustable with CPA)
	load	max. 70 V / 0.1 A
Sensor	connector	D-Sub, DA-15, female
	number of inputs	2
	signal voltage	0 ... 10V DC with linear pressure
	signal voltage range	-10 ... +10 V
	input resistance	100 k Ω
	ADC resolution	0.1 mV
	sampling rate	2 ms
	power supply (output) ²⁾	+24 VDC / 1.5 A max. or ± 15 VDC / 1.2 A max. (with SPS option)
Actuator		stepper motor, servo control
Pressure control accuracy		5 mV or 0.1% of setpoint, the higher value applies
Ingress Protection		IP 40

PFO ⁴⁾ battery pack [620 C / 620 H] Charging time Durability	1 minutes max. up to 10 years @ 25°C ambient; refer to «Durability of power fail battery» for details
--	---

- 1) Internal overcurrent protection by a PTC device.
- 2) Refer to chapter «Sensor supply concepts» for details. Complete power consumption of the valve depends on sensor supply concept and sensor power consumption
- 3) Refer to chapter «Schematics» for details.
- 4) PFO = Power Failure Option. Refer to chapter «Behavior in case of power failure» for details

1.6.2 EtherCAT

Description		
Connector		2 x RJ45, 8-pin (socket), IN and OUT
Communication	protocol	Protocol specialized for EtherCAT
	node address	Explicit device identification or station alias, set by switches
	physical layer	100BASE-Tx (IEEE 802.3)
Cable		shielded Ethernet CAT5e or higher

1.6.3 Valve unit

Description		
Pressure range at 20°C - Aluminum and stainless steel		(unheated on delivery) 1 x 10 ⁻⁸ mbar to 1.4 bar (abs)
Leak rate to outside (global) at 20°C - Aluminum and stainless steel		(unheated on delivery) 1 x 10 ⁻⁹ mbar ls ⁻¹
Leak rate seat at 20°C - Aluminum and Stainless steel		(unheated on delivery) 1 x 10 ⁻⁹ mbar ls ⁻¹
Note: This valve is normally equipped with a brake to assure the leak rate without electrical power supply. In case the brake is not present due to customization, the leak rate is assured during electrical power supply only.		
Cycles until first service		(under clean conditions)
• throttling (open – min. conductance – open)		2'000'000
• isolation (min. conductance – close – min. conductance)		1'000'000
Admissible operating temperature		10°C to 80°C
• Valve body / bellows / plate		
Mounting position		any (valve seat on chamber side is recommended)
Process side materials	body	Aluminum - EN AW-6082 (3.2315) or Stainless steel: AISI 316L (1.4404 or 1.4435)
	plate	Stainless steel: AISI 316L (1.4404 or 1.4435)
	bellows	Stainless steel: AISI 316L (14571)
	bellows end piece	Stainless steel: AISI 316L (1.4404 or 1.4435)
Seals	plate	FKM (e.g. Viton®)
	bonnet	FKM (e.g. Viton®)

DN (nominal I. D.)	[mm]	40	50
	[inch]	1½"	2"
Max. differential pressure on plate (close position) [mbar]		1000	1000
Max. differential pressure on plate	Opening direction [mbar]	1000	1000
	Closing direction [mbar]	1400	1400
Actuating time (typical)	Throttling (pressure / position control) 0% -> 100% 100% -> 0%	1.7 s	1.9 s
	Close 0% -> isolated 0% -> close signal 100% -> isolated 100% -> close signal	0.6 s 1.1 s 1.25 s 1.75 s	0.6 s 1.1 s 1.35 s 1.85 s
	Open Isolated -> 0% 0% -> 100%	0.25 s 0.65 s	0.25 s 0.75 s
Stroke [mm]		12.5	14.1
Position resolution		125'000	141'400
Min. controllable conductance	N ₂ molecular flow [ls ⁻¹]	0.05	0.1
Max. conductance	N ₂ molecular flow [ls ⁻¹]	45	80
Weight (approx.) Aluminum valve	Aluminum [kg]	2.3	2.6
	Aluminum [lbs]	5.1	5.8
Weight (approx.) Stainless steel valve	Steel [kg]	3.2	3.5
	Steel [lbs]	7.1	7.7

2 Safety

2.1 Compulsory reading material

Read this chapter prior to performing any work with or on the product. It contains important information that is significant for your own personal safety. This chapter must have been read and understood by all persons who perform any kind of work with or on the product during any stage of its serviceable life.

	NOTICE
	<p>Lack of knowledge</p> <p>Failing to read this manual may result in property damage. Firstly, read manual.</p>





These Installation, Operating & Maintenance Instructions are an integral part of a comprehensive documentation belonging to a complete technical system. They must be stored together with the other documentation and accessible for anybody who is authorized to work with the system at any time.

2.2 Danger levels



	⚠ DANGER
	<p>High risk</p> <p>Indicates a hazardous situation which, if not avoided, will result in death or serious injury.</p>

	⚠ WARNING
	<p>Medium risk</p> <p>Indicates a hazardous situation which, if not avoided, could result in death or serious injury.</p>

	⚠ CAUTION
	<p>Low risk</p> <p>Indicates a hazardous situation which, if not avoided, may result in minor or moderate injury.</p>

	NOTICE
	<p>Command</p> <p>Indicates a hazardous situation which, if not avoided, may result in property damage.</p>

2.3 Personnel qualifications

	 WARNING
	<p>Unqualified personnel Inappropriate handling may cause serious injury or property damage. Only qualified personnel are allowed to carry out the described work.</p>

2.4 Safety labels

Label	Part No.	Location on valve
	T-9001-155	On protective foil covering of valve opening

3 Design and Function

3.1 Design

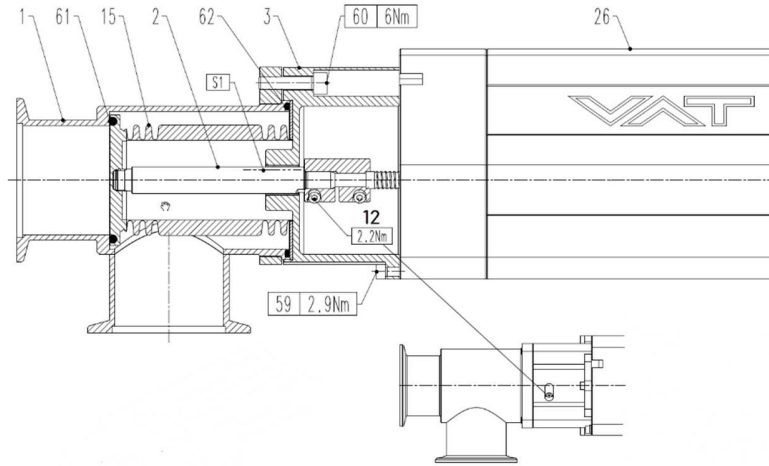

- 1 Body
- 2 Rod
- 3 Flange
- 12 Coupling screw
- 15 Bellows Feedthrough
- 26 Actuator / Controller
- 59 Actuator screw
- 60 Bonnet screw
- 61 Plate seal
- 62 Bonnet seal

3.2 Pressure control system overview and function

Vacuum pressures are always absolute pressures unless explicitly specified as pressure differences.

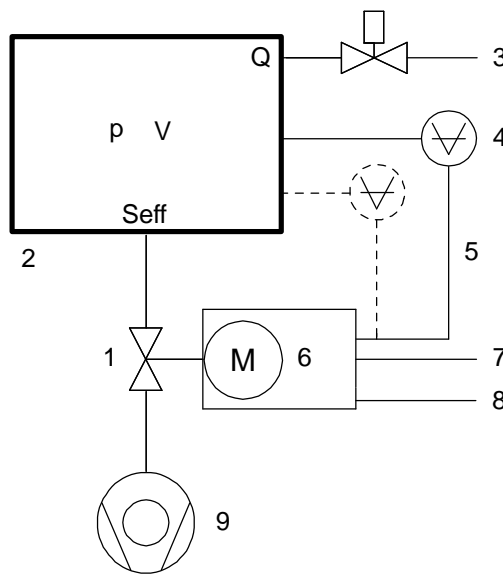

- 1 Valve
- 2 Process chamber
- 3 Gas inlet
- 4 Pressure sensor(s)
- 5 Sensor cable
- 6 Controller and actuator
- 7 Cable to remote control unit
- 8 Cable to power supply
- 9 HV Pump

$S_{eff} = Q / p$
 S_{eff} effective pump speed ($l \cdot s^{-1}$)
 Q Gas flow (mbar)
 p Pressure (mbar)

or units used in USA
 $S_{eff} = 12.7 \cdot Q / p$
 S_{eff} effective pump speed ($l \cdot s^{-1}$)
 Q Gas flow (sccm)
 p Pressure (mTorr)

Example: **Downstream control**

3.2.1 Way of operation

The controller compares the actual pressure in the process chamber given by the pressure sensor with the preset pressure. The controller uses the difference between actual and set pressure to calculate the correct position of the control valve. The controller drives the control valve into the correct position and the actual pressure again equals the set pressure. This control operation is performed continuously. Pressure changes in the process chamber due to leaks, desorption, and gas flow, reaction products, variations in pumping speed etc. are always corrected at once.

3.2.2 Pressure control

In a vacuum system which is pumped and into which gas is admitted at the same time, the pressure can be controlled in two ways:

1. Downstream control (standard):
The pressure is controlled by changing the conductance of a control valve between pump and process chamber. This changes the effective pumping speed at the process chamber. Pressure and gas flow can be independently controlled over a wide range.
2. Upstream control:
The pressure is controlled by changing the gas flow into the process chamber, while the pumping speed remains constant.

3.2.3 Principle of a downstream pressure control system

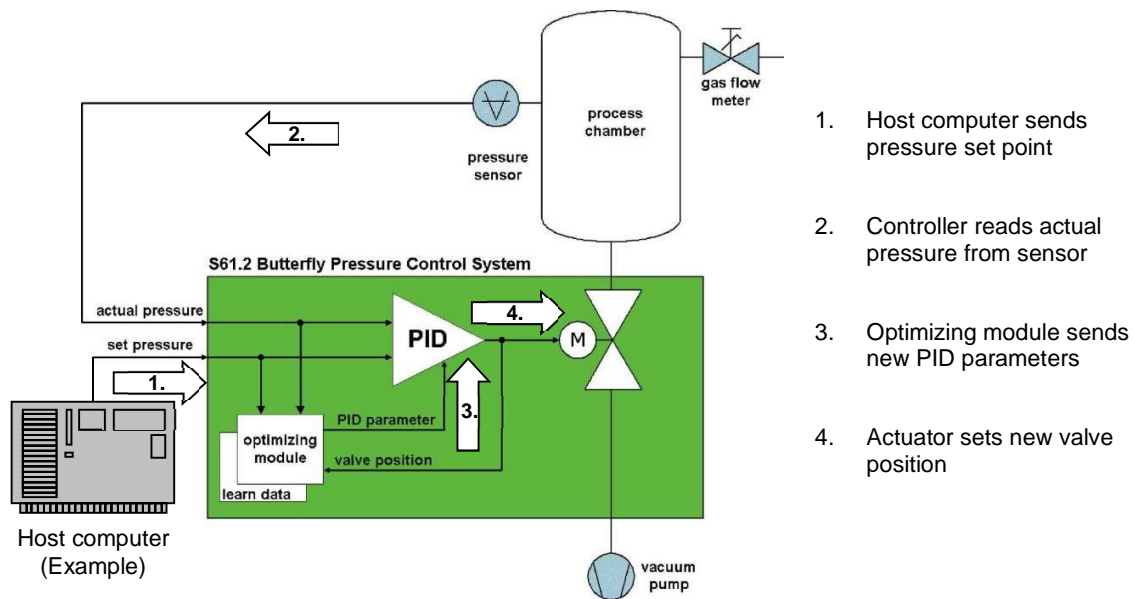

4 Installation and Setup

	⚠ WARNING
	Unqualified personnel Inappropriate handling may cause serious injury or property damage. Only qualified personnel are allowed to carry out the described work.

4.1 Unpacking

	NOTICE
	Physical overstraining at controller Inappropriate handling with the valve may cause in damage of controller. Do not place the valve on the controller.

	NOTICE
	Physical overstraining at pedestal Inappropriate handling with the valve may cause in damage of pedestal. Lift valve at valve body out of transport case.



- Make sure that the supplied products are in accordance with your order.
- Inspect the quality of the supplied products visually. If it does not meet your requirements, please contact VAT immediately.
- Store the original packaging material. It may be useful if products must be returned to VAT.

1. Open the transport case and remove inside packing material as far as necessary.
2. Lift the valve carefully and place it on a clean place.



Do not remove protective foils from valve opening

4.2 Installation into the system

	⚠ WARNING
	<p>Valve opening</p> <p>Risk of serious injury.</p> <p>Human body parts must be kept out of the valve opening and away from moving parts. Do not connect the controller to power before the valve is installed complete into the system.</p>

	NOTICE
	<p>Sealing surfaces</p> <p>Sealing surfaces of valve and vacuum system could be damage in case of incorrect handling.</p> <p>Only qualified personal are allowed to install the valve into the vacuum system.</p>

	NOTICE
	<p>Wrong connection</p> <p>Wrong connection may result in damage of controller or power supply.</p> <p>Connect all cables exactly as shown in the following descriptions and schematics.</p>

	NOTICE
	<p>Burned connector pins (spark)</p> <p>Connector pins or electronic parts could damage, if plugged and unplugged under power.</p> <p>Do not plug or unplug connectors under power.</p>

	NOTICE
	<p>Contamination</p> <p>Gate and other parts of the valve must be protected from contamination.</p> <p>Always wear clean room gloves when handling the valve.</p>



Mount valve to a clean system only.

4.2.1 Installation space condition



Install the valve with integrated controller with space for dismantling and air circulation as shown in figure below.

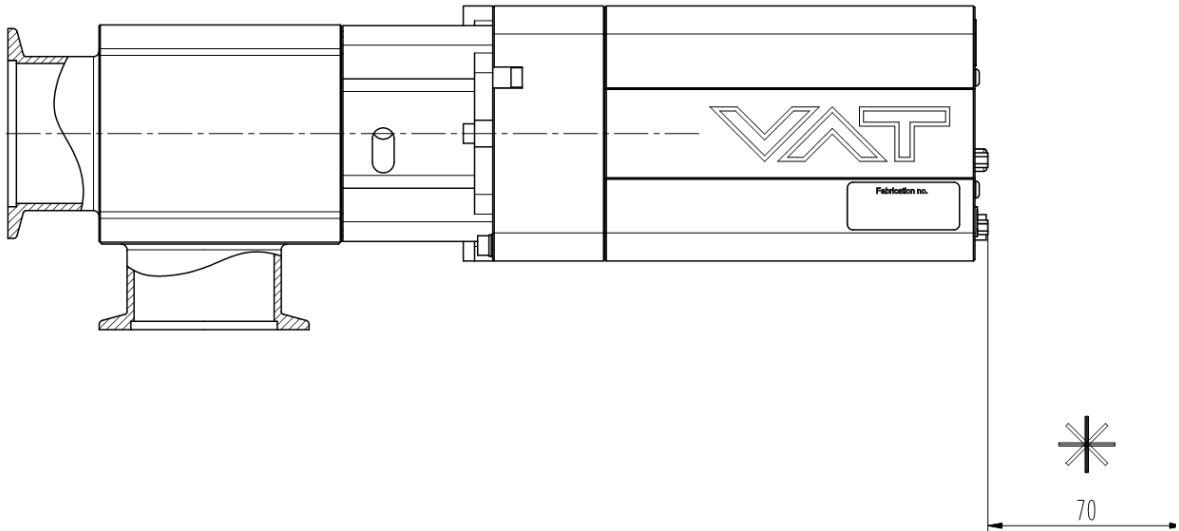

Sample picture

4.2.2 Connection overview

System: Downstream

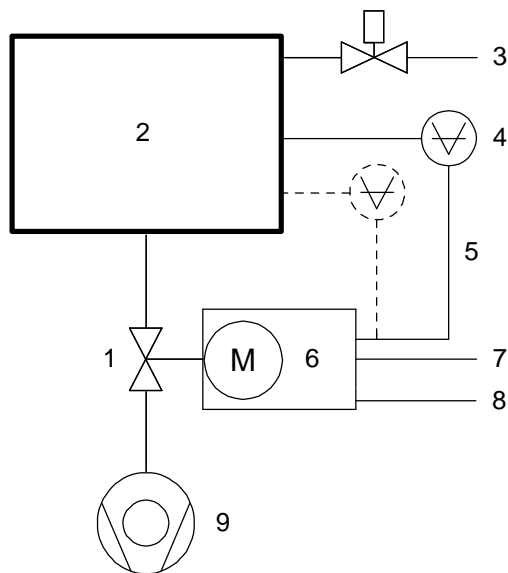

- 1 Valve
- 2 Process chamber
- 3 Gas inlet
- 4 Pressure sensor(s)
- 5 Sensor cable(s)
- 6 Controller and actuator
- 7 Cable to remote control unit
- 8 Cable to power supply and remote control unit
- 9 Pump

Controller:

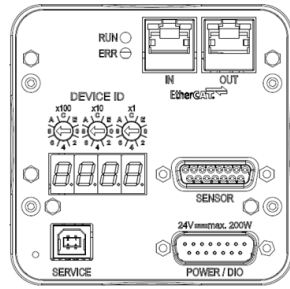

Sample picture

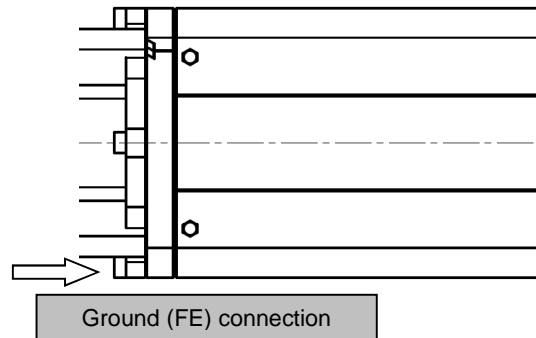

4.2.3 Installation procedure

All numbers in brackets refer to chapter: «Connection overview».

1. Remove protective covers from body flanges.
2. Install [1] valve into the vacuum system. Valve seat side shall face process chamber.
 - The valve seat side is indicated by the symbol "Δ" on the dimensional drawing.
 - Do not tighten the KF flange screws stronger than indicated under chapter «Tightening torque».
 - Do not admit higher forces to the valve than indicated under chapter «Admissible forces».
 - Make sure that enough space is kept free to do preventive maintenance work. The required space is indicated on the dimensional drawing.
3. Install the ground connection cable at controller. Refer to chapter «Electrical connection».
4. Install sensor(s) [4] according to the recommendations of the sensor manufacturer and directives given under chapter «Requirements to sensor connection».
5. Connect sensor cable [5] to sensor(s) and then to valve (connector: SENSOR). Refer to chapter «Electrical connection» for correct wiring.
6. Connect valve with cable [7] to remote control unit (connector: EtherCAT). Refer to «EtherCAT interface» for correct wiring.
7. Connect power supply cable [8] to valve (connector: POWER / DIO). Refer to chapter «Electrical connection» for correct wiring.
Optionally digital I/O may can be connected. Refer to chapter «Power Connector IO» for correct wiring.



To provide power to the valve motor pins 4 and 11 must be bridged, otherwise motor interlock is active and the valve enters the safety mode and is not operative. Refer also to chapter «Safety mode».

8. Perform chapter «Setup procedure» to prepare valve for operation.





Without performing the setup procedure the valve will not be able to do pressure Control.

4.3 Tightening torque

4.3.1 Mounting with ISO-KF flanges

Tightening torques for ISO-KF flange connections depend on the type of seal which is used. Follow recommendations of seal manufacturer.

4.4 Electrical connection

	<p style="text-align: right;">NOTICE</p> <p>Wrong connection Wrong connection may result in damage of controller or power supply. Connect all cables exactly as shown in the following descriptions and schematics.</p>
	<p style="text-align: right;">NOTICE</p> <p>Burned connector pins (spark) Connector pins or electronic parts could damage, if plugged and unplugged under power. Do not plug or unplug connectors under power.</p>

4.4.1 Ground connection

Recommendation for ground connection between controller and system chassis with cable (AWG12 / 4 mm²) or with ground strap.

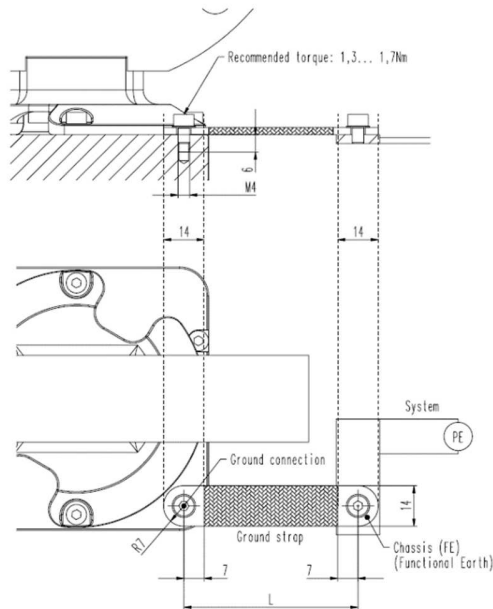

- Connection plates of ground strap must be total plane for a good electrical contact!
- The connection point at chassis (FE) must be blank metal (not coated). It is also possible to connect the ground strap at system chamber if it is well connected to PE.
- Avoid low chassis cross section to the system PE connection. (min. same cross section as ground strap)

4.4.2 Power and Sensor supply concepts

This valve offers different concepts to supply the sensor(s) with power. This depends on the sensor type and valve version that is used.

Concepts:

- **24 VDC sensors**

External +24 VDC supplied to POWER connector is feedthrough to SENSOR connector.
Refer to chapter «Power and sensor connection (+24 VDC sensors)»

- **±15 VDC sensors**

- External ±15 VDC supplied to POWER connector is feedthrough to SENSOR connector.
Refer to chapter «Power and sensor connection (±15 VDC sensors)»
- External +24 VDC supplied to POWER connector is converted into ±15 VDC by the valve internal SPS and supplied to SENSOR connector.
Refer to chapter «Power and sensor connection (±15 VDC sensors) with optional SPS module»



This concept is only possible when Sensor Power Supply (SPS) option is installed.

Valve versions:

- 620 **G** and 620 **H** SPS module not included
- 620 **A** and 620 **C** SPS module included



The SPS module can be retrofitted.
Refer to chapter «Retrofit / replacement procedure» for instruction.

4.4.2.2 Power and sensor connection (+24 VDC sensors)

[620 G / 620 H versions recommended]

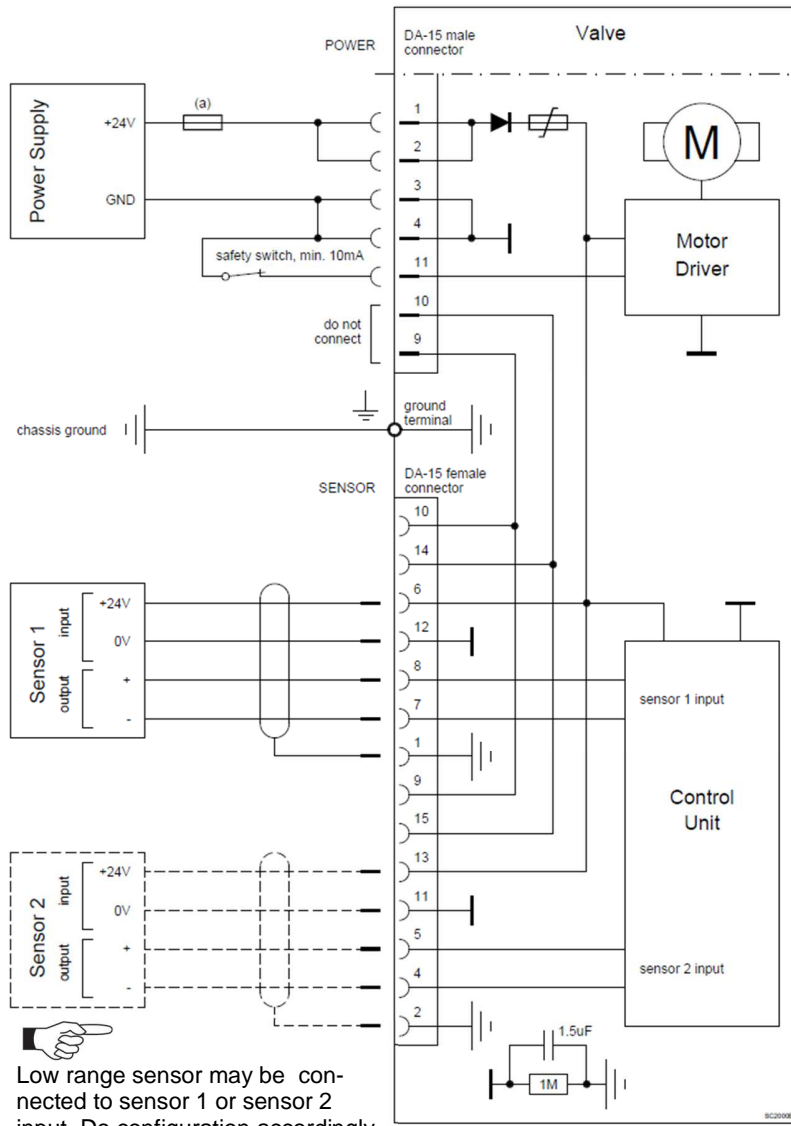

Pins 4 and 11 must be bridged for operation. An optional switch would allow for motor interlock to prevent valve from moving.

Low range sensor may be connected to sensor 1 or sensor 2 input. Do configuration accordingly

- **VAT fuse recommendation: (a) 3 AF**
- Use shielded sensor cable(s). Keep cable as short as possible, but locate it away from noise sources.
- Connector: Use only screws with 4–40 UNC thread for fastening the connectors!

4.4.2.3 Power and sensor connection (± 15 VDC sensors)

[620 G / 620 H versions recommended]

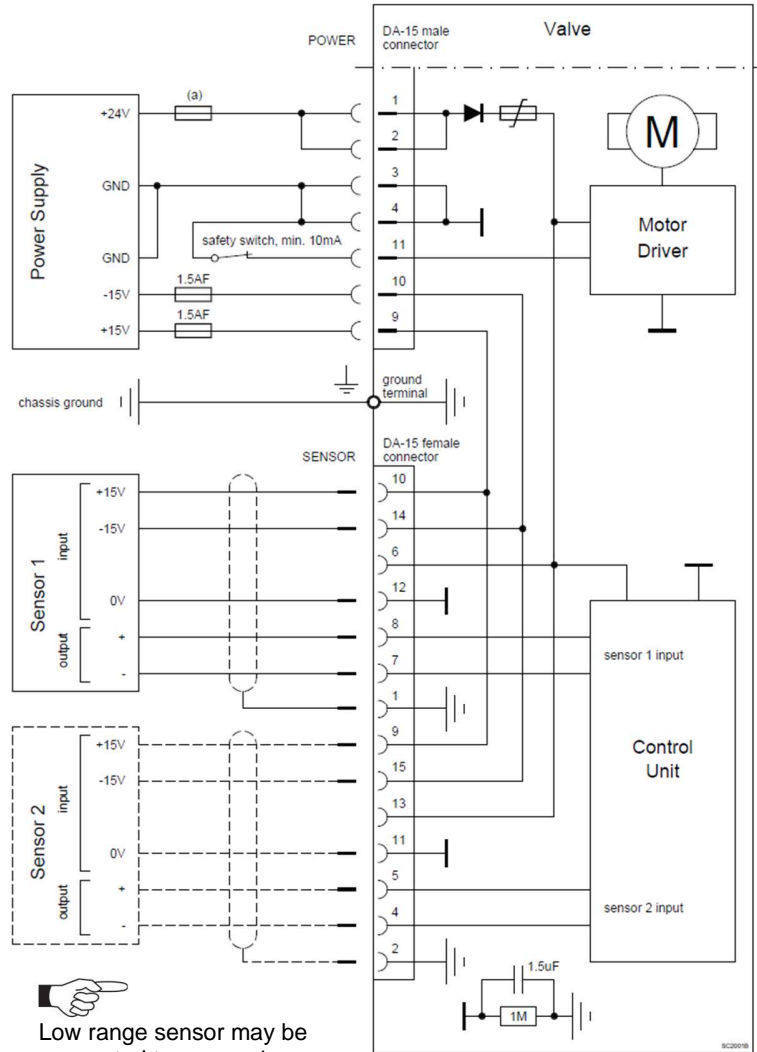

Pins 4 and 11 must be bridged for operation. An optional switch would allow for motor interlock to prevent valve from moving.

Low range sensor may be connected to sensor 1 or sensor 2 input. Do configuration accordingly.

- **VAT fuse recommendation: (a) 3 AF**
- Use shielded sensor cable(s). Keep cable as short as possible, but locate it away from noise sources.
- Connector: Use only screws with 4–40 UNC thread for fastening the connectors!

4.4.2.4 Power and sensor connection (± 15 VDC sensors) with optional SPS module

[620 A / 620 C versions only]

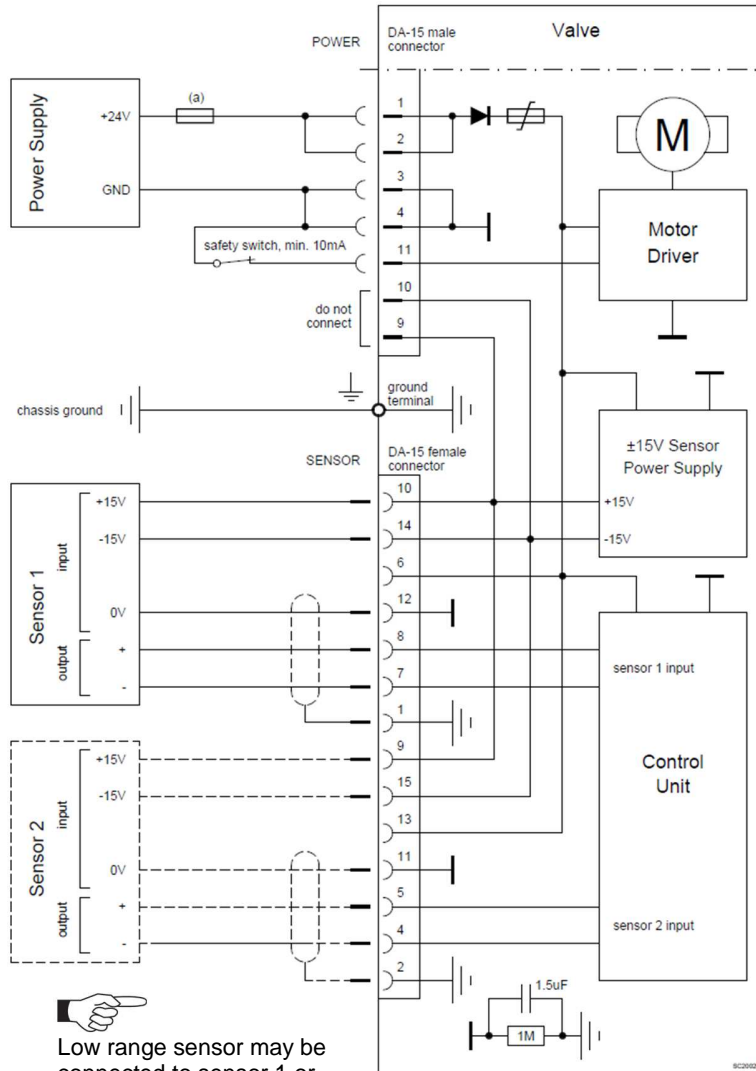

Pins 4 and 11 must be bridged for operation. An optional switch would allow for motor interlock to prevent valve from moving.

Low range sensor may be connected to sensor 1 or sensor 2 input. Do configuration accordingly.

- VAT fuse recommendation: (a) 3 AF
- Use shielded sensor cable(s). Keep cable as short as possible, but locate it away from noise sources.
- Connector: Use only screws with 4–40 UNC thread for fastening the connectors!

4.4.3 Power connector IO



Do not connect other pins than indicated in the schematics!
Use only screws with 4-40UNC thread for fastening the DA-15 connector!

4.4.3.1 Digital Input

Connection

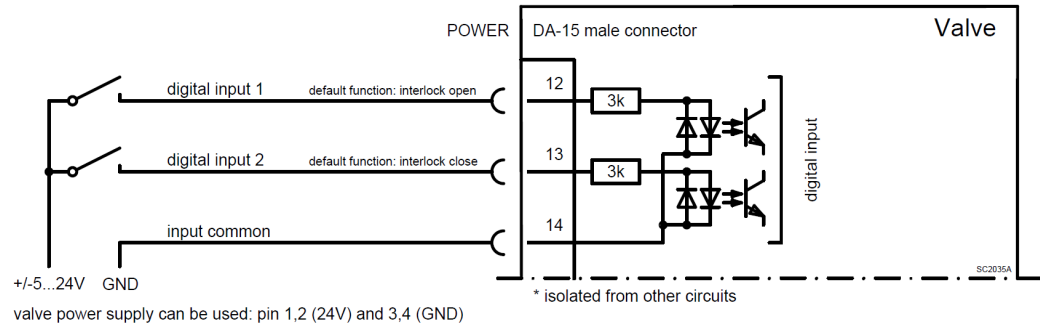

Pin	Default Function
12	INPUT 1 Interlock Open
13	INPUT 2 Interlock Close
14	COMMON

Configuration

Parameter	Description													
Enable	1 enables the input													
State	0 Not active 1 Active													
Functionality	0 Interlock Open 1 Interlock Close 2 Hold													
Inverted	<table border="1"> <thead> <tr> <th>Input</th> <th>State</th> <th>Function</th> </tr> </thead> <tbody> <tr> <td rowspan="2">0 Not Inverted</td> <td>Off</td> <td>0 Off</td> </tr> <tr> <td>On</td> <td>1 On</td> </tr> <tr> <td rowspan="2">1 Inverted</td> <td>Off</td> <td>1 Off</td> </tr> <tr> <td>On</td> <td>0 On</td> </tr> </tbody> </table>	Input	State	Function	0 Not Inverted	Off	0 Off	On	1 On	1 Inverted	Off	1 Off	On	0 On
Input	State	Function												
0 Not Inverted	Off	0 Off												
	On	1 On												
1 Inverted	Off	1 Off												
	On	0 On												



The INTERLOCK function has **priority** over the remote interface (HOLD does not)
INTERLOCK CLOSE has **priority** over INTERLOCK OPEN

Parameter location:

CPA EtherCAT Objects
Power Connector IO **2C01**
2C02

4.4.3.2 Digital output

Connection

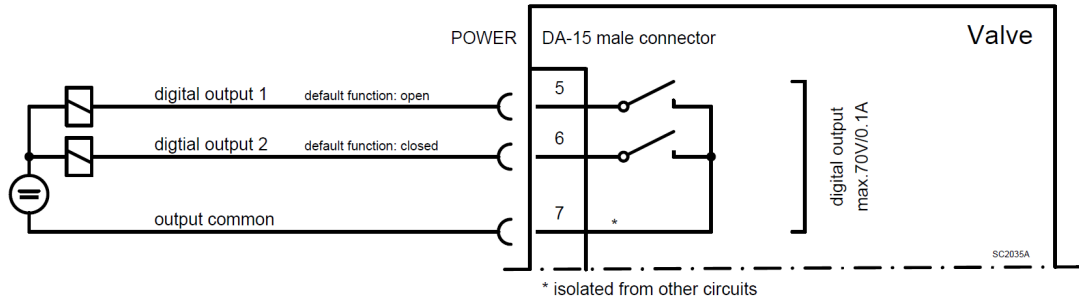

Pin	Default Function
5	OUTPUT 1 Open
6	OUTPUT 2 Closed
7	COMMON

Parameter, Configuration

Parameter	Description													
Enable	1 enables the output													
State	0 Not active 1 Active													
Functionality	0 OPEN valve is fully open 1 CLOSE valve is fully closed (isolated if valve has an isolation function) 2 HOLD valve is in hold state													
Inverted	<table border="1"> <thead> <tr> <th>Function</th> <th>State</th> <th>Output</th> </tr> </thead> <tbody> <tr> <td rowspan="2">0 Not Inverted</td> <td>inactive</td> <td>0 Off</td> </tr> <tr> <td>active</td> <td>1 On</td> </tr> <tr> <td rowspan="2">1 Inverted</td> <td>inactive</td> <td>1 On</td> </tr> <tr> <td>active</td> <td>0 Off</td> </tr> </tbody> </table>	Function	State	Output	0 Not Inverted	inactive	0 Off	active	1 On	1 Inverted	inactive	1 On	active	0 Off
Function	State	Output												
0 Not Inverted	inactive	0 Off												
	active	1 On												
1 Inverted	inactive	1 On												
	active	0 Off												

Parameter location:

CPA EtherCAT Objects
 Power Connector IO **2C03**
2C04

4.5 Power Up, Homing

After a restart homing is necessary to determine the plate position

Parameter	Description
Start Condition	Homing start option defines when the valve performs the homing procedure.
0 Standard	If valve is not in sealed state
1 Open Command	On an open command
2 Move Command	On any move command
3 At Startup	All the time
4 Homing Command	On homing command
5 Move Command without Close	On any move command except close command if the valve is closed
End Control Mode	This control mode is set after a successful homing.
2 Position	
3 Close	
4 Open	
5 Pressure Control	
End Position	In case the End Control Mode is set to 2 (Position), this parameter defines which position is set after successful homing.

Location:

CPA Parameters EtherCAT Objects
Valve.Homing **2120**

Followed description of the **standard setting**:

Valve position before power up:	Reaction of valve:
Closed (isolated)	Valve remains closed. Homing will be done when first movement command is received.
All other than closed (not isolated)	Valve do homing to initialize position. Display shows 'Ho' until homing is done Valve position after homing is closed

4.6 Power Down, Power Failure Option

4.6.1.1 Behavior in case of power failure

Valve position before power failure:	Reaction of valve:	
	Without Power Failure Option (PFO) 620 G / 620 A	With Power Failure Option (PFO) 620 H / 620 C
Closed (isolated)	Valve remains closed.	Valve will close or open depending on Power Failure Option configuration. Default is not defined. Display indicates F .
Valve open or in any intermediate position	The plate remains at the current position.	



All parameters are stored in a power fail save memory.

4.6.1.2 Power Failure Option

Power Failure option is circuit board that can store as much energy to close or open the valve in the event of a power failure.

Technical data

Charging Time	2 minutes max.
Durability	Up to 10 years @ 25°C ambient

These settings define what the valve is doing in case the power fails.



Valve must be equipped with the 'Power Failure Option'
[620 C or 620 H]

For PFO retrofit and other options refer to chapter: «Spare parts».

Parameter	Description
Enable	'True' enables the power fail reaction. 'False' there is no reaction on a power fail
State	0 Battery is Charging 1 Ready to Use 2 Active 3 Failure
Functionality	0 Open 1 Close
Delay	In seconds After this delay, the power failure reaction starts after the power failed. Helps to bridge a short power interruption.
Battery Voltage	Shows state of charge
Power Fail Cycles	Counts Power Failure

Location:

CPA Parameters EtherCAT Objects
Power Fail Option **2E00**

4.7 Service port, CPA software

The 'Service port is designed for 'Local operation' with the software CPA - Control Performance Analyzer.

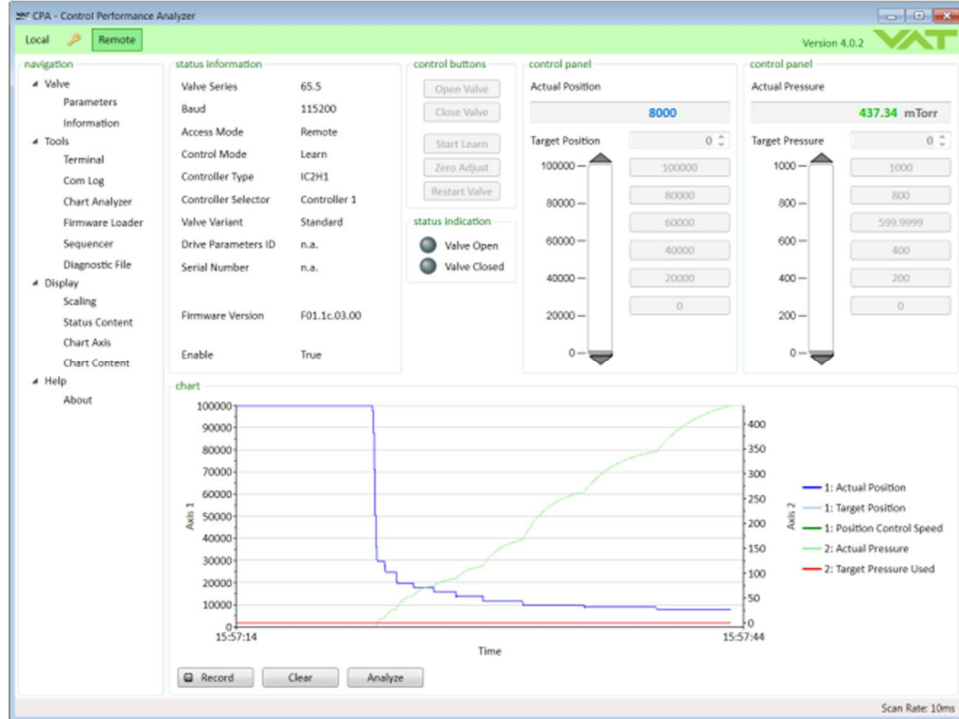

4.7.1 How to start

1. Connect service cable (USB A–B cable male-male) between PC and valve:

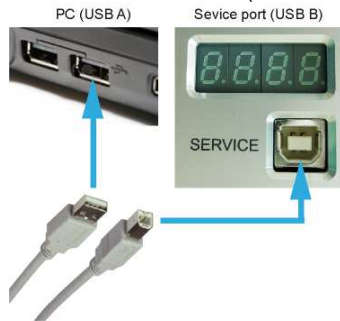

A drive opens:

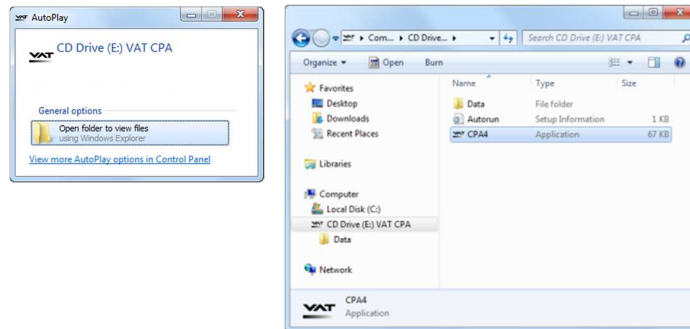

2. Double Click on 'CPA4.exe' to open the 'Control Performance Analyzer'

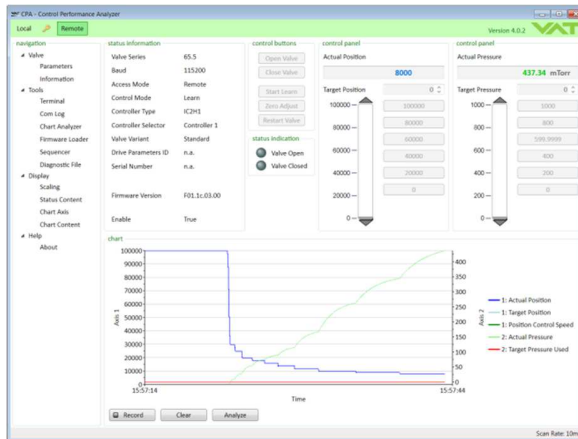

3. Click [Local] for Local operation to do configuration



When communication to service port is interrupted, the valve will change to remote operation. So when service cable will be disconnected or software will be shut down, the valve returns automatically to remote operation. This may result in an **immediate movement** of the valve depending on remote control.

4.7.2

Update

It is easy to update to the latest version of the CPA which can be found on the VAT homepage: <http://www.vatvalve.com/business/global-services/informations-and-downloads/control-performance-analyzer>

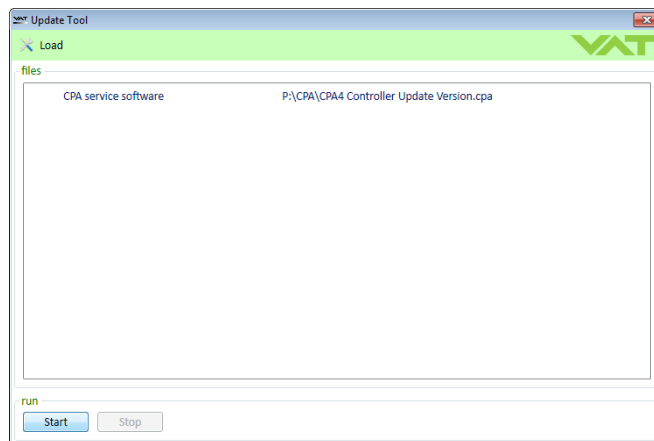

4.8 Display information

There is a 4 digit display located on the controller. It displays configuration, status and position information. For details refer to following tables.

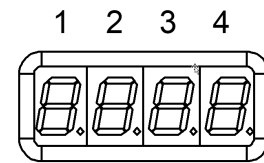

4.8.1 Power up

Description	Digit 1	Digit 2	Digit 3	Digit 4
<ul style="list-style-type: none"> 1st Power On: All dots are illuminated 	#	#	#	#
<ul style="list-style-type: none"> 2nd Valve series e.g. 67.0 		6	7	0
<ul style="list-style-type: none"> 3rd Firmware: generation.type e.g. 01.0C 	0	1	0	C
<ul style="list-style-type: none"> 4th Firmware: version.firmware e.g. 07.00 	0	7	0	0
<ul style="list-style-type: none"> 5th Controller configuration: e.g. 11.00 	Controller 1=H1 2=H2 3=H3 4=H4 5=H5 6=H6 7=H7	Interface 1=RS232/RS485 2=EtherCAT 3=DeviceNet 5=Logic	Options 00=none 01=SPS 02=PFO 03=Cluster 04=SPS & PFO 05=SPS & Cluster 06=PFO & Cluster 07=SPS & PFO & Cluster	
'Ho' homing is running	H	o		

4.8.2 Operation

Description / Mode	Digit 1	Digit 2	Digit 3	Digit 4
INIT (start up)	I	n.		
INIT (start up, leak tight)	I	n.		C
CLOSE	C.	C, 0...100 valve position C = closed, leak tight 0 = minimal 100 conductance = maximum opened		
OPEN	O.			
PRESSURE control	P.			
POSITION control	A.			
INTERLOCK Valve closed or open by digital input	I.			
HOLD (position frozen)	H.			
LEARN	L.			
SAFETY Refer to «Safety mode» for details.	S.			
POWER FAILURE	F.			

4.8.3 Error

Description	Digit 1	Digit 2	Digit 3	Digit 4
Error number (xyz)	E.	x	y	z
alternately (if error code exist)				
Error code		u	v	w



For Error number / code. Refer to «Trouble shooting» for details

4.9 Pressure Sensor

4.9.1 Mechanical connection requirements

To achieve fast and accurate pressure control a fast sensor response is required. Sensor response time: < 50ms. The sensor is normally connected to the chamber by a pipe. To maintain that the response time is not degraded by this connection it needs to meet the following requirements:

- Inner diameter of connection pipe: $\geq 10 \text{ mm}$
- Length of connection pipe: $\leq 300 \text{ mm}$

These conductance guidelines must include all valves and limiting orifices that may also be present. Make also sure that there is no obstruction in front of sensor connection port inside the chamber. The sensor should also be mounted free of mechanical shock and vibration. Dynamic stray magnetic fields may introduce noise to sensor output and should be avoided or shielded.

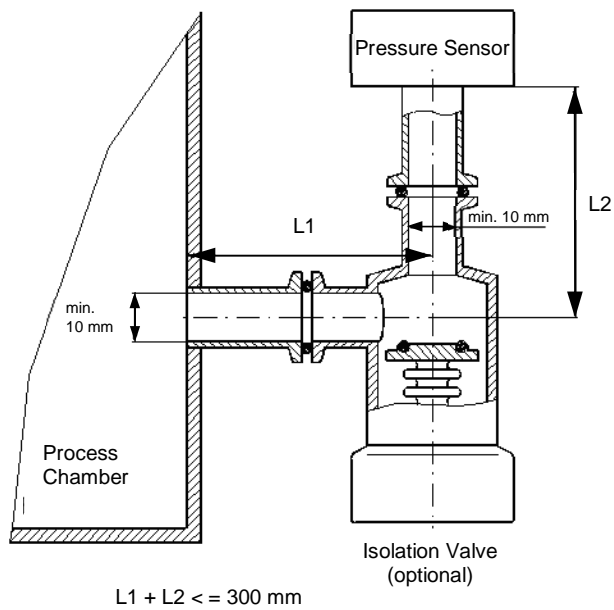

4.9.2 Configuration

The CPA window shows a good overview of the sensor settings:

- The valve supports 2 sensors.
- Zero Adjust is for offset compensation of linear sensors
- Crossover is automatic switch over between 2 linear sensors

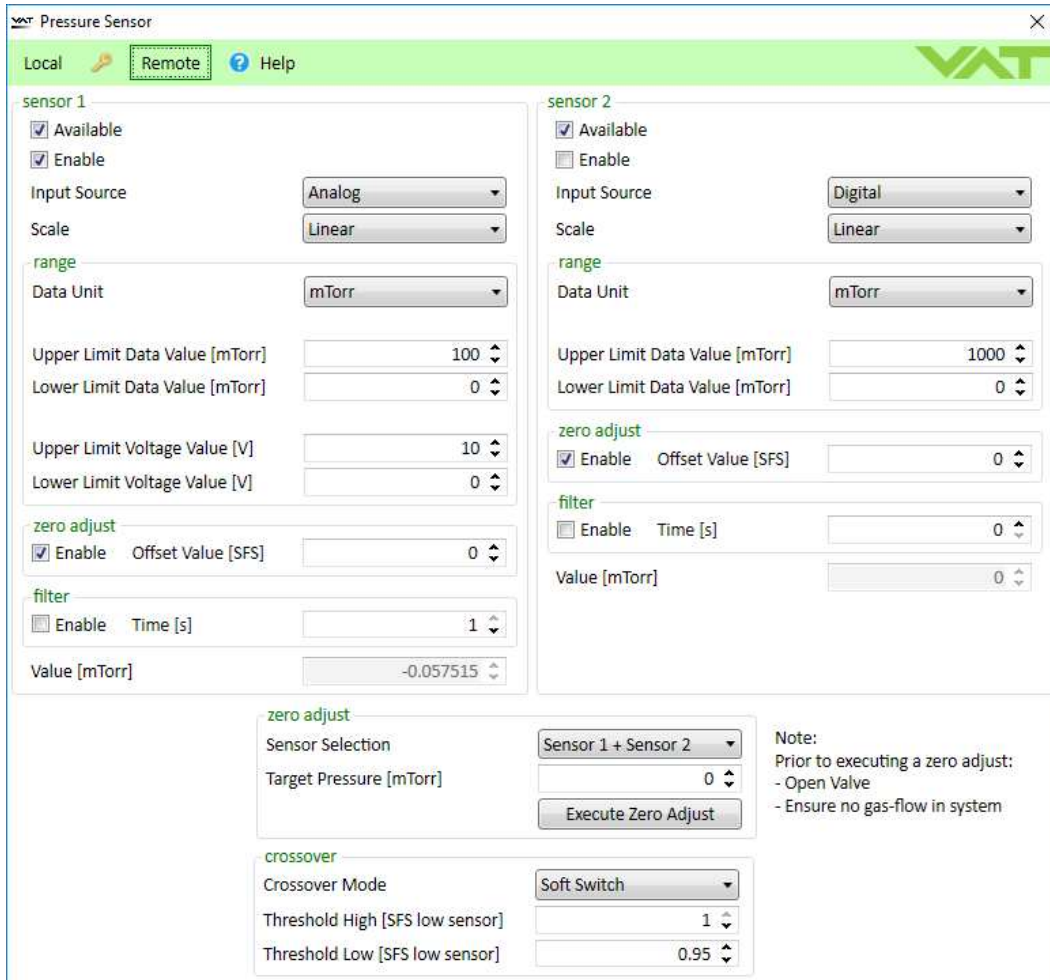

Parameter	Description
Available	Set to 'True' if a sensor is connected
Enable	Set to 'True' if the sensor signal is used for pressure control
Input Source	<p>'Analog' Sensor has an analog voltage interface and is direct connected to the valve.</p> <p>'Digital' Sensor has an EtherCAT interface and is connected to the EtherCAT bus</p> <p>'Simulation' Testing the valve and pressure control without being connected to the system</p>
Range.Scale	<p>Select type of the sensor signal</p> <p>'Linear'</p> <p>'Logarithmic'</p> <p>Most gauges are linear type gauges.</p>
Range.Data Unit	<p>Set the pressure data unit of the gauge:</p> <p>Pa, kPa, bar, mbar, Torr, mTorr, psia, psig</p>
Range.Upper Limit Data Value Range.Lower Limit Data Value	<p>Set the upper limit and lower limit of the gauge in the unit of "Range.Data Unit"</p> <p>Example for a 250mTorr linear sensor: Upper Limit = 250.0 Lower Limit = 0.0</p>
Range.Upper Limit Voltage Value Range.Lower Limit Voltage Value	<p>These parameters are only used for gauges with analog voltage interface.</p> <p>The values corresponds to Range.Upper Limit Data Value and Range Lower Limit Data Value</p> <p>Example: Upper Limit: 10.0V → 250mTorr Range Upper Limit Data Value Lower Limit: 0.0V → 0.0mTorr Range Lower Limit Data Value</p>
Filter.Enable	'True' enables the filter
Filter.Time	<p>Set filter time in the range of 0.0 to 1.0 second.</p> <p>Note: Filter delays the sensor signals which is detrimental for pressure control</p>

Location:

CPA Parameters	EtherCAT Objects
Pressure Sensor.Sensor 1	2401
Pressure Sensor.Sensor 2	2402
→ or use 'Pressure Sensor' window	

4.9.3 Crossover (2 sensor operation mode)

When two linear sensors are used (enabled) for pressure control the crossover handles the two pressure signals to building one system pressure (**Actual Pressure**).

Parameter	Description
Crossover Mode	Crossover between 2 sensors (see below)
Threshold High [SFS low sensor]	Defines the crossover area (see below)
Threshold Low [SFS low sensor]	The value is related to sensor full scale of low sensor (0.1 means 10% of sensor full scale of low sensor)
Delay	Switch over delay in Crossover Mode 'Hard Switch'

Crossover Mode Soft Switch

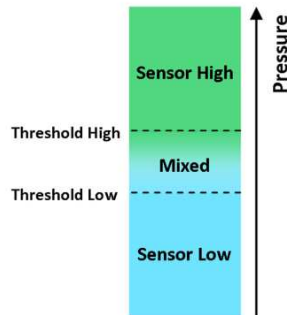

Within the threshold levels, the resulting measurement value is a summation of the two sensors signals with a proportional ratio of the two measured values.

When to use
This is the standard mode. Values of both sensors need to fit together in the crossover area, otherwise crossover effect result (nonlinearity). Therefore, sensor ratio should not be too high (about ≤ 100).

Crossover Mode Hard Switch

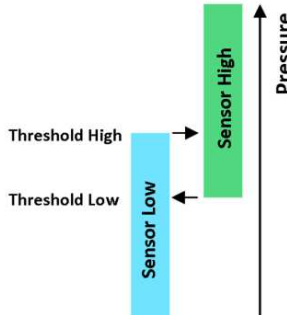

Switching between sensors according to the hysteresis threshold levels and an optional delay.

When to use
Preferred setting if the sensor signals do not fit together in the crossover area (for example if sensor ratio is high).

Crossover Mode Target Pressure

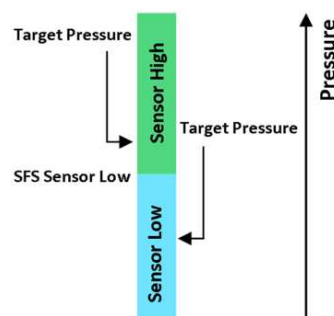

If target pressure is in the range of low sensor, low sensor is used; otherwise high range sensor.

When to use
As there is no switchover during pressure control while using this setting, undesired effects like nonlinearity or continuous switching between sensors don't occur.

Note
While in position control mode, 'Soft Switch' mode is used

Location:

CPA Parameters EtherCAT Objects
 Pressure Sensor.Crossover **2405**
 → or use 'Pressure Sensor' window

4.9.4 Zero Adjust

Zero Adjust allows for the compensation of the sensor offset voltage.

Note: A maximum offset voltage of +/- 1.4 V can be compensated.

Parameter	Description
Zero Adjust.Sensor Selection	Select the sensor for the zero adjust: <ul style="list-style-type: none"> • Sensor 1 + 2 • Sensor 1 • Sensor 2
Zero Adjust.Target Pressure	Normally this parameter is set to 0 in case the process chamber is fully evacuated (pressure <=1‰ of sensor full scale). If not you can align the sensor value to a known pressure (displayed on another readout in the system). In this case set Target Pressure to the known pressure. Note: Target Pressure is in the unit of pressure, see chapter «Scaling of Pressure and Position Values»
Zero Adjust.Execute	1: Start the zero adjust 2: Clear offset value After executing value return to 0
Sensor 1.Enable Sensor 2.Enable	0: It is not possible to execute a zero adjust. A present offset value is ignored 1: It is possible to execute a zero adjust. A present offset value is respected.
Sensor 1.Offset Value [SFS] Sensor 2.Offset Value [SFS]	Value which is deducted from the measured sensor value. The value is related to sensor full scale (0.1 means 10% of sensor full scale)

Location:

CPA Parameters	EtherCAT Objects
Pressure Sensor.Zero Adjust	2400
Pressure Sensor.Sensor 1.Zero Adjust	2401:0A
Pressure Sensor.Sensor 2.Zero Adjust	2402:0A
Pressure Sensor.Sensor 1.Zero Adjust	2401:0B
Pressure Sensor.Sensor 2.Zero Adjust	2402:0B

→ or use 'Pressure Sensor' window

Performing a zero adjust:

1. Turn the gas flow off
2. Fully open the valve
3. Wait until the sensor signal is not shifting anymore. Refer to manual of sensor manufacturer for warm up time.
4. Wait until process chamber is evacuated.



Do not perform Zero Adjust, if the base pressure of your vacuum system is higher than 1‰ of sensor full scale. We recommend disabling Zero Adjust function or using of Zero Adjust.Target Pressure other than 0.0 in this case. Otherwise incorrect pressure reading is the result.

5. Perform zero with setting of Zero Adjust.Execute to 1
6. Check parameter Actual Pressure if the pressure is shifted as expected

4.10 Pressure Control

4.10.1 Controller units

The valve has four identical pressure controller units. **Controller Selector** defines which unit is used for the pressure control.

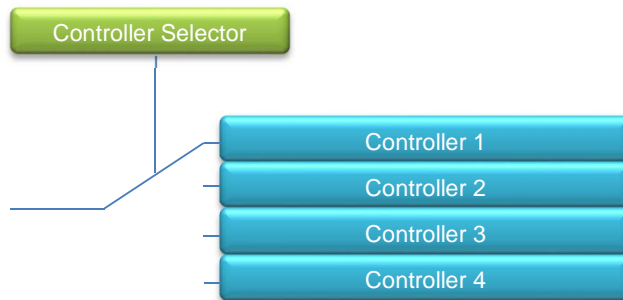

Most applications do not need more than one controller unit. But if the result of the pressure control does not meet the expectations, the different controller units can be an option for optimization: With the four controller units it's possible to use an own controller unit for a specific pressure working point. This controller unit can be parametrized optimally for this specific working point.

Normally the user selects the Controller according to his requirements.

The CPA window 'Pressure Control' shows a good overview over the configuration of the control units and the one that is selected:

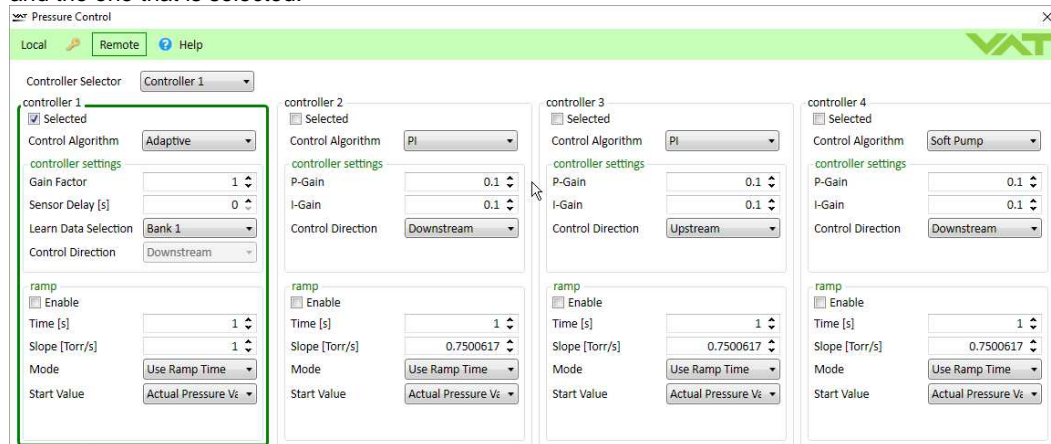

Alternatively, the **Automated Controller Selector** (see below) can select the controller depending on pressure ranges or control direction (up- / downwards).

Location:

CPA Parameters	EtherCAT Objects
Pressure Control	2300
Pressure Control.Controller Selector	2310
Pressure Control.Pressure Controller 1	2311
Pressure Control.Pressure Controller 2	2312
Pressure Control.Pressure Controller 3	2313
Pressure Control.Pressure Controller 4	2314

→ or use 'Pressure Control' window

4.10.2 Automated Controller Selector

Configure Automated Controller Selector for either different pressure ranges or up- / downwards control direction.

Each of the 4 Controllers can be assigned to specific operation conditions. The Automated Controller Selector can select one of the 4 Controllers depending on

- Target Pressure (**Mode:** *Threshold*)
- Up- or Downwards Control (**Mode:** *Pressure Direction*)



If not all controllers are assigned to the automated controller selector and one of the not assigned ones is manually selected by the user, this controller remains active until one of the assigned ones is selected by the user.

Mode: *Threshold*
Threshold Condition: *Lower or Equal*

Controller is **selected** based on **Target Pressure**. For **each controller** a **Threshold** value can be defined. So each controller gets an **assigned pressure range**. A controller remains active as long as target pressure is in his range. If target pressure changes to a higher or lower range the respective controller will take over.

If the **Target Pressure** is higher than the highest **Threshold**, the highest one is taken.

Mode: Threshold
Controller Selector Bitmap: 15
Threshold Condition: Lower or Equal
Controller 1 Threshold: 100 [mbar]
Controller 2 Threshold: 200 [mbar]
Controller 3 Threshold: 400 [mbar]
Controller 4 Threshold: 1000 [mbar]

Mode: *Threshold*
Threshold Condition: *Equal*

Controller is **selected** based on **Target Pressure**. For **each controller** a **Threshold** value can be defined. So each controller gets a **defined pressure** to be activated. A controller remains active as long as the target pressure is not equal with the pressure threshold for a different controller.

Mode: Threshold
Controller Selector Bitmap: 15
Threshold Condition: Equal
Controller 1 Threshold: 100 [mbar]
Controller 2 Threshold: 200 [mbar]
Controller 3 Threshold: 400 [mbar]
Controller 4 Threshold: 1000 [mbar]

Mode: *Pressure Direction*
Controller Pressure Rising: *Controller 1...4*
Controller Pressure Falling: *Controller 1...4*

Controller is **selected** based on **pressure control direction**. For **each direction** a **Controller** can be defined.

Parameters:

Parameter	Description
Enable	Switches on/off the function
Mode	<i>0 Threshold</i> <i>1 Pressure Direction</i>
Controller Selector Bitmap	Used if Mode = <i>Threshold</i> Defines which controllers are automatically selected
Threshold Condition	Used if Mode = <i>Threshold</i> <i>0 Lower or Equal</i> <i>1 Equal</i> The Thresholds are related to Target Pressure
Controller 1 Threshold Controller 2 Threshold Controller 3 Threshold Controller 4 Threshold	Used if Mode = <i>Threshold</i> The Thresholds are related to Target Pressure
Controller Pressure Rising Controller Pressure Falling	Used if Mode = <i>Pressure Direction</i> Select one Controller for up control and one for down control <i>0 Controller 1</i> <i>1 Controller 2</i> <i>2 Controller 3</i> <i>3 Controller 4</i>

Location:

CPA Parameters EtherCAT Object
 Pressure Control.General Settings.Automated Controller Selector **2333**

4.10.3 Control algorithm

4.10.3.1 Overview

Adaptive This is the most dynamic control algorithm. Before using adaptive control algorithm, a special procedure called "learn" must be executed first (see chapter below). The valve will observe the behavior of the vacuum system by moving the valve to different positions. During the learn procedure the valve performs an internal parameter estimation correspondent to the vacuum system.

Note: The adaptive pressure control work at its best if the conditions (mainly gas flow) are close the conditions at the learn procedure.

Adaptive control algorithm requires a **linear** sensor signal. In case of using a logarithmic sensor the signal has to be linearized or PI algorithm has to be used.

PI This is a solid algorithm for pressure control. The performance will be behind the adaptive control algorithm. But if the condition varies a lot, it's possible that the adaptive control algorithm does not work properly so the PI algorithm provides the best result.

Soft Pump Is a modified PI control algorithm to pump down from atmospheric pressure. This control algorithm has been optimized to prevent that the pressure in the chamber is decreasing too fast at the start (to reduce occurrence of an undershoot).

4.10.3.2 Choose correct control algorithm

System Configuration	Constant gas flow available		Constant gas flow not available
	Tv* ≤ 500 sec	Tv* > 500 sec	
Downstream 	Adaptive		PI
Upstream 			PI
Soft Pump			Soft Pump



* Use the formula below to define the applicable pressure control algorithm.

$$Tv = \frac{p_{SFS} \cdot CV}{q_L}$$

q_L gasflow for learn [mbar/s]
p_{SFS} sensor full scale pressure [mbar]
Tv* Vacuum time constant [sec]
CV Chamber Volume [l]

4.10.4 Adaptive algorithm

This control algorithm may be used for downstream pressure control.

Before using adaptive control algorithm, a special procedure called “learn” must be executed first (see chapter below).

4.10.4.1 Control Parameter

Parameter	Description
Gain Factor	Main parameter to adapt the performance of the pressure control algorithm. A higher gain results in a faster response, higher over- / undershoots of pressure. A lower gain results in slower response, lower over- / undershoot of pressure.
Sensor Delay	For compensation of delays during the pressure detection. Pipes and orifices for sensor attachment can cause delays in response time and could impact badly the pressure control stability. By adapting this parameter to the approximate delay time stability problems can be reduced. But control response time will be slowed down by this measure.
Learn Data Selection	There are up to 4 different learn data sets available. Select which Learn Data set the adaptive controller shall use for pressure control.
Ramp	This parameter defines the time that is used to change to the new setpoint. Therefore also called setpoint ramp. It helps especially in pressure decrease situations to reduce undershoot of pressure. See chapter «Pressure Ramp» for detailed description.
Valve Speed	This reduces the motion speed of the valve. Normally it should not be necessary to adapt it. However, in special control situation it may help to achieve the required result. See chapter «Pressure Control Speed» for detailed description.

4.10.4.2 Learn

LEARN adapts the PID controller of the valve to the vacuum system and its operating conditions. LEARN must be executed only once during system setup. The LEARN routine determines the characteristic of the vacuum system. Based on this, the PID controller is able to run fast and accurate pressure control cycles.

This characteristic depends on various parameters such as chamber volume, conductance and flow regime. Therefore it must be performed with a specific gas flow according to instruction below.

The result of LEARN is a pressure versus valve position data table. This table is used to adapt the PID parameters. The data table is stored in the device memory which is power fail save. The data table can be up-/downloaded via 'Control Performance Analyzer' software or remote interface. Due to encoding the data may not be interpreted directly.

By an OPEN VALVE, CLOSE VALVE, POSITION CONTROL or PRESSURE CONTROL command the routine will be interrupted.

Parameter	Description
Bank Selection	Select one of four learn bank to place the result of the learn procedure. Note: Be sure pressure controller select this learn bank!
Pressure Limit [SFS]	Limit pressure to which pressure the learn shall be executed. The value is related to the sensor full scale of high sensor. 1.0 means the whole pressure range of the sensors
Open Speed	Define the speed for opening the valve during the learn procedure. May be necessary to prevent a pump from crashing. 1.0 means full speed
Status	State of the current learn 0: Not Started 1: In Progress 2: Completed Successfully 3: Aborted 4: Failed
Warning Info	Warning of current learn procedure: Bit 0: Learn is running Bit 1: Checksum error (learn data corrupt) Bit 2: Learn procedure terminated by user Bit 3: Pressure at position open > 50% of pressure limit Bit 4: Pressure at minimal conductance position < 10 % of pressure limit Bit 5: Pressure falls while move valve in direction of close Bit 6: Pressure at open position does not match pressure of previous open Bit 7: Learn procedure terminated by program Bit 8: Pressure <= 0 at open position (no gas flow set?)

Location:

CPA Parameters	EtherCAT Objects
Pressure Control.Adaptive Learn	2350
→ or use 'Adaptive Learn' and 'Adaptive Learn Data' window	

4.10.4.2.1 Execute a learn procedure

1. Set specific gas flow according to calculation below or the calculation in the CPA → '**Adaptive Learn**' window:

Learn does not need to be performed with the process gas. Instead N₂ or Ar may be used.
2. Set parameter **Bank Selection**, if only one learn is used take Bank 1. Be sure that the pressure controller also selects this learn bank!
3. Reduce **Open Speed** if it is critical for the chamber if the pressure drops rapidly when the valve is opened.
4. Set a **Pressure Limit [SFS]** limit if sensor full scale cannot or should not be reached.
5. Set parameter **Controller Mode** to **LEARN**.
6. Wait until the **Controller Mode** leaves the **LEARN** state → Learn is finished
7. Check if the learn was successful by checking if **Status** shows value 2 (=Completed Successfully). In best case **Warning Info** shows no warning.



- Sensor signal must not shift during LEARN. Wait until sensor signal is stable before LEARN is performed. Learn may take several minutes.
- Do not interrupt the routine as a single full run is required to ensure fast and accurate pressure control.
- The PID controller covers 5% to 5000% of the gas flow which was used for learn.

CPA window '**Adaptive Learn**'

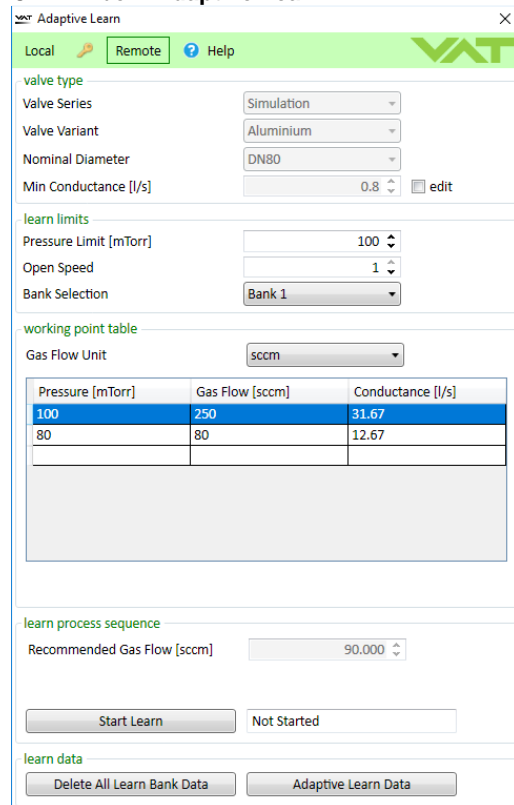

Local Remote Help 

valve type
 Valve Series: Simulation
 Valve Variant: Aluminium
 Nominal Diameter: DN80
 Min Conductance [l/s]: 0.8 edit

learn limits
 Pressure Limit [mTorr]: 100
 Open Speed: 1
 Bank Selection: Bank 1

working point table
 Gas Flow Unit: sccm

Pressure [mTorr]	Gas Flow [sccm]	Conductance [l/s]
100	250	31.67
80	80	12.67

learn process sequence
 Recommended Gas Flow [sccm]: 90.000

Start Learn Not Started

learn data
 Delete All Learn Bank Data Adaptive Learn Data

4.10.4.2.2 Gasflow calculation for Learn

Do not apply a different gasflow for learn than determined below. Otherwise pressure control performance may be insufficient. Required pressure / flow regime must be known to calculate the most suitable learn gas flow for a specific application.

- At first it is necessary to find out about the required control range respectively its conductance values. Each working point (pressure / flow) must be calculated with one following formulas. Choose the applicable formula depending on units you are familiar with.

$$C_{WP} = \frac{1000 \cdot q_{WP}}{p_{WP}}$$

C_{WP} required conductance of working point [l/s]
 q_{WP} **gasflow** of working point [**Pa m³/s**]
 p_{WP} **pressure** of working point [**Pa**]

$$C_{WP} = \frac{q_{WP}}{p_{WP}}$$

C_{WP} required conductance of working point [l/s]
 q_{WP} **gasflow** of working point [**mbar l/s**]
 p_{WP} **pressure** of working point [**mbar**]

$$C_{WP} = \frac{q_{WP}}{78.7 \cdot p_{WP}}$$

C_{WP} required conductance of working point [l/s]
 q_{WP} **gasflow** of working point [**sccm**]
 p_{WP} **pressure** of working point [**Torr**]

- Out of these calculated conductance values choose the lowest.

$$C_R = \min(C_{WP1}, C_{WP2}, \dots, C_{WPn})$$

C_R required lower conductance [l/s]
 C_{WPx} required conductance of working points [l/s]



To make sure that the valve is capable to control the most extreme working point verify that $C_R \geq C_{min}$ of the valve (refer to «Technical data»).

- Calculate gasflow for learn. Choose the applicable formula depending on units you are familiar with.

$$q_L = \frac{p_{SFS} \cdot C_{min}}{1100}$$

q_L gasflow for learn [**Pa m³/s**]
 p_{SFS} sensor full scale pressure [**Pa**]
 C_{min} min. controllable conductance of valve [l/s], (refer to «Technical data»)

$$q_L = \frac{p_{SFS} \cdot C_{min}}{1.1}$$

q_L gasflow for learn [**mbar l/s**]
 p_{SFS} sensor full scale pressure [**mbar**]
 C_{min} min. controllable conductance of valve [l/s], (refer to «Technical data»)

$$q_L = 71 \cdot p_{SFS} \cdot C_{min}$$

q_L gasflow for learn [**sccm**]
 p_{SFS} sensor full scale pressure [**Torr**]
 C_{min} min. controllable conductance of valve [l/s], (refer to «Technical data»)

4.10.4.3 Tuning

Normally the default settings will result in good pressure control performance. For some applications tuning may be required to improve performance. The tuning procedures for each parameter (grey boxes) and its default values are described separately below. Strictly keep the procedure order.

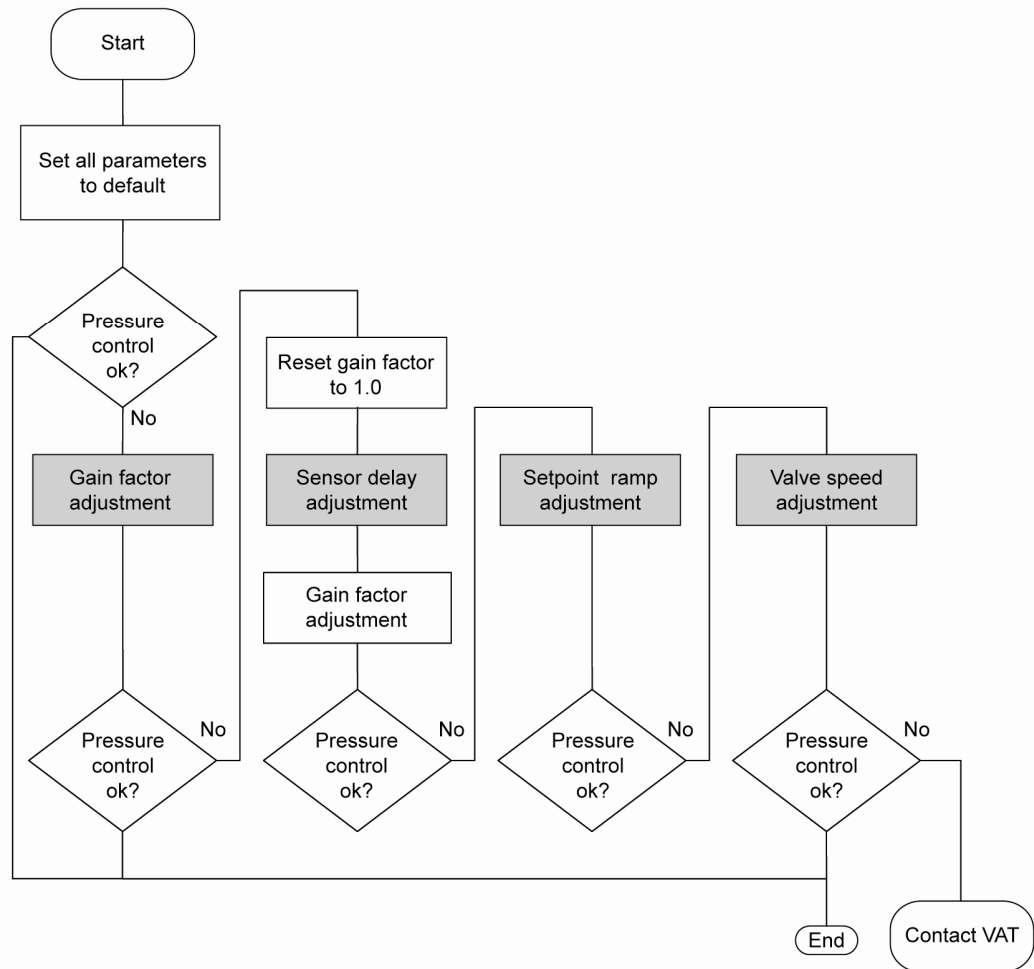

In case further support is requested, the following information is required:

- Go to 'Tools / Create Diagnostic File' in 'Control Performance Analyzer' and save file
- Pressure / flow / gas conditions to be controlled
- Chamber volume
- Pumping speed (l/s) and pump type (e.g. turbo pump)
- System description
- Problem description

Send diagnostic file with and all required information to tuning-support@vat.ch

4.10.4.3.1 Gain Factor adjustment

The Gain Factor effects: **Stability, Response time**

Adjustment range is from 0.0001 to 100

- Higher gain results in: faster response, higher over- undershoot of pressure
- Lower gain results in: slower response, lower over- undershoot of pressure

Adjustment procedure:

1. Start with Gain Factor 1.0
2. Open valve.
3. Control a typical pressure / flow situation.
4. Repeat from step 2 with lower (higher) Gain Factors until optimal pressure response is achieved and stability is ok.



Normally adjustments in the range from 0.42 to 7.5 should lead to good results. In case lower factors are required, you may need to improve sensor connection. Refer to «Requirements to sensor connection».

4.10.4.3.2 Sensor Delay adjustment

Sensor Delay adjustment effects: **Stability**

Adjustment range is from 0.0 to 1.0sec

Pipes and orifices for sensor attachment delay response time and so badly impact pressure control stability.

By adapting this parameter to the approximate delay time stability problems can be reduced. But control response time will be slowed down by this measure.



Whenever possible sensors should be attached to the chamber according to «Requirements to sensor connection». This is the most effective measure against stability issues. If your gauge attachment fulfills these criteria do not use this parameter.

Adjustment procedure:

1. Start with Gain Factor 1.0 and sensor delay 0s.
2. Open valve.
3. Control a typical pressure / flow situation.
4. Repeat from step 2 with higher sensor delays until best possible stability is achieved.
5. Adjustment Gain Factor again. Refer to «Gain factor adjustment».

4.10.4.3.3 Setpoint Ramp adjustment

Setpoint Ramp effects: **Undershoot of pressure, Response time**

This parameter defines the time that is used to decrease / raise pressure to the next setpoint (target pressure). Especially in pressure decrease situations at low flows pressure response can be improved much by adapting setpoint ramp time.

Pressure chart

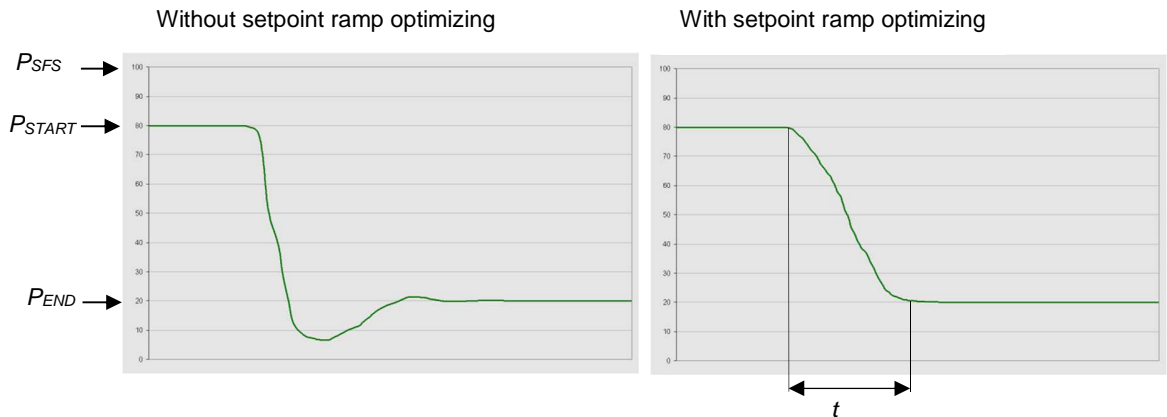

$t = \text{Setpoint Ramp}$

Adjustment procedure:

1. Start with optimal Gain Factor and sensor delay time according to preceding tuning steps.
2. Control a typical pressure / flow situation.
3. Control a lower pressure.
4. Repeat from step 2 with longer setpoint ramps until best response is achieved.
5. Verify pressure control response for a setpoint raise situation.



In case a long ramp time is required to get optimal performance for pressure decrease situations it may be of advantage to apply a different controller (setting) for decrease / raise control situations.

For details of ramp configuration / setup refer to chapter «Pressure Ramp».

4.10.4.3.4 Valve Speed adjustment

Valve speed effects: **Response time**



Normally best pressure control response is achieved with maximum valve speed. In particular applications it may be of advantage to have a slower valve response.

Adjustment procedure:

1. Use optimal Gain Factor, sensor delay time and setpoint ramp according to preceding tuning steps.
2. Open valve.
3. Control a typical pressure / flow situation.
4. Repeat from step 2 with slower Pressure Control Speed until required response is achieved.

For details refer to chapter «Pressure Control Speed».

4.10.5 PI algorithm

This control algorithm may be used for downstream or upstream pressure control depending on configuration.

PI controller mode is used if for any reason (e.g. too long system time constant) the adaptive control mode does not provide satisfying control performance in downstream control mode.

In PI controller mode the parameters P-Gain and I-Gain have to be set according to the systems characteristics. The best set of parameters can be found by using the empiric method below.

4.10.5.1 Control Parameter

Parameter	Description
P-Gain	The P-Gain is the proportional factor of the fixed control algorithm. A higher P-Gain results in faster response, higher over- / undershoot of pressure.
I-Gain	The I-Gain is the integral factor. The I-Gain helps to reach the target pressure exactly.
Direction	The Control Direction defines the type of application, if the valve is mounted in downstream or upstream. Downstream means the valve is after the chamber and before the pump. Upstream, valve is mounted before chamber and pump.
Ramp	This parameter defines the time that is used to change to the new setpoint. Therefore also called setpoint ramp. It helps especially in pressure decrease situations to reduce undershoot of pressure. See chapter «Pressure Ramp» for detailed description.
Valve Speed	This reduces the motion speed of the valve. Normally it should not be necessary to adapt it. However, in special control situation it may help to achieve the required result. See chapter «Pressure Control Speed» for detailed description.

4.10.5.2 Tuning

The PI parameters of the pressure controller require correct adjustment. These parameters must be set once during system setup and are stored in the device memory which is power fail save. Based on the PI controller configuration, the valve is able to run fast and accurate pressure control cycles. The PI parameters can be evaluated using below instruction.



- In downstream control mode valve will move towards open when current pressure is higher than set point.
- In upstream control mode valve will move towards close when current pressure is higher than set point.

In case further support is requested, the following information is required:

- Go to 'Tools / Create Diagnostic File' in 'Control Performance Analyzer' and save file
- Pressure / flow / gas conditions to be controlled
- Chamber volume
- Pumping speed (l/s) and pump type (e.g. turbo pump)
- System description
- Problem description

Send diagnostic file with and all required information to tuning-support@vat.ch

4.10.5.2.1 Pressure and gas flow for optimization

A PI controller delivers the best results for a certain working point (pressure/gas flow). If there is only one working point, this pressure and gas flow has to be used for optimizing P and I-Gain. If there are several working points that have to be covered, the pressure for optimizing is the medium pressure between highest and lowest pressure to be controlled, the gas flow for optimizing is the highest flow out of all working points.

Two different pressure set points are necessary for optimization.

Set point 1 (SP1) is the pressure for optimizing as determined above.

Set point 2 (SP2) is about 10 - 20% lower than SP1.

Example: pressure range: 4 – 10 Torr

Flow range: 2 – 4 slm

Pressure set points and gas flow for optimization:

SP1 = 7 Torr

SP2 = 6 Torr

Gas flow = 4 slm

4.10.5.2.2 Optimizing P-Gain

While optimizing P-Gain, the gas flow determined above has to be constant all the time.

Start optimization with P-Gain set to 1.0 and I-Gain set to 0.0. Set chamber pressure to SP2, wait until the pressure is stable. Set pressure to SP1. If the transition from SP2 to SP1 results in a significant pressure over shoot or even does not stabilize at all, the P-Gain is too high. If there is no over shoot and the pressure reaches SP1 asymptotically and very slow, P-Gain is too low. The optimal P-Gain value is found if the transition from SP2 to SP1 results in a slight pressure over shoot. It does not matter if there is still a deviation between SP1 and actual pressure.

Example:

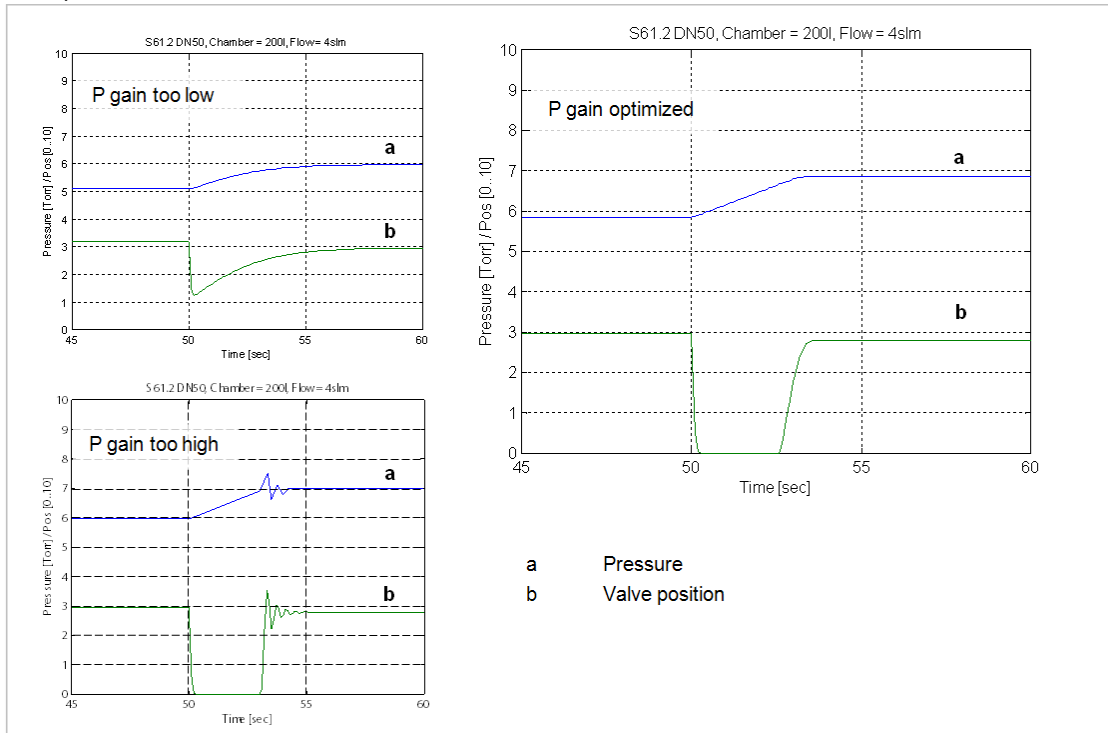

4.10.5.2.3 Optimizing I-Gain

While optimizing I-Gain, the gas flow determined above has to be constant all the time.

Start with P-Gain set to half of the value found when optimizing P-Gain and set I-Gain to 1.0. Keep the P-Gain constant.

Set chamber pressure to SP2, wait until the pressure is stable. Set pressure to SP1. If the transition from SP2 to SP1 results in a significant pressure over shoot or if the valve position does not stabilize, I-Gain is too high. If the transition results in a slow asymptotical pressure rise and there is still a constant deviation to SP2, the I-Gain is too low.

The optimal value for I-Gain is found if the transition from SP2 to SP1 result in just a slight pressure over shoot, a stable valve position and the actual pressure matches SP2 exactly.

Example:

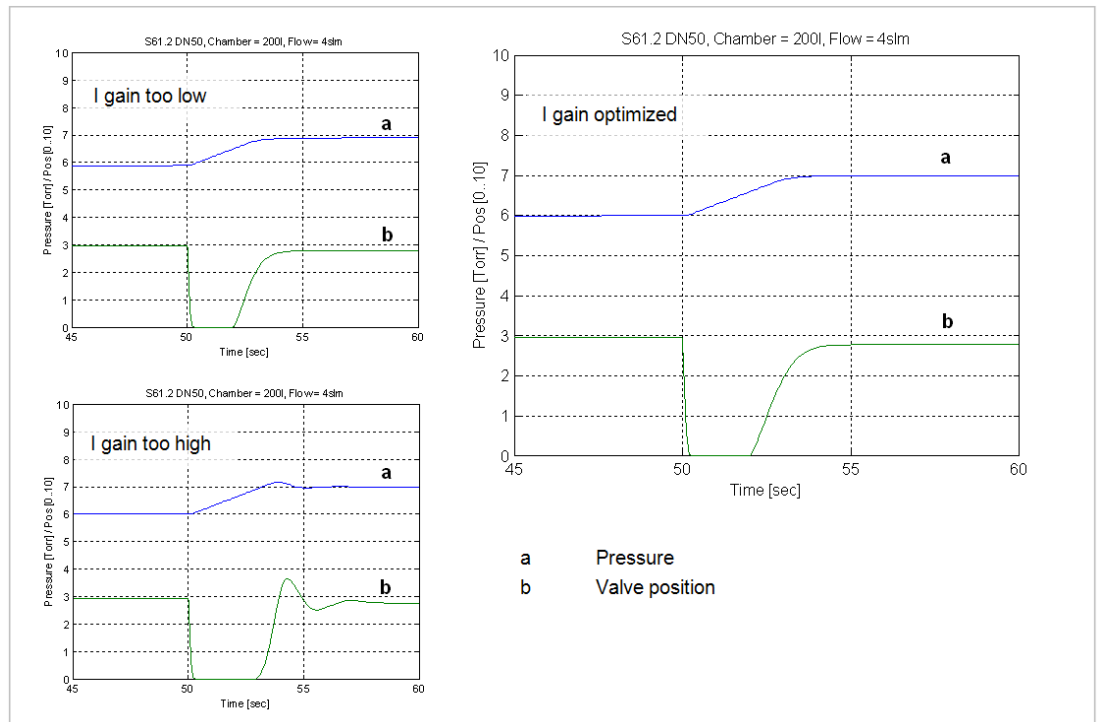

Check control performance over the whole control range with parameters above.

4.10.5.2.4 Ramp adjustment

This parameter defines the time that is used to decrease / raise pressure to the next setpoint (target pressure). Especially in pressure decrease situations at low flows pressure response can be improved much by adapting setpoint ramp time.

Pressure chart

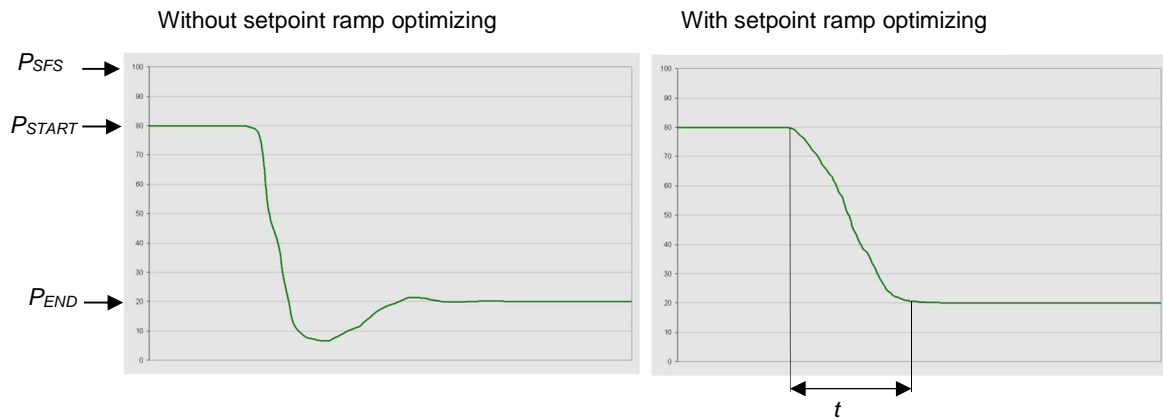

$t = \text{Ramp}$

Adjustment procedure:

1. Start with optimal P / I-Gain according to preceding tuning steps.
2. Control a typical pressure / flow situation.
3. Control a lower pressure.
4. Repeat with longer ramps until best response is achieved.
5. Verify pressure control response for a setpoint raise situation.



In case a long ramp time is required to get optimal performance for pressure decrease situations it may be of advantage to apply a different controller (setting) for decrease / raise control situations.

For details of ramp configuration / setup refer to chapter «Pressure Ramp».

4.10.6 Soft pump algorithm

This control algorithm may be used to control pressure ramps during pump down.

4.10.6.1 Control Parameter

Parameter	Description
P-Gain	The P-Gain is the proportional factor of the fixed control algorithm. A higher P-Gain results in faster response, higher over- / undershoot of pressure.
I-Gain	The I-Gain is the integral factor. The I-Gain helps to reach the target pressure exactly.
Ramp	This parameter defines the time/profile for the soft pump. See chapter «Pressure Ramp» for detailed description.
Valve Speed	This reduces the motion speed of the valve. Normally it should not be necessary to adapt it. However, in special control situation it may help to achieve the required result. See chapter «Pressure Control Speed» for detailed description.

4.10.6.2 Tuning

4.10.6.2.1 Optimizing P-Gain

Start optimization with P-Gain set to 0.1 and I-Gain set to 0.0.

The pump down routine has to be controlled as follows:

- Move control valve into close position
- Start pump down by opening the pump isolation valve or starting the pump
- Send the pressure set point to the valve controller.

While pumping down chamber pressure and valve position should be data logged to compare the actual pump down curve with the ideal straight pump down line.

If the pressure follows the ideal pump down line with significant delay, the P-Gain is too low.

If the pressure oscillates around the ideal pump down line or if the valve position oscillates, P-Gain is too high.

P-Gain is optimized if the pressure follows the ideal pump down line closely and the valve position is not oscillating at all.

Example:

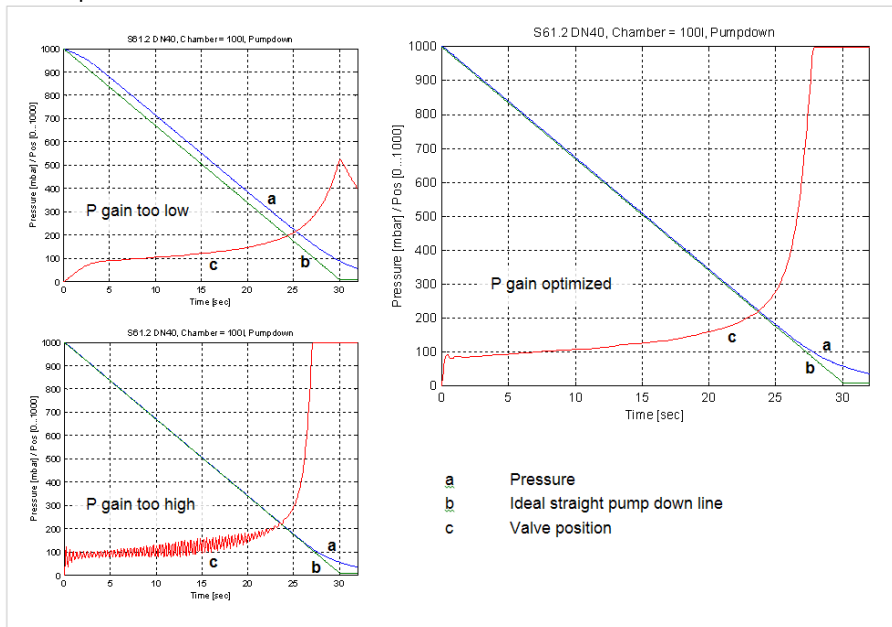

4.10.6.2.2 Optimizing I-Gain

I-Gain is responsible to reach the setpoint. If reaching setpoint is not important (e.g. setpoint is 0) leave the I-Gain at 0. Otherwise start with P-Gain set to half of the value found when optimizing P-Gain and set I-Gain to 0.1. Keep the P-Gain constant. Start again the pump down. Check how the pressure reaches the setpoint:

If the setpoint is reached too slowly increase I-Gain

If there is an undershoot increase I-Gain

4.10.6.2.3 Ramp definition

This parameter defines the time / ramp that is used to decrease the pressure to the target pressure. The ramp is the essential definition for the soft pump function.

For details of ramp configuration / setup refer to chapter «Pressure Ramp» or «Profile Ramp». «Profile Ramp» is a more sophisticated function than «Pressure Ramp» and supports segmented ramps.

4.10.7 Pressure Ramp

Basically, the pressure ramp is used to limit the rate of pressure change.

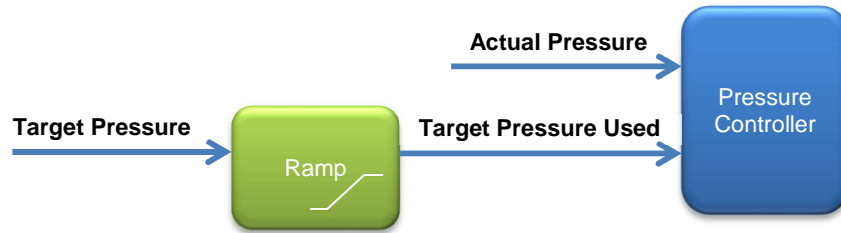

4.10.7.1 Configuration

Parameter	Description
Enable	Activate / Deactivate pressure target ramp
Mode	0: Use <i>Ramp Time</i> 1: Use <i>Ramp Slope</i> See description below
Time	Target reach time in seconds (Used if Mode = 0)
Slope	Limit the rate of pressure change in pressure per seconds (Used if Mode = 1)
Type	0: Linear 1: Logarithmic 2: Exponential Not supported yet
Start Value	0: Previous Ramp Value 1: Actual Pressure Value

4.10.7.2 Mode

Time

Unit: seconds

Time is constant, slope varies

Example: 2 sec

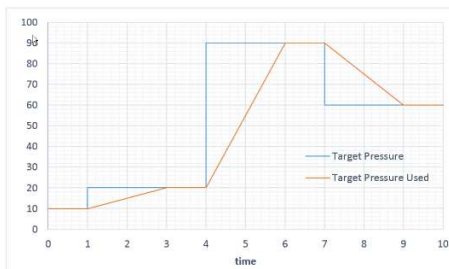

Slope

Unit: Pressure / seconds

Slope is constant, time varies

Example: 10mTorr/second

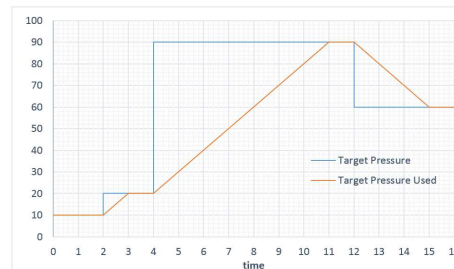

4.10.7.3 Type

Linear

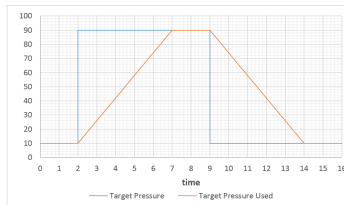

Logarithmic

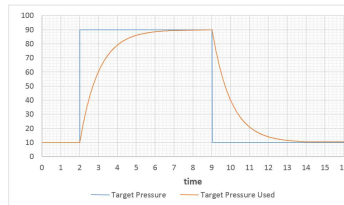

Exponential

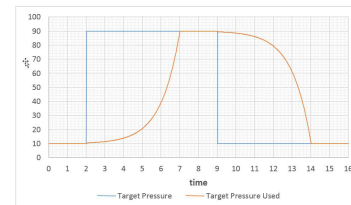



4.10.7.4 Applications Examples

Soft pump

Ramp Mode = Time
Ramp Time = 100 sec
Ramp Type = Linear
Target Pressure = 0

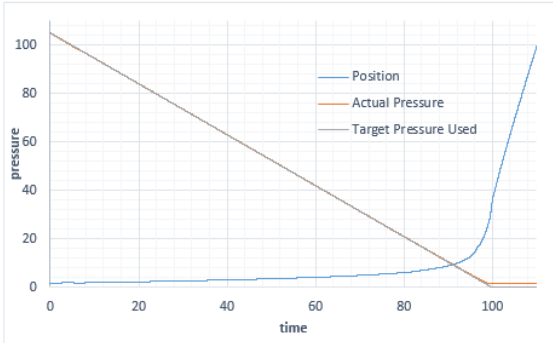

Minimize pressure over- or undershoots

New Target Pressure without pressure ramp

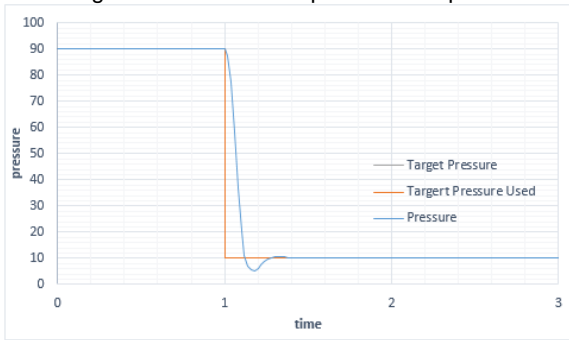

New Target Pressure with pressure ramp

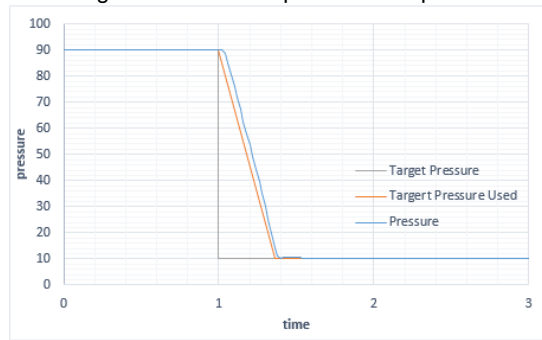

Smoothing a staircase

Pressure ramp with new target pressure to the valve every second is smoothed by a 1 sec internal ramp
Ramp Time = 1sec

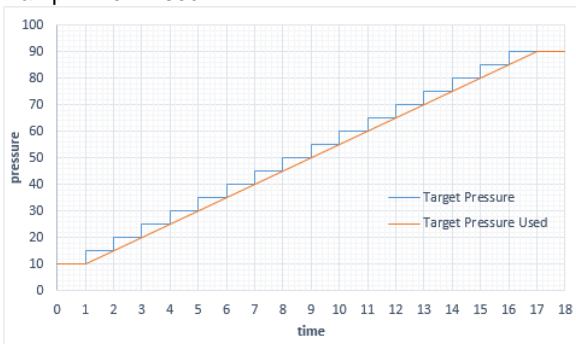

4.10.8 Profile Ramp

Profile Ramp is a **Target Pressure** ramp that depends on pressure ranges (segments). It is mainly used to create soft pumping or soft venting profiles.

If **Profile Ramp** is activated then the **Pressure Ramp** function is disabled for the respective controller(s).

To design a profile, the segments (pressure ranges) must be defined. A segment is defined by the pressure **Threshold** and the **Slope**. It is possible to define up to 10 segments.

Example: Ramp Profile with 3 segments

Segment Nr	Threshold mBar*	Resulting Segment mBar*	Slope mBar*/sec
1	1000	500 to 1000	50
2	500	200 to 500	100
3	200	0 to 200	200

Result is a Target Pressure Ramp (**Target Pressure Used**) with different slopes depending on pressure ranges:

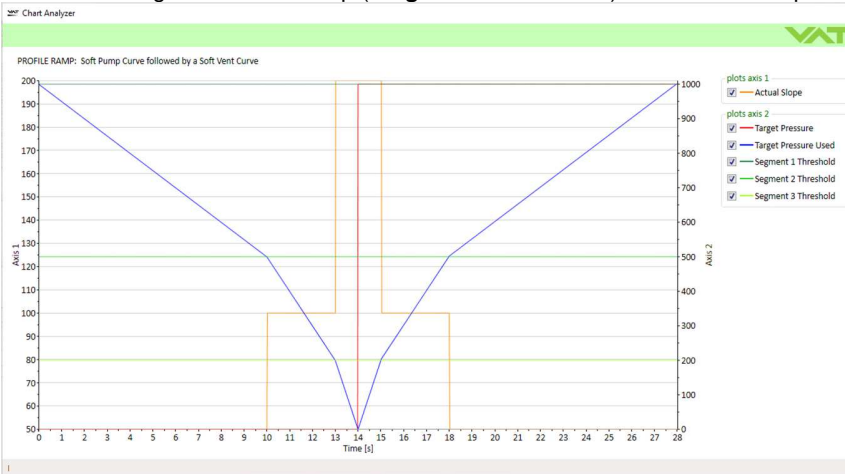

Parameters:

Parameter	Description
Enable	Switches on/off the function
Threshold Mode	Defines which pressure the threshold refers to

0 Actual Pressure

Change happens if **Actual Pressure** reaches the **Threshold**

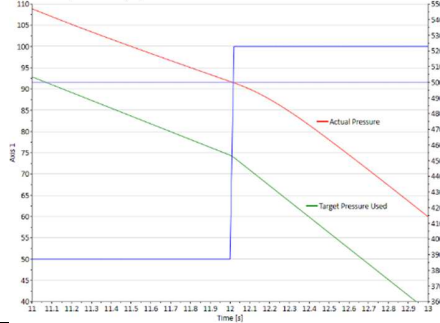

1 Target Pressure Used

Change happens if **Target Pressure Used** reaches the **Threshold**

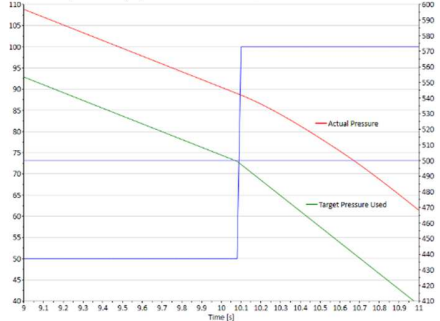

Ramp Type Defines the shape of the ramp

- 0 Linear
- 1 Logarithmic
- 2 Exponential

Actual Slope Used slope as the pressure difference per second (mBar*/sec).

Controller Selector Bitmap Determines which Controller uses the profile ramp. When a controller is selected, the pressure ramp is no longer used in the controller itself. Therefore the ramp is greyed out in the CPA.

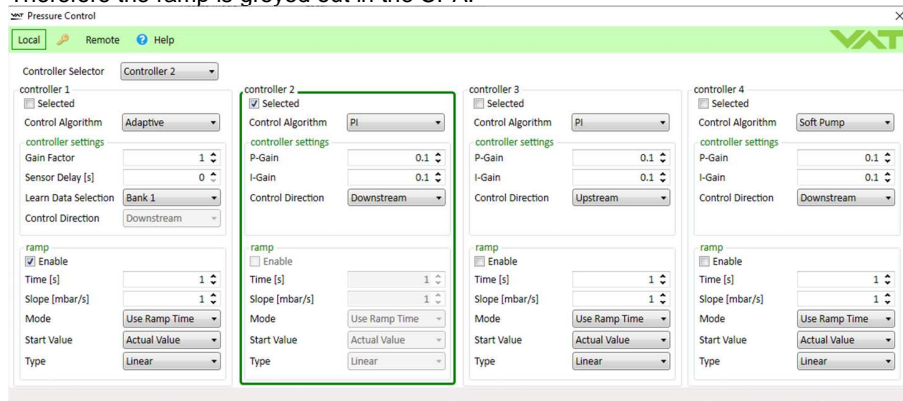

Segment Selector Bitmap Defines which segment is used for the Profile Ramp.

Segment x Threshold This is the upper limit of the segment. The lower limit is defined by the next lower **Threshold**, or the lower limit is 0 if there is no lower **Threshold**.

If the **Target Pressure** is lower than several **Thresholds**, the lowest one is taken.
 If the **Target Pressure** is higher than the highest **Threshold**, the highest one is taken.

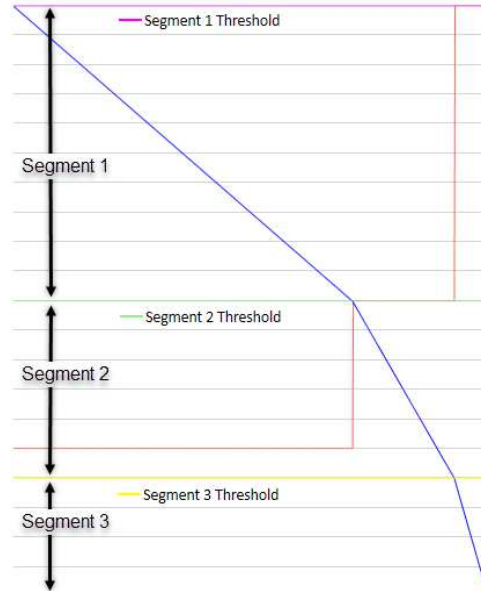

Segment x Slope Defines the slope (pressure/sec) in the segment

* Unit adjustable

Location:
 CPA Parameters EtherCAT Object
 Pressure Control.General Settings.Profile Ramp 2334

4.10.9 Pressure Control Speed

This parameter effects the speed of the valve plate.

Adjustment range is from 0.001 to 0.333
 Default value is 0.333 (= maximum for pressure control)

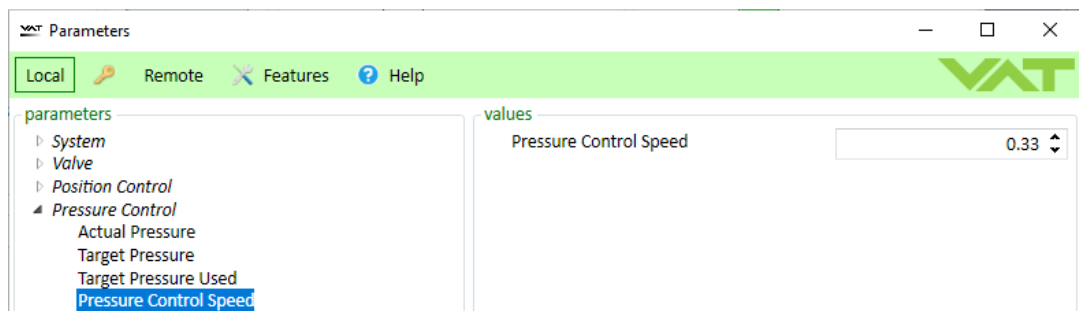

Location:
 CPA Parameters EtherCAT Objects
 Pressure Control.Pressure Control Speed 2300:04

4.11 Position Control

The position controller has 2 parameters that can be adjusted:

- Position Control Speed
- Position Ramp

4.11.1 Position Control Speed

This parameter effects the speed of the valve plate.

Adjustment range is from 0.001 to 0.333

Default value is 0.333 (= maximum for position control)

OPEN and CLOSE are always done with maximum speed (1.000).

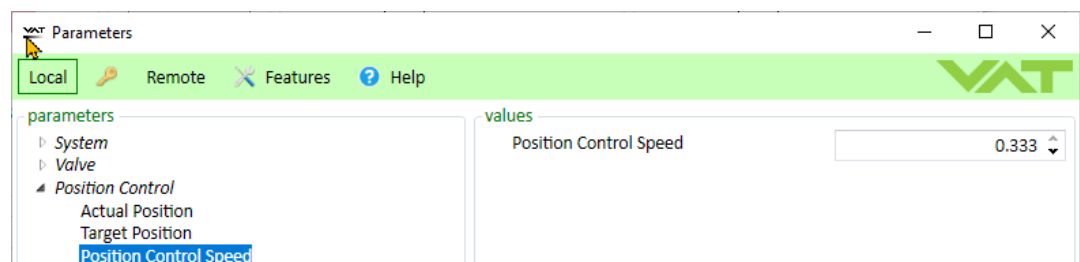

Location:

CPA Parameters EtherCAT Objects
Position Control.Position Control Speed **2200:03**

4.11.2 Position Ramp



Configuration

Parameter	Description
Enable	Activate / Deactivate position ramp
Mode	0:Use Ramp Time 1:Use Ramp Slope See description below
Time	Target reach time in seconds (Used if Mode = 0)
Slope	Limit the rate of position change per second (Used if Mode = 1)
Type	0:Linear 1:Logarithmic 2:Exponential

CPA Parameters EtherCAT Objects
Position Control.Ramp **2126**

4.11.2.1 Mode

Time

Unit: seconds

Time is constant, slope varies

Example: 2 sec

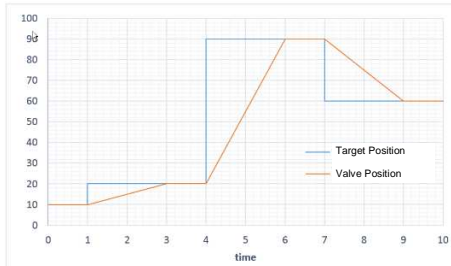

Slope

Unit: %* / seconds

Slope is constant, time varies

Example: 10% / sec

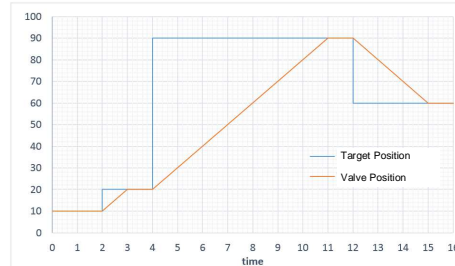

* Unit adjustable

4.11.2.2 Type

Linear

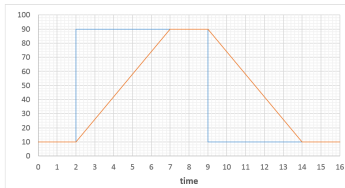

Logarithmic

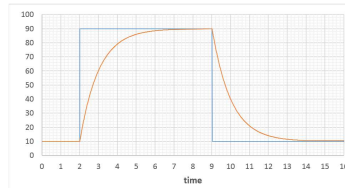

Exponential

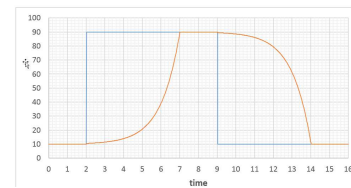

4.12 EtherCAT interface



Neither valve display information nor CONTROL MODE values or any other fieldbus cyclic/acyclic data are related to any fieldbus states/notation

4.12.1 Connection

The EtherCAT interface is galvanic isolated from control unit.

4.12.1.1 Installation (example)

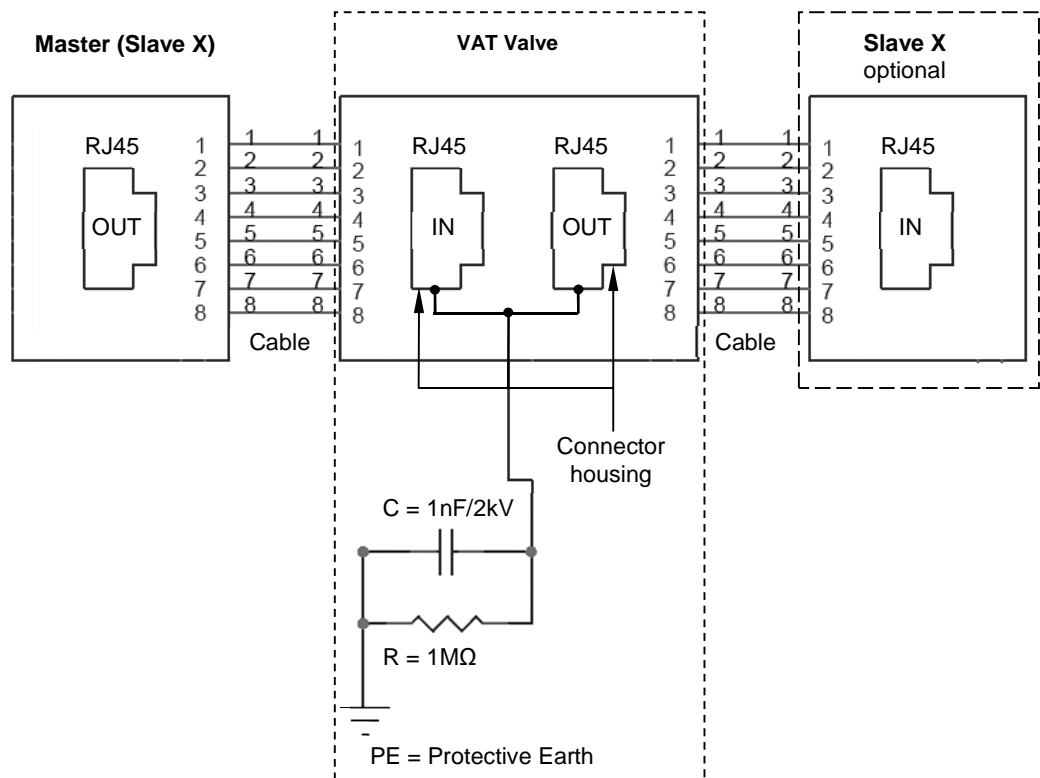

4.12.1.2 Network and cable

- **Connector type: RJ45 standard connector**
- **Cable: CAT5, 6 or 7 STP (shielded twisted pair), not crossover**



Cable length between Master and Slaves max. 100 m.

For all detail information about EtherCAT refer to EtherCAT homepage:
<http://www.ethercat.org>

4.12.2 Device identification, Rotary switches

The Device Identification value (ID) is set by three hexadecimal rotary switches. That means the supported address range is 0-0xFFFF in hexadecimal or 0-4095 in decimal.



The Device Identification value is read once after power on.

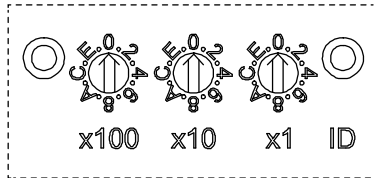

Example: 0

4.12.3 LEDs

- ① RUN LED^{a)}
- ② Error LED^{a)}
- ③ EtherCAT (port 1) IN
- ④ EtherCAT (port 2) OUT
- ⑤ Link/Activity (port 1) IN
- ⑥ Link/Activity (port 2) OUT

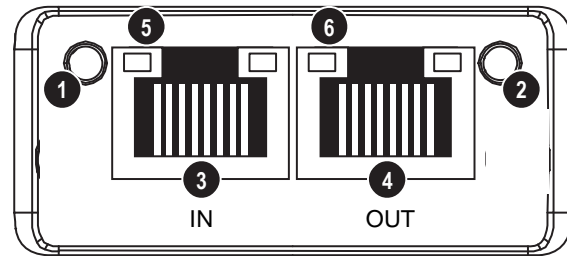

a) The flash sequences for these LEDs are defined in DR303-3 (CiA)

4.12.3.1 Run LED (1)

This LED reflects the status of the CoE (CANopen over EtherCAT) communication.

LED State	Indication	Description
Off	INIT	Device in 'INIT'-state (or no power)
Green	OPERATIONAL	Device in 'OPERATIONAL'-state
Green, blinking	PRE-OPERATIONAL	Device in 'PRE-OPERATIONAL'-state
Green, single flash	SAFE-OPERATIONAL	Device in 'SAFE-OPERATIONAL'-state
Red ^{a)}	EXCEPTON state (Fatal Event)	-

a) If RUN and ERR turns red, this indicates a fatal event, forcing the bus interface to a physically passive state.

4.12.3.2 Error LED (2)

This LED indicates EtherCAT communication errors etc.

LED State	Indication	Description
Off	No error	No error (or no power)
Red, blinking	Invalid configuration	State change received from master is not possible due to invalid register or object settings.
Red, single flash	Unsolicited state change	Slave device application has changed the EtherCAT state autonomously; parameter 'Change' in the AL status register is set to 01h (change/error).
Red, double flash	Application watchdog timeout	Sync manager watchdog timeout
Red ^{a)}	Application controller is not responding any more	EXCEPTION state

a) If RUN and ERR turns red, this indicates a fatal event, forcing the bus interface to a physically passive state.

4.12.3.3 Link/Activity LED's (5 / 6)

These LED's indicate the EtherCAT link status and activity.

LED State	Indication	Description
Off	No link	Link not sensed (or no power)
Green	Link sensed, no activity	Link sensed, no traffic detected
Green flickering	Link sensed, no activity detected	Link sensed, traffic detected

4.12.4 Connection Loss Reaction

Connection Loss reaction defines what the valve is doing in case the EtherCAT connection get lost.

Parameter	Description
Enable	'True' enables the connection loss reaction, in case of 'False' there is no reaction on a connection loss
State	Current connection loss state
Functionality	Defines the functionality in case of connection loss. This can be "open" or "close".

Parameter location:

CPA	EtherCAT Objects
Interface EtherCAT.Connection Loss Reaction	2601:03 2601:04

4.12.5 Position and pressure units

Parameter	Description
Position Unit	1,10,90, 100,1000,10000, user specific
Pressure Unit	
Digital Sensor 1 Input.Pressure Unit ¹⁾	Pa, kPa, bar, mbar, Torr, mTorr, psi, user specific
Digital Sensor 2 Input.Pressure Unit ¹⁾	

¹⁾ Only used for EtherCat sensors

Parameter Location:

CPA	EtherCAT Objects
2610	

Note: The scalers for "Digital Sensor Inputs" are only visible if the sensor source is configured as 'digital'. See chapter «Sensor configuration».

4.12.6 Communication failure

Failure detection with CPA	Action
Network failure: No EtherCAT communication is active	<ul style="list-style-type: none">- Check EtherCAT cable.- Check the EtherCAT connection to master.- Check the process data output watchdog – SyncManager2 settings (see chapter: «EtherCAT configuration - 5. EtherCAT process data output watchdog – SyncManager»).



If you need any further information, please contact one of our service centers. You will find the addresses on our website: www.vatvalve.com.

4.12.7 PDO Process data objects – cyclic communication

4.12.7.1 RxPDO Output mappings

The EtherCAT process data mapping is done automatically corresponding to the following list and respectively to the sync manager information.

Mapping object	Mapping content
0x1600	SINT32 Target Pressure SINT32 Target Position SINT32 Pressure Input Digital Sensor 1 SINT32 Pressure Input Digital Sensor 2 SINT8 Control Mode UINT16 General Control Setpoint FLOAT Pressure Ramp Time
0x1601 (default)	FLOAT Target Pressure FLOAT Target Position FLOAT Pressure Input Digital Sensor 1 FLOAT Pressure Input Digital Sensor 2 SINT8 Control Mode UINT16 General Control Setpoint FLOAT Pressure Ramp Time
0x1602	SINT32 Target Pressure SINT32 Target Position SINT32 Pressure Input Digital Sensor 1 SINT32 Pressure Input Digital Sensor 2 SINT8 Control Mode UINT16 General Control Setpoint
0x1603	FLOAT Target Pressure FLOAT Target Position FLOAT Pressure Input Digital Sensor 1 FLOAT Pressure Input Digital Sensor 2 SINT8 Control Mode UINT16 General Control Setpoint
0x1604	SINT32 Target Position SINT8 Control Mode UINT16 General Control Setpoint
0x1605	FLOAT Target Position SINT8 Control Mode UINT16 General Control Setpoint
0x16FF	Configurable mapping object

Name	Byte	Range	Description
TARGET PRESSURE	4	Value in mBar Adjustable ¹⁾	Setpoint value for CONTROL MODE Pressure (5)
TARGET POSITION	4	0..100 Adjustable ¹⁾	Setpoint value for CONTROL MODE Position (2)
PRESSURE INPUT DIGITAL SENSOR 1	4	Value in mBar Adjustable ¹⁾	Pressure from digital sensor (Sensor with EtherCAT Interface)
PRESSURE INPUT DIGITAL SENSOR 2	4	Value in mBar Adjustable ¹⁾	Pressure from digital sensor (Sensor with EtherCAT Interface)
CONTROL MODE	1	2...7	1 = Homing 2 = Position control 3 = Close 4 = Open 5 = Pressure control 6 = Hold 7 = Learn
GENERAL CONTROL SETPOINT	2	-	See bitmap table below
PRESSURE RAMP TIME	1	0...10E6	Time in ms

1) To adjust range refer to chapter: «EtherCAT scaling»



GENERAL CONTROL SETPOINT bitmap table:

Bit		Description												
0	ZERO ADJUST	Starts the zeroing of the sensors												
1	NOT USED (reserved)	-												
2	PING PONG TX BIT	Handshake mechanism Valve sends the inverted value of this bit in INPUT BUFFER → GENERAL STATUS → PING PONG RX BIT												
3	NOT USED (reserved)	-												
4	ACCESS MODE LOCKED	Defines which interface, remote (EtherCAT) or service (CPA), can control the valve.												
		<table border="1"> <thead> <tr> <th>Access Mode</th> <th>Control Permission</th> <th>Comment</th> </tr> </thead> <tbody> <tr> <td>Local</td> <td>CPA</td> <td></td> </tr> <tr> <td>Remote</td> <td>EtherCAT Master</td> <td>CPA can switch to Local</td> </tr> <tr> <td>Locked</td> <td>EtherCAT Master</td> <td>CPA can't switch to Local</td> </tr> </tbody> </table>	Access Mode	Control Permission	Comment	Local	CPA		Remote	EtherCAT Master	CPA can switch to Local	Locked	EtherCAT Master	CPA can't switch to Local
		Access Mode	Control Permission	Comment										
		Local	CPA											
Remote	EtherCAT Master	CPA can switch to Local												
Locked	EtherCAT Master	CPA can't switch to Local												
If bit is set to 1 than the Access Mode = Locked It bit changes from 1 to 0 than the Access Mode changes to Remote Whether CPA has switched the Access Mode to Local can be seen in the Input Buffer: GENERAL STATUS → ACCESS MODE EXTENDED WARNING → REMOTE CONTROL NOT POSSIBLE														
Overview: <table border="1"> <thead> <tr> <th>From</th> <th>To</th> <th>ACCESS MODE LOCKED bit</th> </tr> </thead> <tbody> <tr> <td>local or remote</td> <td>locked</td> <td>0 → 1</td> </tr> <tr> <td>locked</td> <td>remote</td> <td>1 → 0</td> </tr> <tr> <td>local</td> <td>remote</td> <td>0 → 1 → 0</td> </tr> </tbody> </table>	From	To	ACCESS MODE LOCKED bit	local or remote	locked	0 → 1	locked	remote	1 → 0	local	remote	0 → 1 → 0		
From	To	ACCESS MODE LOCKED bit												
local or remote	locked	0 → 1												
locked	remote	1 → 0												
local	remote	0 → 1 → 0												
5-15	NOT USED (reserved)	-												

4.12.7.2 TxPDO Input mappings

The EtherCAT process data mapping is done automatically corresponding to the following list and respectively to the sync manager information.

Mapping object	Mapping content	Name	Byte	Range	Description
0x1A00	SINT32	Actual Pressure	4	Value in mBar adjustable ¹⁾	ACTUAL PRESSURE
	SINT32	Pressure Sensor 1			
	SINT32	Pressure Sensor 2	4	Value in mBar adjustable ¹⁾	PRESSURE SENSOR 1
	SINT32	Actual Position			
	SINT8	Control Mode	4	Value in mBar adjustable ¹⁾	PRESSURE SENSOR 2
	UINT16	Error Number			
	UINT16	General Status			
	UINT16	General Warnings			
UINT32	Extended Warnings				
0x1A01 <i>(default)</i>	FLOAT	Actual Pressure	4	0...100 adjustable ¹⁾	ACTUAL POSITION
	FLOAT	Pressure Sensor 1			
	FLOAT	Pressure Sensor 2	1	0...14	CONTROL MODE
	FLOAT	Actual Position			
	SINT8	Control Mode			
	UINT16	Error Number			
	UINT16	General Status			
	UINT16	General Warnings			
UINT16	General Warnings				
UINT32	Extended Warnings				
0x1A02	SINT32	Actual Position	2	200...888	ERROR NUMBER
	SINT8	Control Mode			
	UINT16	Error Number			
	UINT16	General Status			
	UINT16	General Warnings			
0x1A03	FLOAT	Actual Position	2		GENERAL STATUS
	SINT8	Control Mode			
	UINT16	Error Number			
	UINT16	General Status			
	UINT16	General Warnings			
0x1AFF	UINT32	Extended Warnings	2		GENERAL WARNING
	Configurable mapping object				

¹⁾ To adjust range refer to chapter: «Scaling of pressure and position values»

GENERAL STATUS bitmap table:

Bit	Description												
0	FIELD BUS DATA VALID 0 = Valve is not in the EtherCAT state OPERATIONAL or the process data output watchdog (SyncManager2) is disabled 1 = Valve is in the EtherCAT state OPERATIONAL and the process data output watchdog (SyncManager2) is enabled												
1	ZERO ADJUST EXECUTED ZERO ADJUST successful executed, active for 2 seconds												
2	PING PONG RX-BIT Handshake mechanism Is the inverted PING PONG TX-BIT from OUTPUTBUFFER → GENERAL CONTROL SETPOINT												
3	PRESSURE SIMULATION 1 = Internal pressure simulation active												
4	TARGET PRESSURE REACHED 1 = The actual pressure is within 2% of the pressure setpoint												
5-6	NOT USED (reserved) -												
7-8	ACCESS MODE <table border="0"> <tr> <td>bit 8</td> <td>bit 7</td> <td></td> </tr> <tr> <td>0</td> <td>0</td> <td>= LOCAL</td> </tr> <tr> <td>0</td> <td>1</td> <td>= REMOTE</td> </tr> <tr> <td>1</td> <td>0</td> <td>= LOCKED</td> </tr> </table>	bit 8	bit 7		0	0	= LOCAL	0	1	= REMOTE	1	0	= LOCKED
bit 8	bit 7												
0	0	= LOCAL											
0	1	= REMOTE											
1	0	= LOCKED											
9	WARNINGS ACTIVE 1 = At least one WARNING of the warning bitmaps is active (GENERAL WARNING bitmap and EXTENDED WARNING bitmap)												
10	SEALING STATE 1 = valve is sealed, only valid if a sealing functionality is available												
11	INTERLOCK ACTIVE 1 = an interlock input is active												
12-15	NOT USED (reserved) -												

GENERAL WARNING bitmap table:

Bit	Description
0	NOT USED (reserved) -
1	LEARN DATA SET Learn data not present. Learn required for adaptive pressure control. Just active if adaptive pressure control algorithm is chosen.
2	NOT USED (reserved) -
3	POWER FAILURE BATTERY Not ready, voltage too low. Just active if power failure is available.
4-5	NOT USED (reserved) -
6	FAN STALL ALARM Just available when fan provides a stall alarm
7-15	NOT USED (reserved) -

EXTENDED WARNING bitmap table:

Bit		Description
0	REMOTE CONTROL NOT POSSIBLE	Remote control not possible, access mode local is active, change to access mode remote or access mode locked
1	ACTUAL CONTROL MODE SETPOINT NOT ALLOWED	Not possible to switch the actual control mode to CONTROL MODE SETPOINT <ul style="list-style-type: none"> • Control mode is interlock or fatal error • CONTROL MODE SETPOINT is 5 (pressure) or 7 (learn) and no sensor is selected (sensor mode configuration)
2	ZERO DISABLED	Using zero function not possible
3	PFO DEACTIVATED	Power Failure Option is deactivated
4	NOT USED (reserved)	-
5	OUT OF RANGE: PRESSURE SETPOINT	Value of PRESSURE SETPOINT is out of range
6	OUT OF RANGE: POSITION SETPOINT	Value of POSITION SETPOINT is out of range
7-9	NOT USED (reserved)	-
10	OUT OF RANGE: CONTROL MODE SETPOINT	Value of CONTROL MODE SETPOINT is out of range
11	OUT OF RANGE: GENERAL CONTROL SETPOINT	Value of GENERAL CONTROL SETPOINT is out of range
12-15	NOT USED (reserved)	-

4.12.7.3 Ping Pong

With the Ping pong mechanism the master can verify that the slave has read the PDO buffer content sent by the master.

Principle:

Master sets the Ping pong bit in the object "General Control Setpoint". When the slave receives the value of "General Control Setpoint", the slave will invert this Ping pong bit and put it into ping pong of "General Status"

Example:

The master wants to have a confirmation that the slave has received a new value of "Target Position":

1. Master sets "Target Position" to 123 and set Ping pong bit of "General Control Setpoint" to 0
2. Master waits till Ping pong bit of "General Status" has changed to 1 → This is the confirmation, that the PDO telegram with the new "Target Position" was received by the slave

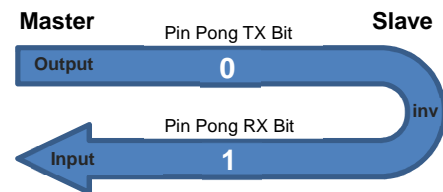

4.12.8 SDO Service data objects – acyclic communication

VAT uses for acyclic parameter data handling a standard EtherCAT mailbox transfer. The mailbox protocol is CoE (CANopen over EtherCAT), compliant to DS301 (CiA Draft Standard 301 v4.02).

4.12.8.1 List of abbreviations:

RO	Read Only
RW	Read Write
NV	Non-Volatile
V	Volatile
SI	Sub Index
Acc	Access

4.12.8.2 Standard Object Entries

Index	SI	Name	Data Type	Acc	NV	Unit	Min	Max	Description
1000		Device Type	UINT32	RO					0000 0000h (No profile)
1008		Manufacturer Device Name	Visible String	RO					
1009		Manufacturer Hardware Version	Visible String	RO					x.y.z
100A		Manufacturer Software Version	Visible String	RO					w.x.y.z w = Valve Firmware Version x = Valve Firmware Revision y = EtherCAT Stack Firmware z = Drive Firmware(s) w Format = aabcc a = Generation b = Type Customer Basis Production c = Revision Example: 0C15 Generation 01 Customer Version 15
100B		Manufacturer Bootloader Version	Visible String	RO					
1018		Identity Object	UINT8	RO					
	1	Vendor Id	UINT32	RO					0x0549 for VAT Vakuumentile AG
	2	Product Code	UINT32	RO					
	3	Revision Number	UINT32	RO					
	4	Serial Number	UINT32	RO					
1600		RxPDO Mapping Outputs Integer 1	UINT8	RO					See ESI file for content
1601		RxPDO Mapping Outputs Float 1	UINT8	RO					See ESI file for content
1602		RxPDO Mapping Outputs Integer 2	UINT8	RO					See ESI file for content
1603		RxPDO Mapping Outputs Float 2	UINT8	RO					See ESI file for content
1604		RxPDO Mapping Outputs Integer 3	UINT8	RO					See ESI file for content
1605		RxPDO Mapping Outputs Float 3	UINT8	RO					See ESI file for content
16FF		RxPDO Mapping Outputs User	UINT8	RO					User mapping

Index	SI Name	Data Type	Acc	NV	Unit	Min	Max	Description
1A00	<i>TxPDO Mapping Inputs Integer 1</i>	UINT8	RO					See ESI file for content
1A01	<i>TxPDO Mapping Inputs Float 1</i>	UINT8	RO					See ESI file for content
1A02	<i>TxPDO Mapping Inputs Integer 2</i>	UINT8	RO					See ESI file for content
1A03	<i>TxPDO Mapping Inputs Float 2</i>	UINT8	RO					See ESI file for content
1AFF	<i>TxPDO Mapping Inputs User</i>	UINT8	RO					User mapping
1C00	<i>Sync Manager Communication Type</i>	UINT8	RO					
	1 <i>CommunicationTypeSyncManager0</i>	UINT8	RO					
	2 <i>CommunicationTypeSyncManager1</i>	UINT8	RO					
	3 <i>CommunicationTypeSyncManager2</i>	UINT8	RO					
	4 <i>CommunicationTypeSyncManager3</i>	UINT8	RO					
1C10	<i>Sync Manager 0 PDO Assignment</i>	UINT8	RO					
1C11	<i>Sync Manager 1 PDO Assignment</i>	UINT8	RO					
1C12	<i>Sync Manager 2 PDO Assignment</i>	UINT8	RW					
	1 <i>Sub Index 001</i>	UINT16	RW					
1C13	<i>Sync Manager 3 PDO Assignment</i>	UINT8	RW					
	1 <i>Sub Index 001</i>	UINT16	RW					
1C32	<i>Sync Manager 2 Synchronization</i>	UINT8	RO					
	1 <i>Synchronization Type</i>	UINT16	RO					
	2 <i>Cycle Time</i>	UINT32	RO					
	4 <i>Synchronization Types Supported</i>	UINT16	RO					
1C33	<i>Sync Manager 3 Synchronization</i>	UINT8	RO					
	1 <i>Synchronization Type</i>	UINT16	RO					
	2 <i>Cycle Time</i>	UINT32	RO					
	4 <i>Synchronization Types Supported</i>	UINT16	RO					
	20 <i>Sync Error</i>	BOOL	R					

4.12.8.3 Manufacturer specific object entries

Index	SI Name	Data Type	Acc	Mapping	NV	Unit	Min	Max	Def	Description
2002	Control Mode	SINT8	RW	TX/RX	V		0	14		0: Init 1: Homing 2: Position 3: Close 4: Open 5: Pressure Control 6: Hold 7: Learn 8: Interlock Open 9: Interlock Close 12: Power Failure 13: Safety 14: Error
200B	Access Mode	SINT8	RW	TX	V		0	2		0: Local 1: Remote 2: Remote Locked
2010	Identification	REC								
1	Serial Number	STRING	RO		NV					
2	Valve Series	UINT16	RO		NV		0	980		Example 655: Series 65.5
3	Valve Variant	UINT16	RO		NV		0	100		0: Standard 1: Differential Plate 2: Face Seal 3: Aluminium 4: Stainless Steel 5: Single Drive 6: Compact 7: Fast 8: Sync 9: Direct Drive 100: Toblerone
4	Nominal Diameter	UINT16	RO		NV		20	62		20: DN10 24: DN16 28: DN25 32: DN40 34: DN50 36: DN63 38: DN80 39: DN88 40: DN100 44: DN160 46: DN200 48: DN250 50: DN320 51: DN350 52: DN400 54: DN500 56: DN630 58: DN800 60: DN1000 62: DN1250
8	Controller Type	UINT16	RO		NV		1	5		1: IC2H1 2: IC2H2 3: IC2H3 4: IC2H4 5: IC2H5 6: IC2H6 7: IC2H7
9	Interface Type	UINT16	RO		NV		1	5		1: RS232/RS485 2: EtherCAT 3: DeviceNET 4: Onboard 5: Logic
A	Option Type	UINT16	RO		NV		0	11		0: Not Available 1: SPS 2: PFO 3: Cluster 4: SPS + PFO 5: SPS + Cluster 6: PFO + Cluster 7: SPS + PFO + Cluster
C	Configuration Parameters ID	STRING	RO		NV					
D	Drive Parameters ID	STRING	RO		NV					
E	Firmware ID	STRING	RO		V					
F	Firmware Version	STRING	RO		V					
10	CPA Version	STRING	RO		V					
11	Interface Firmware Version	STRING	RO		V					
12	Motion Controller 1 Firmware Version	STRING	RO		V					
13	Motion Controller 2 Firmware Version	STRING	RO		V					



Index	SI Name	Data Type	Acc	Mapping	NV	Unit	Min	Max	Def	Description
2020	Statistics	REC								
1	Start Up Counter	UINT32	RO	TX	NV				0	
2	Total Time Powered	UINT32	RO	TX	NV	sec			0	Stored every 15 minutes
3	Time Since Power On	UINT32	RO	TX	NV	sec			0	
2030	Warning/Error	REC								
1	Warning Bitmap	UINT32	RO	TX	V					Bit Hex Description 0 1 No Learn Data 2 4 No Sensor Active 3 8 PFO Not Ready 6 40 Fieldbus Data Not Valid
2	Error Bitmap	UINT32	RO	TX	V					Bit Hex Description 0 1 Homing Position Error 1 2 Homing Not Running 2 4 Homing Error State 3 8 Operation Position Error 4 10 Operation Not Running 5 20 Operation Error State 12 1000 Other Component 30 40000000 General 31 80000000 Internal
3	Error Number	UINT16	RO	TX	V					See relevant chapter
4	Error Code	UINT16	RO	TX	V					See relevant chapter
2050	Services	REC								
1	Restart Controller	BOOL	RW		V					Set to 1 to start the service
2	Store User Parameters	BOOL	RW		V					
3	Restore User Parameters	BOOL	RW		V					
5	Restore Factory Parameters	BOOL	RW		V					
6	Configuration Lock Mode	BOOL	RW		NV				0	Protection of settings. If active the valve does not accept set commands for parameters that are stored in non-volatile memory. 0: not locked 1: locked
7	Internal Services	UINT32	RW		V					
2111	Isolation State	BOOL	RO	TX	NV		0	1		0: Not Isolated 1: Isolated
2112	Position State	UINT8	RO	TX	V		0	2		Indication of valve position 0: Intermediate 1: Closed 2: Open
2120	Homing	REC								
1	Start Condition	UINT8	RW		NV		0	5	0	0: Standard Do homing after restart if valve is not in isolated state 1: Open Command, Do homing on an open command 2: Move Command, Do homing on any move command 3: At Startup, Do homing after restart 4: Homing Command, Do homing on homing command 5: Move Command Without Close Settings from move commands, without homing in close position by close command

Index	SI Name	Data Type	Acc	Mapping	NV	Unit	Min	Max	Def	Description
2	Mode	UINT8	RW		NV		0	1	0	Not supported yet
3	End Control Mode	SINT8	RW		NV		2	5	2	Control Mode after homing 2:Position 3:Close 4:Open 5:Pressure Control
4	End Position	FLOAT	RW		NV	pos*	0.0*	100.0*	0.0	Position after homing if End Control Mode is 2 (Position)
5	Status	SINT16	RO	TX	V		0	3		0:Not Started 1:In Progress 2:Completed Successfully 3>Error Occurred
2121	Position Restriction	REC								Position restriction of the valve movement.
1	Enable	BOOL	RW	TX/RX	NV		0	1	0	
3	Maximum Control Position	FLOAT	RW	TX/RX	NV	pos*	0.0*	100.0*	100.0*	With an enabled Position Restriction the valve will not move above this position
4	Restriction Active	BOOL	RO	TX/RX	V		0	1		Indicates if currently a position restriction is active
2126	Position Ramp	REC								
1	Enable	BOOL	RW		NV		0	1	0	Activate/Deactivate position target ramp.
2	Time	FLOAT	RW		NV		0	1E+7	0	
3	Slope	FLOAT	RW		NV		0	1E+8	0	
4	Mode	UINT8	RW		NV		0	1	0	0:Use Ramp Time 1:Use Ramp Slope
5	Type	UINT8	RW		NV		0	2	0	0:Linear 1:Logarithmic 2:Exponential
2130	Cycle Counter	REC								
1	Control Cycles	UINT32	RW	TX	NV				0	The valve movement is summarized. The distance open -> close -> open is 1 Control Cycle. This value can be manipulated by the customer.
2	Control Cycles Total	UINT32	RO	TX	NV				0	See Control Cycles. This value is the number of Control Cycles in valve lifespan.
3	Isolation Cycles	UINT32	RW	TX	NV				0	A Isolation Cycle is done if the valve has reached the isolated state. This value can be manipulated by the customer.
4	Isolation Cycles Total	UINT32	RO	TX	NV				0	See Isolation Cycles. This value is the number of Isolation Cycles in valve lifespan.
2160	External Isolation	REC								Only used if an external isolation valve is available
1	Follow Valve	BOOL	RW		NV		0	1	1	0:Isolation valve handled by using Target State object 1:Isolation valve automatically handled by valve. In case the valve gets close the external isolation valve gets close too.
2	Plate Position Isolated	FLOAT	RW		NV	pos*	0.0*	100.0*	25.0*	Only active if Follow Valve is true. Valve position when the Control Mode is set to close. To avoid a hollow space between valve and external isolation valve.
3	Target State	BOOL	RO	TX	V		0	1		If Follow Valve value is 0 than this parameter is settable. 0: Open, external isolation valve will open 1: Close, external isolation valve will close
4	State	BOOL	RO	TX	V		0	1		0: Not Isolated (external isolation valve is not close) 1: Isolated (external isolation valve is close)
5	Indicator Open	BOOL	RO	TX	V		0	1		
6	Indicator Close	BOOL	RO	TX	V		0	1		



Index	SI Name	Data Type	Acc	Mapping	NV	Unit	Min	Max	Def	Description
7	Warning	BOOL	RO	TX	V		0	1	0	Set if external isolation valve is not follows on Target State . Indicator open has not expected state.
8	Isolation Cycles	UINT32	RW	TX	NV					Number of Isolation Cycles (resettable)
9	Isolation Cycles Total	UINT32	RO	TX	NV					Number of Isolation Cycles in valve lifespan.
21C0	Drive Parameter A1	REC								
21D0	Drive Parameter A2	REC								
1	Maximal Speed	FLOAT	RW		NV	r/s	0	100	***	
2	Maximal Acceleration	FLOAT	RW		NV	r/s2	0	1000	***	
3	Maximal Deceleration	FLOAT	RW		NV	r/s2	0	1000	***	
4	Jerk Limit	FLOAT	RW		NV	r/s3	0	10000	***	Value 0 means not jerk limitation
5	Home Offset	FLOAT	RW		NV	r	-100	100	***	
6	Range of Movement	FLOAT	RW		NV	r	0	10000	***	
7	Axis Only Movement Position	FLOAT	RW		NV	Range of Movement	0	1	***	S65.5 only
8	Maximum Current	FLOAT	RW		NV	Ampere	0	8	***	
9	Isolation Current	FLOAT	RW		NV	Ampere	0	8	***	
A	Drive Backlash	FLOAT	RW		NV	r	0	0.01		Drive Parameter A2 only, S65.5 only
32	Iq	FLOAT	RO	TX		Ampere				Torque producing current, vector of the two phase currents
FE	Enable Backlash Sine Subtraction	BOOL	RW		NV	r	0	1		Drive Parameter A2 only, S65.5 only
2200	Position Control	REC								
1	Actual Position	FLOAT	RO	TX	V	pos*	0.0*	100.0*		
2	Target Position	FLOAT	RW	TX/RX	V	pos*	0.0*	100.0*		
3	Position Control Speed	FLOAT	RW	TX/RX	NV		0.001	1.0	1.0	Speed valid in Control Mode = Position, 0.33 equals full speed
2300	Pressure Control	REC								
1	Actual Pressure	FLOAT	RO	TX	V	mbar*				
2	Target Pressure	FLOAT	RW	TX/RX	V	mbar*	0.0	SFS		
3	Target Pressure Used	FLOAT	RO	TX	V	mbar*	0.0	SFS		This value is set as pressure controller input. It differs to the Target Pressure if a pressure ramp (see object 2311-2314) is used.
4	Pressure Control Speed	FLOAT	RW	TX/RX	NV		0.001	1.0	1.0	Speed valid in Control Mode = Pressure, 0.33 equals full speed
2310	Pressure Controller Selector	UINT8	RW	TX/RX	NV		1	4	1	Active Controller in Control Mode = Pressure 1:Controller 1 2:Controller 2 3:Controller 3 4:Controller 4
2311	Pressure Controller 1	REC								
2312	Pressure Controller 2	REC								
2313	Pressure Controller 3	REC								
2314	Pressure Controller 4	REC								
1	Control Algorithm	UINT8	RW	TX/RX	NV		0	2	**	0:Adaptive 1:PI 2:Soft Pump ** Controller 1 = 0, Controller 2 and 3 = 2, Controller 4 = 3
2	P-Gain	FLOAT	RW	TX/RX	NV		0.001	100.0	0.1	Used for Control Algorithm PI and Soft Pump

Index	SI Name	Data Type	Acc	Mapping	NV	Unit	Min	Max	Def	Description
3	I-Gain	FLOAT	RW	TX/RX	NV **		0.	100.0	0.1	Used for Control Algorithm PI and Soft Pump
4	Gain Factor	FLOAT	RW	TX/RX	NV **		0.0001	100.0	1.0	Used for Control Algorithm Adaptive
5	Sensor Delay	FLOAT	RW	TX/RX	NV **	sec	0.0	1.0	0.0	Used for Control Algorithm Adaptive
6	Learn Data Selection	UINT8	RW	TX/RX	NV **		0	3	0	Used for Control Algorithm Adaptive 0:Bank 1 1:Bank 2 2:Bank 3 3:Bank 4
7	Control Direction	UINT8	RW	TX/RX	NV **		0	1	**	Used for Control Algorithm PI and Soft Pump 0:Downstream 1:Upstream ** Controller 1,2 and 4 = 0, Controller 3 = 1
8	Position Filter Time	FLOAT	RW	TX/RX	NV **	sec	0	10	0.0	(advanced optimization)
A	Ramp Enable	BOOL	RW	TX/RX	NV **		0	1	1	Activate/Deactivate pressure target ramp. The effective target pressure can be read in Object 2300:03 Target Pressure Used
B	Ramp Time	FLOAT	RW	TX/RX	NV **	sec	0.0	1000000.0	1.0	Target reach time
C	Ramp Slope	FLOAT	RW	TX/RX	NV **	mbar*/sec	0.0	SFS	1.333224	Limit the rate of pressure change
D	Ramp Mode	UINT8	RW	TX/RX	NV **		0	1	0	0:Use Ramp Time 1:Use Ramp Slope
E	Ramp Start Value	UINT8	RW	TX/RX	NV **		0	1	1	0:Previous Ramp Value 1:Actual Pressure Value
F	Ramp Type	UINT8	RW	TX/RX	NV **		0	2	0	0:Linear 1:Logarithmic 2:Exponential Not supported yet
14	P-Gain Limit	FLOAT	RW	TX/RX	NV **		0	1000	0.0	Used for Control Algorithm Adaptive (advanced optimization)
15	Flow Factor Filter Time	FLOAT	RW	TX/RX	NV **		0	10	0.4	Used for Control Algorithm Adaptive (advanced optimization)
16	Flow Factor Filter Order	UINT8	RW	TX/RX	NV **		1	6	2	Used for Control Algorithm Adaptive (advanced optimization)
2330	Store Control Parameter Volatile	BOOL	RW		NV		0	1	0	0:Store in NV Memory 1:Do Not Store in NV Memory
2331	Pressure Control Position Restriction	REC								Limit the valve movement in Control Mode Pressure
1	Enable	BOOL	RW	TX/RX	NV		0	1	0	
2	Minimum Control Position	FLOAT	RW	TX/RX	NV	pos*	0.0*	100.0*	0.0*	
3	Maximum Control Position	FLOAT	RW	TX/RX	NV	pos*	0.0*	100.0*	100.0*	
2333	Automated Controller Selector	REC								
1	Enable	BOOL	RW	TX/RX	NV		0	1	0	



Index	SI Name	Data Type	Acc	Mapping	NV	Unit	Min	Max	Def	Description
2	Mode	UINT8	RW	TX/RX	NV		0	1	0	Defines how the Controller is selected 0: Threshold 1: Pressure Direction
3	Controller Selector Bitmap	UINT8	RW	TX/RX	NV		0	15	15	Used if Mode = 0 Threshold Determines which controller/threshold will participate in the automated selection
4	Controller 1 Threshold	FLOAT	RW	TX/RX	NV	mbar*	0.0	1000	0	Used if Mode = 0 Threshold Upper pressure limit for Controller 1 selection
5	Controller 2 Threshold	FLOAT	RW	TX/RX	NV	mbar*	0.0	1000	0	Used if Mode = 0 Threshold Upper pressure limit for Controller 2 selection
6	Controller 3 Threshold	FLOAT	RW	TX/RX	NV	mbar*	0.0	1000	0	Used if Mode = 0 Threshold Upper pressure limit for Controller 3 selection
7	Controller 4 Threshold	FLOAT	RW	TX/RX	NV	mbar*	0.0	1000	0	Used if Mode = 0 Threshold Upper pressure limit for Controller 4 selection
8	Threshold Condition	UINT8	RW	TX/RX	NV		0	0	0	Used if Mode = 0 Threshold 0: Lower or equal 1: Equal
9	Controller Pressure Rising	UINT8	RW	TX/RX	NV		0	3	0	Used if Mode = 1 Pressure Direction Select Controller which is use for up control 0: Controller 1 1: Controller 2 2: Controller 3 3: Controller 4
A	Controller Pressure Falling	UINT8	RW	TX/RX	NV		0	3	0	Used if Mode = 1 Pressure Direction Select Controller which is use for down control 0: Controller 1 1: Controller 2 2: Controller 3 3: Controller 4
2334	Profile Ramp	REC								Defines pressure depending target pressure ramp (soft pump, soft vent curve)
1	Enable	BOOL	RW	TX/RX	NV		0	1	0	
2	Threshold Mode	UINT8	RW	TX/RX	NV		0	1	0	Defines which pressure the threshold refers to 0: Actual Pressure 1: Target Pressure Used
3	Ramp Type	UINT8	RW	TX/RX	NV		0	2	0	0: Linear 1: Logarithmic 2: Exponential
4	Actual Slope	FLOAT	RO	RX	V	mbar*/sec	0.0	1000000.0	0	
5	Segment Selector Bitmap	UINT16	RW	TX/RX	NV		0	1023	0	Defines which segment is used for the Profile Ramp
6	Controller Selector Bitmap	UINT8	RW	TX/RX	NV		0	15	0	Determines which Controller 2311,2312,2313,2314 uses the profile ramp
7	Segment 1 Threshold	FLOAT	RW	TX/RX	NV	mbar*	0.0	1000000.0	0	Upper pressure limit of pressure segment 1
8	Segment 1 Slope	FLOAT	RW	TX/RX	NV	mbar*/sec	0.0	1000000.0	0	Ramp slope in the segment 1
9	Segment 2 Threshold	FLOAT	RW	TX/RX	NV	mbar*	0.0	1000000.0	0	Upper pressure limit of pressure segment 2
A	Segment 2 Slope	FLOAT	RW	TX/RX	NV	mbar*/sec	0.0	1000000.0	0	Ramp slope in the segment 2
B	Segment 3 Threshold	FLOAT	RW	TX/RX	NV	mbar*	0.0	1000000.0	0	Upper pressure limit of pressure segment 3
C	Segment 3 Slope	FLOAT	RW	TX/RX	NV	mbar*/sec	0.0	1000000.0	0	Ramp slope in the segment 3
D	Segment 4 Threshold	FLOAT	RW	TX/RX	NV	mbar*	0.0	1000000.0	0	Upper pressure limit of pressure segment 4
E	Segment 4 Slope	FLOAT	RW	TX/RX	NV	mbar*/sec	0.0	1000000.0	0	Ramp slope in the segment 4
F	Segment 5 Threshold	FLOAT	RW	TX/RX	NV	mbar*	0.0	1000000.0	0	Upper pressure limit of pressure segment 5
10	Segment 5 Slope	FLOAT	RW	TX/RX	NV	mbar*/sec	0.0	1000000.0	0	Ramp slope in the segment 5
11	Segment 6 Threshold	FLOAT	RW	TX/RX	NV	mbar*	0.0	1000000.0	0	Upper pressure limit of pressure segment 6

Index	SI Name	Data Type	Acc	Mapping	NV	Unit	Min	Max	Def	Description
12	Segment 6 Slope	FLOAT	RW	TX/RX	NV	mbar*/sec	0.0	1000000.0	0	Ramp slope in the segment 6
13	Segment 7 Threshold	FLOAT	RW	TX/RX	NV	mbar*	0.0	1000000.0	0	Upper pressure limit of pressure segment 7
14	Segment 7 Slope	FLOAT	RW	TX/RX	NV	mbar*/sec	0.0	1000000.0	0	Ramp slope in the segment 7
15	Segment 8 Threshold	FLOAT	RW	TX/RX	NV	mbar*	0.0	1000000.0	0	Upper pressure limit of pressure segment 8
16	Segment 8 Slope	FLOAT	RW	TX/RX	NV	mbar*/sec	0.0	1000000.0	0	Ramp slope in the segment 8
17	Segment 9 Threshold	FLOAT	RW	TX/RX	NV	mbar*	0.0	1000000.0	0	Upper pressure limit of pressure segment 9
18	Segment 9 Slope	FLOAT	RW	TX/RX	NV	mbar*/sec	0.0	1000000.0	0	Ramp slope in the segment 9
19	Segment 10 Threshold	FLOAT	RW	TX/RX	NV	mbar*	0.0	1000000.0	0	Upper pressure limit of pressure segment 10
1A	Segment 10 Slope	FLOAT	RW	TX/RX	NV	mbar*/sec	0.0	1000000.0	0	Ramp slope in the segment 10
2350	Adaptive Learn	REC								
2	Type	SINT8	RW		NV		0	0	0	0:Standard
3	Bank Selection	SINT8	RW		NV		0	3	0	Select a learn bank to save the data for the following learn procedure 0: Bank 1 1: Bank 2 2: Bank 3 3: Bank 4
4	Pressure Limit [SFS]	FLOAT	RW	TX/RX	NV	SFS	0.01	1.2	1.0	Learn procedure will be executed to the Pressure Limit
5	Open Speed	FLOAT	RW		NV		0.001	1.0	1.0	1.0 equals to full speed
6	Status	SINT8	RO	TX	V		0	4		0: Not Started 1: In Progress 2: Completed Successfully 3: Aborted 4: Failed
7	Warning Info	UINT16	RO	TX	V					Bit 0: Learn is running Bit 1: Checksum error (learn data corrupt) Bit 2: Learn procedure terminated by user Bit 3: Pressure at position open > 50% of pressure limit Bit 4: Pressure at minimal conductance position < 10 % of pressure limit Bit 5: Pressure falls while move valve in direction of close Bit 6: Pressure at open position does not match pressure of previous open Bit 7: Learn procedure terminated by program Bit 8: Pressure <= 0 at open position (no gas flow set?)
8	Delete All Learn Bank Data	BOOL	RW		V		0	1		Set to 1 delete all learn bank data.
9	Pressure Limit	FLOAT	RW		NV	mbar*				See Pressure Limit [SFS] above, same functionality but user pressure scaling is used
2351	Adaptive Learn Position Table	ARRAY								
1	Sub Index 1	FLOAT	RW		NV	pos*	0.0	1.0		0.0: minimum position 1.0: open position -1.0: not used element
⋮	⋮									
3C	Sub Index 60									

Index	SI Name	Data Type	Acc	Mapping	NV	Unit	Min	Max	Def	Description
2360	Adaptive Learn Bank 1	REC								
2370	Adaptive Learn Bank 2	REC								
2380	Adaptive Learn Bank 3	REC								
2390	Adaptive Learn Bank 4	REC								
01	Status	SINT8	RO		NV		0	2	0	0:Not used 1:Available 2:Available with Warnings
02	Warning Info	UINT16	RO		NV				0	
03	Type	SINT8	RO		NV		0	0	0	0:Standard
04	Delete Learn Bank Data	BOOL	RW		V					Set to 1 delete learn bank data.
2361	Learn Bank 1 Data	ARRAY								
2371	Learn Bank 2 Data	ARRAY								
2381	Learn Bank 3 Data	ARRAY								
2391	Learn Bank 4 Data	ARRAY								
1	Sub Index 1	UINT32	RW		NV					To copy learn data copy this content to another bank (or valve)
⋮										
7C	Sub Index 124									
2362	Learn Bank 1 Position Table	ARRAY								
2372	Learn Bank 2 Position Table	ARRAY								
2382	Learn Bank 3 Position Table	ARRAY								
2392	Learn Bank 4 Position Table	ARRAY								
1	Sub Index 1	FLOAT	RO		NV	pos*	0.0*	100.0*		
⋮										
3C	Sub Index 60									
2363	Learn Bank 1 Pressure Table									
2373	Learn Bank 2 Pressure Table									
2383	Learn Bank 3 Pressure Table									
2393	Learn Bank 4 Pressure Table									
1	Sub Index 1	FLOAT	RO		NV	mbar*				
⋮										
3C	Sub Index 60									
2400	Sensor Zero Adjust	REC								
1	Sensor Selection	SINT8	RW	TX/RX	V		0	2		0:Sensor 1 + 2 1:Sensor 1 2:Sensor 2
2	Target Pressure	FLOAT	RW	TX/RX	V	mbar*				This value is typically the value 0.0 when the chamber is fully pumped down. But it could also be the value of another pressure.
3	Execute	SINT8	RW	TX/RX	V		1	2		Write to this object to execute a Zero Adjust or clear the Zero Adjust offset value. The calculated offset value can read in Sensor 1 Zero Adjust Offset Value [SFS] or Sensor 2 Zero Adjust Offset Value [SFS]. Be sure that Zero Adjust Enable (Zero Adjust Enable Sensor 1 and Sensor 2) is 1, in other case the executed Zero Adjust has no effect on the Actual Pressure value 1:Execute Zero Adjust 2:Clear Offset Value
2401	Sensor 1	REC								
2402	Sensor 2	REC								

Index	SI Name	Data Type	Acc	Mapping	NV	Unit	Min	Max	Def	Description
1	Available	BOOL	RW		NV		0	1	1	Is a sensor available? (Set Available = 1 if a digital sensor or the pressure simulation is used)
2	Enable	BOOL	RW		NV		0	1	1	0 :Not used for pressure control, object Pressure Sensor 1 can be used for monitoring 1 :Used for pressure control (to build Actual Pressure value)
3	Data Unit	SINT8	RW		NV		0	7	4	0 :Pa 1 :kPa 2 :bar 3 :mbar 4 :Torr 5 :mTorr 6 :psia 7 :psig
4	Upper Limit Data Value	FLOAT	RW		NV	refers to 2401:03			1.0	
5	Lower Limit Data Value	FLOAT	RW		NV	refers to 2401:03			0.0	
6	Upper Limit Voltage Value	FLOAT	RW		NV	volt			10.0	
7	Lower Limit Voltage Value	FLOAT	RW		NV	volt			0.0	
8	Scale	SINT8	RW		NV		0	1	0	0 :Linear 1 :Logarithmic (not supported yet)
9	Voltage Per Decade	FLOAT	RW		NV	volt			0.0	
A	Zero Adjust Enable	BOOL	RW		NV		0	1	1	
B	Zero Adjust Offset Value [SFS]	FLOAT	RW		NV	SFS			0.0	Value 1.0 means sensor full scale. For example for a 0-10 Volt gauge the value 0.1 means 1 Volt
F	Filter Enable	BOOL	RW		NV		0	1	0	
10	Filter Time	FLOAT	RW		NV	sec	0.0	1.0	0.0	
12	Input Source	SINT8	RW		NV		0	2	0	0 :Analog 1 :Digital 2 :Simulation
14	Pressure Input Digital Sensor	FLOAT	RW	TX/RX	V	mbar*				Only used if Input Source = Digital. In this case the actual sensor pressure value is send by the customer via EtherCAT.
18	Pressure Sensor	FLOAT	RO	TX	V	mbar*				Pressure value for sensor
2405	Sensor Crossover	REC								
1	Crossover Mode	SINT8	RW		NV		0	1	0	0 : Soft Switch Actual Pressure is a summation of the pressure value of sensor 1 pressure and sensor 2 1 : Hard Switch Actual Pressure is the value of sensor 1 or sensor 2 2 : Target Pressure If Target Pressure falls into low range sensor, the low sensor is used for Actual Pressure . In other case the high range sensor is used.
2	Threshold High [SFS low sensor]	FLOAT	RW		NV	SFS of low sensor	0.0	1.0	1	Defines the crossover area.

Index	SI Name	Data Type	Acc	Mapping	NV	Unit	Min	Max	Def	Description
3	Threshold Low [SFS low sensor]	FLOAT	RW		NV	SFS of low sensor	0.0	1.0	0.95	Example: Threshold High = 1.0 [SFS of low sensor] Threshold Low = 0.9 [SFS of low sensor] <u>Soft switch:</u> At pressure $\leq 0.9 \cdot \text{SFS}$ (low sensor): Actual Pressure = Sensor low pressure At pressure $0.95 \cdot \text{SFS}$ (low sensor): Actual Pressure = 50% * Sensor low pressure + 50% sensor high pressure At pressure $\geq 1.0 \cdot \text{SFS}$ (low sensor): Actual Pressure = Sensor high pressure <u>Hard switch:</u> At pressure increase over $1.0 \cdot \text{SFS}$ (low sensor): Actual Pressure = Sensor high pressure after Delay At pressure decrease under $0.9 \cdot \text{SFS}$ (low sensor): Actual Pressure = Sensor low pressure after Delay
4	Delay	FLOAT	RW		NV		0.0	10.0	0	Only relevant in Crossover Mode = Hard Switch
2601	Interface EtherCAT	REC								
1	EtherCAT State	UINT8	RO	TX	V		1	8		1:Init 2:Pre-OP 3:Bootstrap 4:Safe-Op 8:Op
2	Address	UINT16	RO	TX	V		0	4095		Defined by the address switches on the valve controller
3	Connection Loss Reaction Enable	BOOL	RW		NV		0	1	1	
4	Connection Loss Reaction Functionality	SINT8	RW		NV		0	1	1	0:Open 1:Close

Index	SI Name	Data Type	Acc	Mapping	NV	Unit	Min	Max	Def	Description
2610	Scaling	REC								
1	Position Unit	SINT16	RW		NV		0	7	3	0: 0 - 1 1: 0 - 10 2: 0 - 90 3: 0 - 100 4: 0 - 1000 5: 0 - 10000 6: 0 - 100000 7: User specific Range is defined by Value Closest Position and Value Open Position
2	Value Closest Position	FLOAT	RW		NV				0.0	Only used if Position Unit is set to User Specific. Defines the value for the closest position.
3	Value Open Position	FLOAT	RW		NV				1.0	Only used if Position Unit is set to User Specific. Defines the value for the open position.
5	Pressure Unit	SINT16	RW		NV		0	7	3	0: Pa 1: kPa 2: Bar 3: mBar 4: Torr 5: mTorr 6: Psi 7: User specific Range is defined by Value Pressure 0 and Value Pressure Sensor Full Scale
6	Value Pressure 0	FLOAT	RW		NV				0.0	Only used if Pressure Unit is set to User specific. Defines the value for pressure 0.
7	Value Pressure Sensor Full Scale	FLOAT	RW		NV				1.0	Only used if Pressure Unit is set to User specific. Defines the value for actual sensor full scale.
9	Digital Sensor 1 Input Pressure Unit	SINT16	RW		NV		0	7	5	0: Pa 1: kPa 2: Bar 3: mBar 4: Torr 5: mTorr 6: psi 7: User specific Range is defined by Value Pressure 0 and Value Pressure Sensor Full Scale
A	Value Sensor 1 Lower Limit Data Value	FLOAT	RW		NV				0.0	Only used if Pressure Unit is set to User specific. Defines the value for the pressure value 2401:05 (Sensor1.Lower Limit Data Value)
B	Value Sensor 1 Upper Limit Data Value	FLOAT	RW		NV				1.0	Only used if Pressure Unit is set to User specific. Defines the value for the pressure value 2401:04 (Sensor1.Upper Limit Data Value)
D	Digital Sensor 2 Input Pressure Unit	SINT16	RW		NV		0	7	5	0: Pa 1: kPa 2: Bar 3: mBar 4: Torr 5: mTorr 6: psi 7: User specific Range is defined by Value Pressure 0 and Value Pressure Sensor Full Scale

Index	SI Name	Data Type	Acc	Mapping	NV	Unit	Min	Max	Def	Description
E	Valve Sensor 2 Lower Limit Data Value	FLOAT	RW		NV				0.0	Only used if Pressure Unit is set to User specific. Defines the value for the pressure value 2402:05 (Sensor2.Lower Limit Data Value)
F	Valve Sensor 2 Upper Limit Data Value	FLOAT	RW		NV				1.0	Only used if Pressure Unit is set to User specific. Defines the value for the pressure value 2402:04 (Sensor2.Upper Limit Data Value)
2C01	Power Connector IO Digital Input 1	REC								Logic Inputs available on the valve power connector
2C02	Power Connector IO Digital Input 2	REC								Logic Inputs available on the valve power connector
1	Enable	BOOL	RW		NV		0	1	1	
2	State	BOOL	RO	TX	V		0	1		0:Signal level low 1:Signal level high
3	Functionality	SINT8	RW		NV		0	1	0	0:Interlock Open 1:Interlock Close
4	Inverted	BOOL	RW		NV		0	1	0	
2C03	Power Connector IO Digital Output 1	REC								Logic Outputs available on the valve power connector
2C04	Power Connector IO Digital Output 2	REC								Logic Outputs available on the valve power connector
1	Enable	BOOL	RW		NV		0	1	1	
2	State	BOOL	RO	TX	V		0	1		0:Signal level low 1:Signal level high
3	Functionality	SINT8	RW		NV		0	1	0	0:Open 1:Close
4	Inverted	BOOL	RW		NV		0	1	0	
2E00	Power Fail Option	REC								Only valid if a Power Fail Option is available
1	Enable	BOOL	RW		NV				1	
2	State	SINT8	RO	TX	V		0	3		0:Battery is Charging 1:Ready to Use 2:Active 3:Failure
3	Functionality	SINT8	RW		NV		0	1	1	0:Open 1:Close
4	Delay	FLOAT	RW		NV	sec	0.0	2.0	0.5	
5	Battery Voltage	FLOAT	RO		V	volt				
6	Power Fail Cycles	UINT16	RW	TX	NV					

Index	SI Name	Data Type	Acc	Mapping	NV	Unit	Min	Max	Def	Description	
2F00	VAT Profile Objects										
		REC									
1	Target Pressure	SINT32	RW	TX/RX	V	mbar*	0.0	SFS			
2	Target Position	SINT32	RW	TX/RX	V	pos*	0.0*	100.0*			
3	Pressure Input Digital Sensor 1	SINT32	RW	TX/RX	V	mbar*					
4	Pressure Input Digital Sensor 2	SINT32	RW	TX/RX	V	mbar*					
5	Control Mode Setpoint (possibly not available)	UINT8	RW	TX/RX	V		1	7	1: Homing 2: Position 3: Close	4: Open 5: Pressure 6: Hold 7: Learn	
6	General Control Setpoint	UINT16	RW	TX/RX	V		0	31	Bit 0: Zero Bit 1: Not used Bit 2: Ping Pong TX Bit	Bit 3: Not Used Bit 4: Access Mode Locked Bit 5-15: Not Used	
7	Pressure Ramp Time	FLOAT	RW	TX/RX	NV **	sec	0.0	1000000.0	1.0		
8	Actual Pressure	SINT32	RO	TX	V	mbar*					
9	Pressure Sensor 1	SINT32	RO	TX	V	mbar*					
A	Pressure Sensor 2	SINT32	RO	TX	V	mbar*					
B	Actual Position	SINT32	RO	TX	V	pos*	0.0*	100.0*			
C	Control Mode (possibly not available)	UINT8	RO	TX	V		0	14	0: Init 1: Homing 2: Position 3: Close 4: Open	5: Pressure Control 6: Hold 7: Learn 8: Interlock Open 9: Interlock Close 12: Power Failure 13: Safety 14: Error	
D	General Status	UINT16	RO	TX	V		0	4095	Bit 0: Fieldbus data valid Bit 1: Zero executed Bit 2: Ping pong RX-Bit Bit 3: Pressure simulation	Bit 4: Target pressure reached Bit 5-6: Not used Bit 7-8: Access Mode Bit 9: Warnings active Bit 10: Sealing state Bit 11: Interlock active Bit 12-15: Not used	
E	General Warnings	UINT16	RO	TX	V		0	15	Bit 0: Not used Bit 1: Learn data set	Bit 2: Not used Bit 3: Power Failure Battery Bit 4-15: Not used	
F	Extended Warnings	UINT16	RO	TX	V		0	4095	Bit 0: Remote Control not possible Bit 1: Actual Control Mode Setpoint not allowed Bit 2: Zero disabled Bit 3: PFO deactivated	Bit 4: Not Used Bit 5: Out Of Range: Pressure Setpoint Bit 6: Out Of Range: Position Setpoint Bit 7-9 Not Used Bit 10: Out Of Range: Control Mode Setpoint Bit 11: Out Of Range: General Control Setpoint Bit 12-15: Not Used	

* Scaling:

Position:

Use object **Scaling 2610h** (SI 01h, 02h and 03h) to adjust the value range of all position objects
Note: In case of an isolation functionality is available the minimum position does not mean the isolation state

Pressure:

Use object **Scaling 2610h** (SI 05h, 06h and 07h) to adjust the value range of all pressure objects

Digital Pressure Sensor 1:

Use object **Scaling 2610h** (SI 09h, 0Ah and 0Bh) to adjust the value range of object Pressure Input Digital Sensor 1

Digital Pressure Sensor 2:

Use object **Scaling 2610h** (SI 0Dh, 0Eh and 0Fh) to adjust the value range of object Pressure Input Digital Sensor 2

** In case of **Store Control Parameter Volatile (2330h)** is 1 (true) the value will not be stored in nonvolatile memory.

*** Valve series specific

4.12.8.4 Manufacturer specific IC compatible object entries

Index SI	Name	Data Type	Acc	Mapping	NV	Unit	Min	Max	Def	Description
20E6	Sensor operation mode	UINT8	RW	RT	NV		0	10	1	0:no sensor 1:sensor 1 3:sensor 2 2:sensor 1 high, sensor 2 low, Crossover Mode Soft Switch 4:sensor 2 high, sensor 1 low, Crossover Mode Soft Switch 7:sensor 1 high, sensor 2 low, Crossover Mode Target Pressure 8:sensor 2 high, sensor 1 low, Crossover Mode Target Pressure 9:sensor 1 high, sensor 2 low, Crossover Mode Hard Switch 10:sensor 2 high, sensor 1 low, Crossover Mode Hard Switch
20E7	Sensor full scale ration	FLOAT	RW		NV		1.0	1000.0	10.0	Full scale ratio between high sensor and low sensor
2118	Maximum learn pressure	UINT16	RW	TX/RX	V		0	1000	1000	Max. learn pressure in % of SFS
2119	Learn state	UINT16	RO	TX	V					See table below
2190	Valve speed	UINT16	RW	TX/RX	NV		0	1000	1000	Valve speed during position and pressure control
2199	Pressure Control Algorithm	UINT8	RW	TX/RX	NV		0	3	0	0 = adaptive downstream (default) 1 = Fixed 1 2 = Fixed 2 3 = soft pump Refer to chapter: «Pressure control configuration»
219A	Sensor delay (adaptive downstream)	FLOAT	RW	TX/RX		sec	0.0	1.0	0.0	
219B	Ramp time (adaptive downstream)	FLOAT	RW	TX/RX		sec	0.0	1'000'000.0	0.0	
219C	Ramp mode (adaptive downstream)	UINT8	RW	TX/RX			0	1	0	0 = Constant Time 1 = Constant Slope
219E	Gain factor (adaptive downstream)	FLOAT	RW	TX/RX			0.0001	7.5	1.0	
21A5	Ramp time (fixed 1)	FLOAT	RW	TX/RX		sec	0.0	1'000'000.0	0.0	
21A6	Ramp mode (fixed 1)	UINT8	RW	TX/RX			0	1	0	0 = Constant Time 1 = Constant Slope
21A7	Control direction (fixed 1)	UINT8	RW	TX/RX			0	1	0	0 = downstream 1 = upstream
21A8	P-Gain (fixed 1)	FLOAT	RW	TX/RX			0.001	100	0.1	
21A9	I-Gain (fixed 1)	FLOAT	RW	TX/RX			0.0	100.0	0.1	
21AF	Ramp time (fixed 2)	FLOAT	RW	TX/RX		sec	0.0	1'000'000.0	0.0	
21B0	Ramp mode (fixed 2)	UINT8	RW	TX/RX			0	1	0	0 = Constant Time 1 = Constant Slope
21B1	Control direction (fixed 2)	UINT8	RW	TX/RX			0	1	0	0 = Downstream 1:Upstream
21B2	P-Gain (fixed 2)	FLOAT	RW	TX/RX			0.001	100	0.1	
21B3	I-Gain (fixed 2)	FLOAT	RW	TX/RX			0.0	100.0	0.1	
21B9	Ramp time (soft pump)	FLOAT	RW	TX/RX		sec	0.0	1'000'000.0	0.0	
21BA	Ramp mode (soft pump)	UINT8	RW	TX/RX			0	1	0	0 = Constant Time 1 = Constant Slope
21BC	P-Gain (soft pump)	FLOAT	RW	TX/RX			0.001	100	0.1	
2258	Reset node	UINT8	RW				0	1	0	

5 Operation



WARNING

Unqualified personnel

Inappropriate handling may cause serious injury or property damage.
Only qualified personnel are allowed to carry out the described work.



WARNING

Valve opening

Risk of serious injury.
Human body parts must be kept out of the valve opening and away from moving parts.
Do not connect the controller to power before the valve is installed complete into the system.

5.1 Remote and Local Operation

5.1.1 Access Mode

Defines which interface, remote (EtherCAT) or service (CPA), can control the valve.

Access Mode	Control Permission	Comment
Local	CPA	
Remote	EtherCAT Master	CPA can switch to Local
Locked	EtherCAT Master	CPA can't switch to Local



Power On state is 'Remote'

5.1.2 Remote operation

This product is equipped with a EtherCat interface to allow for remote operation. See section «EtherCat interface» for details.

'Control Performance Analyzer' software may be used for monitoring during remote control.



In case 'Control Performance Analyzer' is used, make sure 'Remote' button is pushed to enable for remote operation.

5.1.3 Local operation

Local operation means that the valve is operated via the service port using a computer. You can use our software 'Control Performance Analyzer' for Local operation, which is integrated in the controller. The software is beneficial especially for setup, testing and maintenance.

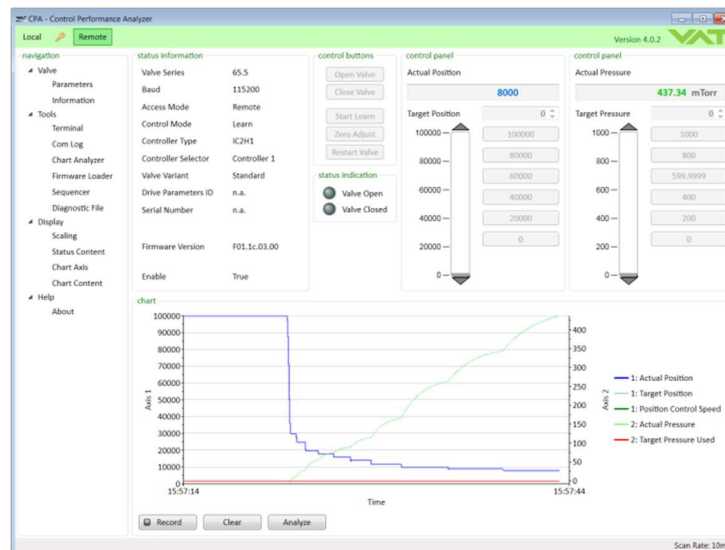

When communication to service port is interrupted the valve will change to remote operation. So when service cable will be disconnected or software will be shut down, the valve returns automatically to remote operation. This may result in an **immediate movement** of the valve depending on remote control.

5.2 Basic Functions

5.2.1 Close valve

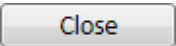
Local operation: CPA	Remote operation: Refer to chapter 'OUTPUT Buffer'
Push  button	OUTPUTBUFFER → CONTROL MODE SETPOINT = 3

5.2.2 Open valve

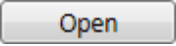
Local operation: CPA	Remote operation: Refer to chapter 'OUTPUT Buffer'
Push  button	OUTPUTBUFFER → CONTROL MODE SETPOINT = 4

5.2.3 Position control

The valve position is directly controlled according to the position setpoint.

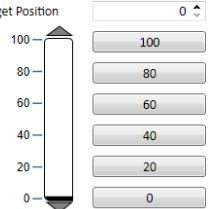
Local operation: CPA	Remote operation: Refer to chapter 'OUTPUT Buffer'
<p>Use target position control</p> <p>Target Position <input type="text" value="0"/></p> 	<p>OUTPUTBUFFER → TARGET POSITION = desired position OUTPUTBUFFER → CONTROL MODE SETPOINT = 2</p>

5.2.4 Pressure control



To prepare valve for PRESSURE CONTROL perform complete «Setup procedure». The valve has parameters that may be modified to tune pressure control performance. Refer to «Tuning of control performance».

The included PID controller controls the chamber pressure according to the pressure setpoint by means of the valve position.

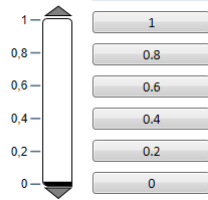
Local operation: CPA	Remote operation: Refer to chapter 'OUTPUT Buffer'
<p>Use target pressure control</p> <p>Target Pressure <input type="text" value="0"/></p> 	<p>OUTPUTBUFFER → TARGET PRESSURE = desired pressure OUTPUTBUFFER → CONTROL MODE SETPOINT = 5</p>

6 Trouble shooting

6.1 General

Failure	Check	Action
Display does not light up	- 24 V power supply	- Connect valve to power supply according to 'Power, ground and sensor connection' and make sure that power supply is working.
Remote operation does not work	- Local operation via service port active	- Switch to remote or locked operation Refer to 'Remote and local operation'
	- Safety mode active Check for S on display	- Check 'Drive Power Enable Switch' Refer to 'Power, ground and sensor connection'
	- Interlock mode active Check for I on display	- Check Digital Input Refer to 'Power connector IO' → 'Digital Input'
POSITION CONTROL does not work	- Safety mode active Check for S on display	- Check 'Drive Power Enable Switch' Refer to 'Power, ground and sensor connection'
	- Interlock mode active Check for I on display	- Check Digital Input Refer to 'Power connector IO' → 'Digital Input'
	- POSITION CONTROL selected, check for A on display?	- Select POSITION CONTROL mode. Refer to 'Control Mode' in 'EtherCAT' interface
Pressure reading is wrong Pressure reading is negative	- Sensor connection	- Refer to 'Power, ground and sensor connection'
	- ZERO done?	- Perform ZERO when base pressure is reached. Refer to 'Pressure Sensor' → 'Zero Adjust'
	- Does sensor power supply provide enough power for sensor(s)?	- Verify sensor supply voltage.
ZERO does not work	- ZERO disabled?	- Enable ZERO. Refer to 'Pressure Sensor' → 'Zero Adjust'
	- Sensor voltage shifting?	- Wait until sensor does not shift any more before Performing ZERO.
Pressure is not '0' after ZERO	- System pumped to base pressure?	- OPEN VALVE and bring chamber to base pressure before performing ZERO.
	- Sensor offset voltage exceeds $\pm 1.4V$	- Adjust the offset direct at the sensor - Check function of the sensor.
PRESSURE CONTROL does not work	- PRESSURE CONTROL selected, check for P on display?	- Select PRESSURE CONTROL mode. Refer to 'Control Mode' in 'EtherCAT' interface
	- LEARN done?	- Perform LEARN. Refer to 'Pressure control' → 'Adaptive algorithm' → 'Learn'
	- Sensor signal ok?	- Refer to 'Pressure Sensor'
	- Pressure control setup done	- Refer to 'Pressure control'
PRESSURE CONTROL not optimal	- LEARN successfully done?	- Perform LEARN. Check 'Status' and 'Warning Info' in 'Pressure control' → 'Adaptive algorithm' → 'Learn'
	- ZERO performed before LEARN?	- Perform ZERO then repeat LEARN. Refer to 'Pressure Sensor' → 'Zero Adjust'
	- Was gas flow stable during LEARN?	- Repeat LEARN with stable gas flow. Refer to 'Pressure control' → 'Adaptive algorithm' → 'Learn'
	- Tuning done?	- Tune valve for application. Refer to the tuning sections in 'Pressure Control'
	- Is sensor range suited for application?	- Use a sensor with suitable range (controlled pressure should be >3% and < 98% of sensor full scale).
	- Noise on sensor signal?	- Make sure a shielded sensor cable is used.

6.2 Errors

6.2.1 Controller Display

Description	Digit 1	Digit 2	Digit 3	Digit 4
Error number (xyz)	E	x	y	z
alternately (if error code exist)				
Error code	-	u	v	w

6.2.2 Error numbers



Error numbers are three-digit decimal numbers (**xyz**) whereas:

x = component	y = mode	z = error type
1 = All Motor Units 2 = Motor Unit 1 3 = Motor Unit 2 4 = Motor Unit 3 8 = Other	0 = Homing 2 = Operation Mode 8 = Other	0 = Position Error ¹⁾ 1 = Not running: No communication with component x 2 = Error State: component x is running but in Status Error 8 = Other

¹⁾ Only in combination with component 1, 2, 3

6.2.3 Error code

Code <small>u v w</small>	Description	Solution
1 1	No valve connected	Connect valve controller to the valve
2	Nonvolatile memory failure	Replace valve controller
3	Analog digital converter of sensor input failure	Replace valve controller
4	Initialization of motion controller failed	<ul style="list-style-type: none"> • Wrong motion controller firmware version → Update motion controller firmware
5	Encoder index pulse not found	<ul style="list-style-type: none"> • Encoder failure • O-Ring sticking • 1)
6	Initialization of interface module failed	<ul style="list-style-type: none"> • Fieldbus: Valve firmware does not support interface type → Update valve firmware • Wrong interface firmware version → Update interface firmware
7	Initialization of external drive EEPROM failed	<ul style="list-style-type: none"> • Check cables
1 0	Closing position can't be reached	<ul style="list-style-type: none"> • 1)
1 1	Homing position can't be reached	<ul style="list-style-type: none"> • 1) • Plate not mounted
1 2	Motion controller: Internal voltage error	<ul style="list-style-type: none"> • Check power supply
1 3	Motion controller: Internal error temperature	<ul style="list-style-type: none"> • Check for a heat accumulation
1 4	Motion controller: Unexpected behavior	Contact vat support <ul style="list-style-type: none"> • Axis inverted • Encoder not connected • Break not released
1 5	Motion controller: Target position can't be reached	<ul style="list-style-type: none"> • 1) • Current settings
1 6	Motion controller: Position minimal conductance cannot be reached	<ul style="list-style-type: none"> • 1) • Check Plate and Seal ring • Check Parameter "Isolation Position Enter [r]"
1 7	Motion controller: Position to push back the Differential Plate cannot be reached	<ul style="list-style-type: none"> • 1) • Check Different Plate • Check Parameter "Differential Plate Push Back Position [r]"
1 8	Motion controller: Minimal isolation position cannot be reached	<ul style="list-style-type: none"> • 1) • Check Plate and Seal ring • Check Parameter "Isolation Position [r]"
2 0	Break slippery detected	Replace actuator
3 0	SFV: Motion controller failure in master-slave communication	Contact vat support
4 0	Compressed air error	Check compressed air
4 2	Power supply, low voltage detected	Check if power supply is ok and is able to deliver needed power
9 6	SFV: Position deviation axis1 to axis2 at homing procedure	<ul style="list-style-type: none"> • O-Ring sticking • 1)
9 7	SFV: Position deviation axis1 to axis2 at operating	1)
9 8	Position error during closing procedure	1)
9 9	Position error at operating	1)
2 0 0	Valve configuration error, not possible to operate the valve with these configuration	Contact VAT support

Code	Description	Solution
<i>u v w</i>		
7 0 1	Wrong ident code axis 1	Check wiring
7 0 2	Wrong ident code axis 2	
7 0 3	Wrong ident code axis 2 AND axis 1	
7 0 4	Wrong ident code axis 3	
7 0 5	Wrong ident code axis 3 AND axis 1	
7 0 6	Wrong ident code axis 3 AND axis 2	
7 0 7	Wrong ident code axis 3 AND axis 2 AND axis 1	
7 7 7	Do not operating mode active	

1) Mechanical movement problem:

- Check for differential pressure
- Remove foreign object in movement area
- Eliminate tight movement
- Repair mechanical failure



If you need any further information, please contact one of our service centers. You will find the addresses on our website: www.vatvalve.com

7 Maintenance

	<p style="text-align: center;">⚠ WARNING</p> <p>Unqualified personnel Inappropriate handling may cause serious injury or property damage. Only qualified personnel are allowed to carry out the described work.</p>
	<p style="text-align: center;">⚠ WARNING</p> <p>Valve opening Risk of serious injury. Human body parts must be kept out of the valve opening and away from moving parts. Disconnect power on controller before doing any work.</p>
	<p style="text-align: center;">⚠ CAUTION</p> <p>Hot valve Heated valve may result in minor or moderate injury. Do not touch valve and heating device during operation. Once heating is switched off (valve and system) await until the valve is cooled down complete before doing any work.</p>
	<p style="text-align: center;">NOTICE</p> <p>Contamination Gate and other parts of the valve must be protected from contamination. Always wear clean room gloves when handling the valve.</p>

7.1 Drawing

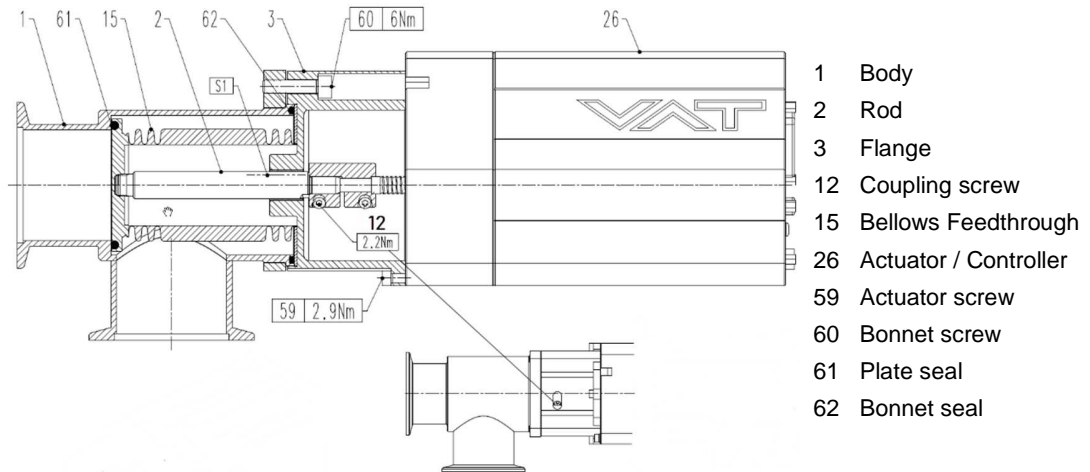

7.2 Replacement of vacuum seals

7.2.1 Dismount actuator / controller

7.2.1.1 Required tools

- Allen Wrench 5 mm
- Allen Wrench 3 mm
- Allen Wrench 2.5 mm
- O-ring removal tool (see chapter: Accessories)
- Vacuum grease (see chapter: Spare parts)
- Clean room wiper
- Isopropyl alcohol



The item numbers in brackets refer to chapter: «Drawing». For new «Plate seal and Bonnet seal refer to chapter: «Spare Parts»

1. Close the valve
2. Vent valve on both sides
3. Loosen coupling screw (12) and loosen and remove actuator screws (59)
4. Remove actuator / controller (26) from valve unit
5. Loosen and remove the bonnet screws (60)
6. Remove the flange (3)
7. Withdraw bellows feedthrough (15) carefully from valve body
8. Remove bonnet seal (62) by using an O-ring removal tool

7.2.2 Replacement of plate seal

1. Remove plate seal (61) from groove by using an O-ring removal tool
2. Check sealing surface and clean it with cleanroom wiper a little soaked with isopropyl alcohol
3. Put new plate seal (61) on groove and press it into groove at 4 opposite spots
4. Press remaining sections uniformly into groove

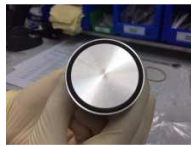

7.2.3 Mount actuator / controller

1. Check sealing surfaces of bonnet flange / valve seat and clean it with cleanroom wiper a little soaked with isopropyl alcohol
2. Put bonnet seal (62) into valve body



3. Insert bellows feedthrough (15) carefully



Do not cant

4. Lubricate the rod (2) in the frame of bushing (0.05 gram, N-6951-40) and insert the flange (3) carefully, clean the end of rod in the frame of coupling (no grease)



5. Fasten bonnet screws (60) uniformly and in crosswise order, torque 6 Nm
6. Turn coupling out of the body



7. Insert the coupling of controller (26) on rod (2) until it stops and tighten the coupling screw (12) with a torque of 2.2 Nm



8. Turn controller over stop (flange) and on the right position (see drawing), and fasten the actuator screws (59) uniformly and in crosswise order with a torque of torque 3 Nm



7.3 Replacement of Option board

	NOTICE
	<p>Electrostatic discharge</p> <p>Electronic components could be damaged.</p> <p>All work on the control and actuating unit has to be done under ESD protected environment to prevent electronic components from damage.</p>

	NOTICE
	<p>Burned connector pins (spark)</p> <p>Connector pins or electronic parts could be damaged, if plugged and unplugged under power.</p> <p>Do not plug or unplug connectors under power.</p>

The option board may or may not be equipped in your valve depending on the order. Refer to page 1 of this manual to check valve version. This board includes the optional modules for the valve which are:

- ± 15 VDC sensor power supply (SPS)
- Power failure option (PFO)

It is available in 3 versions. These are:

- SPS module only
- PFO module only
- SPS and PFO module

The modules may be retrofitted or replaced easily. The battery lifetime of the PFO module depends on the ambient temperature (see below). To assure PFO function the option board must be replaced after battery life has expired. For ordering number of the modules refer to chapter «Spare parts».

7.3.1.1 Durability of power fail battery

The curves in the graph show the estimated life of Ultra Cap PFO in the worst condition (max. sensor load = 1 A, valve heating temperature = 150 °C).

If the SPS is not fully loaded (< 1 A) or heating temperature of valve body is lower than 150 °C, the corresponding life time curve will be somewhere in between the upper and the lower curve.

Therefore please determine the equivalent maintenance period for replacing the Ultra Cap battery (Option board).

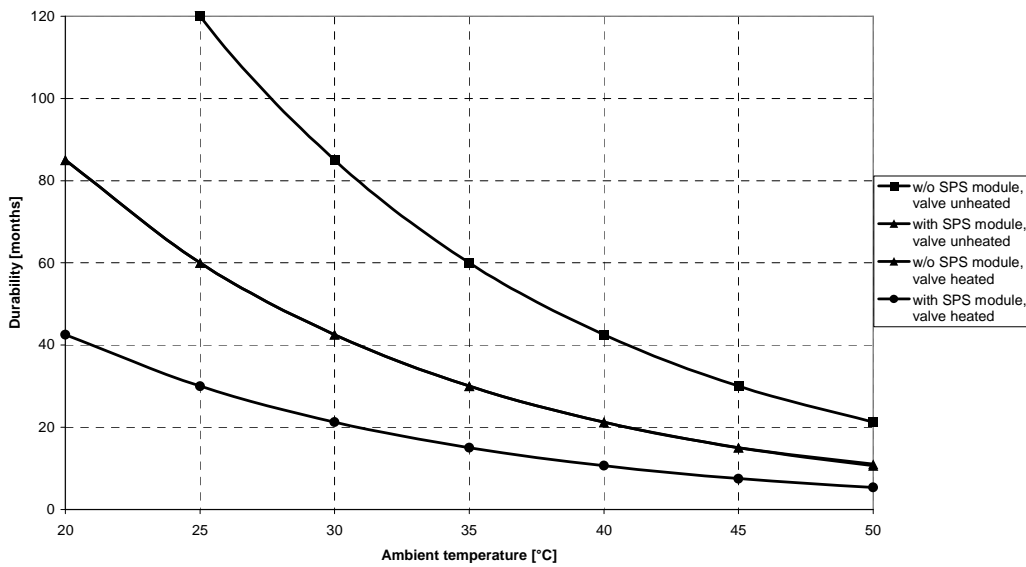

This graph shows estimated life of Ultra Cap PFO for reference and not as guaranteed value.

7.3.1.2 Retrofit / replacement procedure

View on control and actuating unit:

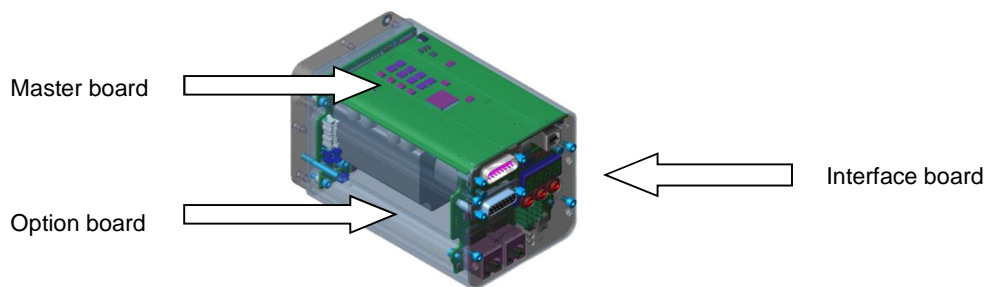



All boards have a fixed position into control and actuating unit. It is not possible to fit a board in other position as shown in picture above! Do not try out other positions, which maybe destroy the socket of boards!

7.3.1.3 Required tools

- Allen Wrench 2 mm / 2.5mm
- Allen Wrench 3 mm

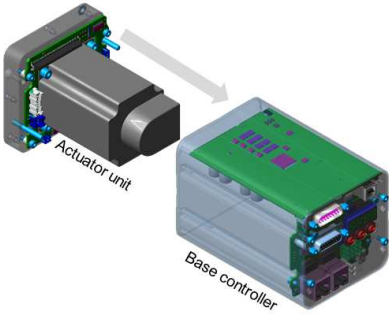

If you need any further information, please contact one of our service centers. You can find the addresses on our website: www.vatvalve.com.

Description		Required tool
 Make sure that the valve is in closed position 1. Vent vacuum system, disconnect electrical connections and remove valve from vacuum system. If you only replace control and actuating unit, the valve can remain in the system.  Take care not to damage sealing surface! Attention! Do not move the plate by hands when control an actuating unit is installed.		Depending on flange screws
2. Unfasten clamp coupling (through whole in intermediate flange)		Allen Wrench: steel coupling 2.5 mm
3. Unfasten the 4 connection bolts and separate the intermediate flange and the actuator.		Allen Wrench 3 mm
4. Replacement of the option board / whole controller Unfasten the two bolts from bottom side and and dismount the controller from the actuator unit. The SPS/PFO option board has to be mounted/ dismounted from bottom side of the controller. The Controller and Interface board are fix connected and shall not be dismounted.  work on an ESD-protected working space If you need any further information, please contact one of our service centers. You can find the addresses on our website: www.vatvalve.com		
5. Assemble base controller and actuator unit. Tighten mounting screws adequately. Assemble the intermediate flange and the actuator. Tighten mounting screws adequately.		Allen Wrench: 3mm
6. Tighten clamp coupling: <ul style="list-style-type: none"> • with steel coupling 2.2 Nm 		Allen Wrench: steel coupling 2.5 mm
7. Reinstall valve into vacuum system according to chapter «Installation».		



If you need any further information, please contact one of our service centers. You can find the addresses on our website: www.vatvalve.com.

8 Repairs

Repairs may only be carried out by the VAT service staff. In exceptional cases, the customer is allowed to carry out the repairs, but only with the prior consent of VAT.

Please contact one of our service centers. You will find the addresses on our website www.vatvalve.com.

9 Dismounting and Storage

	⚠ WARNING
	<p>Unqualified personnel Inappropriate handling may cause serious injury or property damage. Only qualified personnel are allowed to carry out the described work.</p>

9.1 Dismounting

	⚠ CAUTION
	<p>Hot valve Heated valve may result in minor or moderate injury. Do not touch valve and heating. Once heating is switched off (valve and system) await until the valve is cooled down complete before doing any work.</p>

	NOTICE
	<p>Contamination Gate and other parts of the valve must be protected from contamination. Always wear clean room gloves when handling the valve.</p>

	NOTICE
	<p>Valve in open position Valve body may become damaged if valve gate is in open position. Move valve gate to the closed position before dismantling the valve.</p>

1. Close the valve
2. For dismantling the valve please follow the instructions of chapter: «Installation», however in reverse order.

9.2 Storage

NOTICE	
	<p>Wrong storage</p> <p>Inappropriate temperatures and humidity may cause damage to the product.</p> <p>Valve must be stored at:</p> <ul style="list-style-type: none">– relative humidity between 10% and 70%– temperature between +10 °C and +50 °C– non-condensing environment

NOTICE	
	<p>Inappropriate packaging</p> <p>Product may get damaged if inappropriate packaging material is used.</p> <p>Always use the original packaging material and handle product with care.</p>

1. Clean / decontaminate valve.
2. Cover all valve openings with a protective foil.
3. Pack valve appropriately, by using the original packaging material.

10 Packaging and Transport

	⚠ WARNING
	Unqualified personnel Inappropriate handling may cause serious injury or property damage. Only qualified personnel are allowed to carry out the described work.

	⚠ WARNING
	Harmful substances Risk of injury in case of contact with harmful substances. Remove harmful substances (e. g. toxic, caustic or microbiological ones) from valve before you return the valve to VAT.

	NOTICE
	Inappropriate packaging Product may get damaged if inappropriate packaging material is used. Always use the original packaging material and handle product with care.



- When returning products to VAT, please fill out the VAT form «Declaration of Chemical Contamination of Vacuum Valves and Components» and send it to VAT in advance. The form can be downloaded from our website www.vatvalve.com (Section: Services – Aftersales).
- If products are radioactively contaminated, the VAT form «Contamination and Radiation Report» must be filled out. Please contact VAT in advance.
- If products are sent to VAT in contaminated condition, VAT will carry out the decontaminating procedure at the customer's expense.

10.1 Packaging

	NOTICE
	<p>Valve in open position</p> <p>Valve mechanism may get damaged if valve is in open position. Make sure that the valve is closed.</p>

1. Cover all valve openings with a protective foil.
2. Pack valve appropriately, by using the original packaging material.



VAT disclaims any liability for damages resulting from inappropriate packaging.

10.2 Transport

	NOTICE
	<p>Inappropriate packaging</p> <p>Product may get damaged if inappropriate packaging material is used. Always use the original packaging material and handle product with care.</p>





VAT disclaims any liability for damages resulting from inappropriate packaging.

11 Disposal

Observe the local regulations for disposal

	⚠ WARNING
	<p>Harmful substances Environmental pollution. Discard products and parts according to the local regulations.</p>

	⚠ WARNING
	<p>Unqualified personnel Inappropriate handling may cause serious injury or property damage. Only qualified personnel are allowed to carry out the disposal.</p>

	⚠ CAUTION
	<p>Risk of damage Indicates a hazardous situation which, if not avoided, may result in minor or moderate injury. A large number of diverse materials are used in the product. Some of them could cause human and machine damage in the case of improper handling.</p> <ul style="list-style-type: none"> • Observe local regulations in regard to waste disposal without fail. • Commission an authorized waste disposal company for the professional disposal of your waste.

	NOTICE
	<p>Improper disposal Some built-in materials can cause damage, if improperly handled. - When disposing, take into account all the different materials used</p>



- Hire an authorised waste disposal company to dispose of the waste in a professional manner.

The following list should help you to dismantle your product without making serious errors and to properly separate out the product scrap.

Material groups	Hazard level
non-ferrous metals	high
stainless steel	low
aluminium	low
plastics	medium
lubricants	high
electronic scrap	high
batteries	very high
cables and wires	medium
motors	medium
seals and rubber parts	high

12 Spare parts



NOTICE

Non-original spare parts

Non-original spare parts may cause damage to the product.
Use original spare parts from VAT only.



- Please specify the fabrication number of the product when you place an order for spare parts; see chapter: «Identification of product». This is to ensure that the appropriate spare parts are supplied.
- VAT makes a difference between spare parts that may be replaced by the customer and those that need to be replaced by the VAT service staff.
- The following table(s) contain spare parts that may be replaced by the customer. If you need any other spare parts, please contact one of our service centers. You will find the addresses on our website www.vatvalve.com.

12.1 Drawing

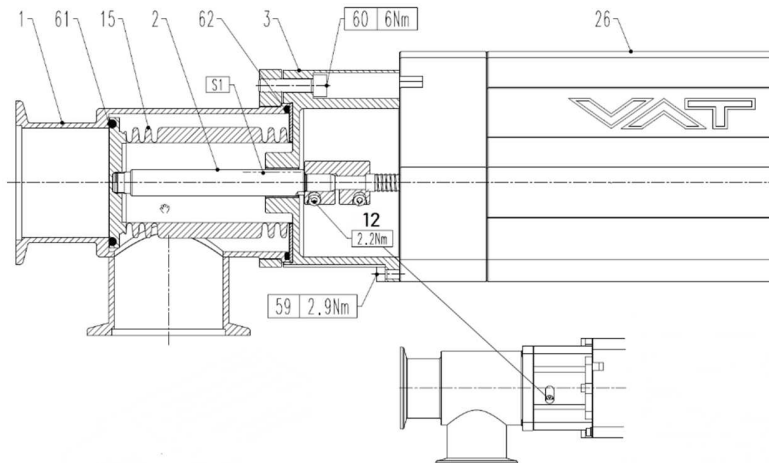

- | | |
|----|-----------------------|
| 1 | Body |
| 2 | Rod |
| 3 | Flange |
| 12 | Coupling screw |
| 15 | Bellows Feedthrough |
| 26 | Controller / Actuator |
| 59 | Actuator screw |
| 60 | Bonnet screw |
| 61 | Plate seal |
| 62 | Bonnet seal |



All "Item" refer to chapter «Drawing»

12.1.1 Valve unit

Item	Description		
	Valve size Product ordering number	DN 40 / 2" 62032 -	DN 50 / 2" 62034 -
15	Bellows Feedthrough	229542	750472
61	Plate seal	N-5100-223	N-5100-226
62	Bonnet seal	N-5100-139	N-5100-144

12.1.2 Control and actuating unit

Item	Description	Part number
26	Control and actuating unit	Too many to list. Please contact VAT.
	Option board with SPS module (±15 VDC sensor power supply)	858530
	Option board with PFO module (power failure option)	858529
	Option board with SPS and PFO module	840512

12.1.3 Accessories

Description	Part number
24 VDC power supply unit (input: 100 – 240 VAC)	891528 (D-Sub15 connector)
Adapter for power supply with D-Sub9 connector	968180 or 735567 (D-Sub15 to D-Sub9)
Service cable (PC to valve Service connector)	809474 (USB A–B male-male)
O-ring removal tool	234859
VAT valve cleaning tool	305709

12.1.3.1 Centering ring with Viton o-ring

Description		DN 40 / 1.5" 62032 -	DN 50 / 2" 62034 -
Valve size Product ordering number			
Centering ring with Viton O-ring (for ISO-F installation only)	Aluminum	32032-QAZV	32034-QAZV
	Stainless steel	32032-QEZV	32034-QEZV

13 Appendix

This page left blank intentionally.