

Control gate valve with RS485 interface

Series 642 DN 63- 400 mm (I.D. 2.5" - 16")

This manual is valid for the valve ordering number(s):

642GJ -	(1 sensor input / analog outputs)
642GK -	(2 sensor inputs / analog outputs)
642AJ -	(1 sensor input / analog outputs / $\pm 15V$ SPS)
642AK -	(2 sensor inputs / analog outputs / $\pm 15V$ SPS)
642HJ -	(1 sensor input / analog outputs / PFO)
642HK -	(2 sensor inputs / analog outputs / PFO)
642CJ -	(1 sensor input / analog outputs / $\pm 15V$ SPS / PFO)
642CK -	(2 sensor inputs / analog outputs / $\pm 15V$ SPS / PFO)

SPS = Sensor Power Supply PFO = Power Failure Option

configured with firmware **600P.1G.00.06...07...08**

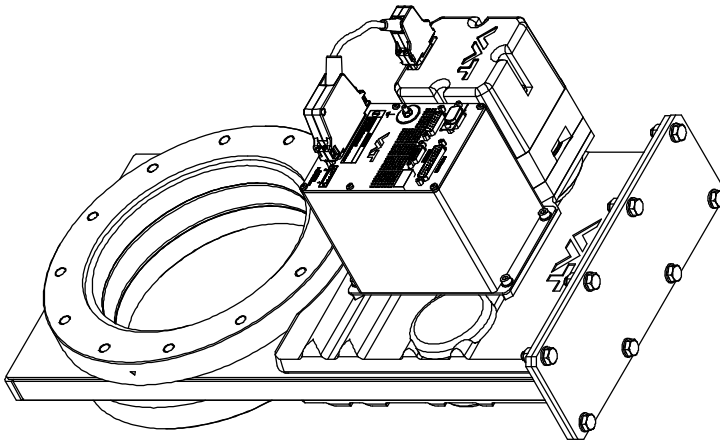

Sample picture

Imprint

Manufacturer VAT Vakuumventile AG, CH-9469 Haag, Switzerland

Website: www.vatvalve.com

Phone: +41 81 771 61 61

Fax: +41 81 771 48 30

Email: CH@vatvalve.com

Publisher VAT Vakuumventile AG, CH-9469 Haag, Switzerland

Editor VAT Vakuumventile AG, CH-9469 Haag, Switzerland

Print VAT Vakuumventile AG, CH-9469 Haag, Switzerland

Copyright © VAT Vakuumventile AG 2017

No part of these instructions may be reproduced in any way (photocopies, microfilms or any other reproduction processes) nor may it be manipulated with electronic systems, duplicated or distributed without written permission from VAT. Offenders are liable to pay damages.

The original VAT firmware and updated state of the art versions of the VAT firmware are intended for use with VAT products. The VAT firmware contains a limited, time unlimited user license. The VAT firmware may not be used for purposes other than those intended nor is it permitted to make copies of the VAT firmware. In particular, it is strictly forbidden to give copies of the VAT firmware to other people.

The use of trade names, brand names, trademarks, etc. in these Instructions does not entitle third parties to consider these names to be unprotected and to use them freely. This is in accordance with the meaning of the laws and acts covering brand names and trademarks.

Contents

1	Description of product.....	6
1.1	Identification of product	6
1.2	Use of product	6
1.3	Used abbreviations.....	6
1.4	Related documents.....	6
1.5	Important information.....	6
1.6	Technical data	7
1.6.1	Control and actuating unit	7
1.6.2	Valve unit	9
2	Safety	10
2.1	Compulsory reading material.....	10
2.2	Danger levels	10
2.3	Personnel qualifications.....	11
2.4	Safety labels.....	11
3	Design and Function.....	12
3.1	Design	12
3.2	Function.....	12
3.2.1	Pressure control system overview and function	13
3.2.2	Principle of a pressure control system	14
4	Installation	15
4.1	Unpacking	15
4.2	Installation into the system	16
4.2.1	Installation space condition	17
4.2.2	Connection overview.....	18
4.2.3	Installation procedure.....	19
4.3	Tightening torque	20
4.3.1	Mounting of CF-F flanges.....	20
4.3.2	Mounting with centering rings	20
4.3.3	Mounting with O-ring in grooves	21
4.4	Admissible forces	22
4.4.1	Requirements to sensor connection.....	23
4.5	Electrical connection.....	23
4.5.1	Ground connection.....	24
4.5.2	Sensor supply concepts	25
4.5.3	Power and sensor connection (+24 VDC sensors)	26
4.5.4	Power (+24 VDC) and sensor connection (± 15 VDC sensors) with opt. SPS module 28	
4.5.5	Service port connection.....	30
4.5.6	Function and Wiring	30
4.5.7	Digital inputs	33
4.5.8	RS485 network topology	34
4.5.9	Connection cable drawing.....	34
4.6	Initial operation.....	35
4.6.1	RS485 Interface configuration.....	35
4.6.2	Valve configuration	36
4.6.3	Sensor configuration	37
4.6.4	ZERO	37
4.6.5	LEARN (adaptive)	38
4.6.6	Pressure control configuration	40
4.6.7	Pressure control algorithm	43
4.7	Tuning of control performance.....	47
4.7.1	Tuning of control performance with adaptive pressure controller.....	48

4.7.2	Tuning of control performance with fixed PI pressure controller.....	54
4.7.3	Tuning of control performance with soft pump pressure controller.....	57
4.8	RS485 interface commands	59
4.8.1	RS485 command syntax	59
4.8.2	Addressed communication	59
4.8.3	Control commands	60
4.8.4	Inquiry commands	60
4.8.5	Setup commands	67
4.8.6	Pressure control algorithm	76
4.8.7	Error messages.....	81
5	Operation.....	82
5.1	Normal operation	82
5.1.1	Local operation.....	83
5.1.2	Remote operation.....	84
5.2	Close valve.....	85
5.3	Open valve.....	85
5.4	Position control	85
5.5	Pressure control.....	85
5.5.1	Pressure control operation with 2 sensors	86
5.6	Display information	87
5.6.1	Power up	87
5.6.2	Operation	88
5.6.3	Fatal error.....	88
5.6.4	Safety mode	88
5.6.5	Service indication	89
5.7	Operation during power up	89
5.8	Behavior in case of power failure.....	89
5.9	Operation under increased temperature	90
6	Trouble shooting	91
7	Maintenance.....	94
7.1	Maintenance intervals.....	94
7.2	Maintenance procedures	95
7.2.1	Replacement of gate seals and valve cleaning	96
7.2.2	Replacement of Option board	101
7.2.3	Retrofit / replacement procedure.....	103
8	Repairs	106
9	Dismounting and Storage	107
9.1	Dismounting.....	107
9.2	Storage	108
10	Packaging and Transport.....	109
10.1	Packaging.....	109
10.2	Transport	110
11	Disposal.....	111
12	Spare parts.....	112
12.1	Drawing	113
12.1.1	Valve unit with seals and grease.....	114
12.1.2	Controller.....	114
12.1.3	Accessories.....	115

13 Appendix..... 116

1 Description of product

1.1 Identification of product

The fabrication number and order number are fixed on the product directly or by means of an identification plate.

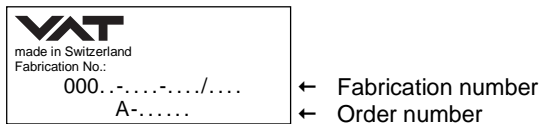

1.2 Use of product

This product is a control gate valve with isolation functionality. It is intended to use for downstream pressure control applications.
Use product for clean and dry vacuum applications only. Other applications are only allowed with the written permission of VAT.

1.3 Used abbreviations

Abbreviation	Description
CPA	Control Performance Analyzer
PFO	Power Failure Option
SFS	Sensor Full Scale
SPS	Sensor Power Supply
ADC	Analog-to-digital converter

1.4 Related documents

- Product Data Sheet
- Dimensional Drawing
- IOMI Heating device (if valve with heater)

1.5 Important information



This symbol points to a very important statement that requires particular attention.

Example:



Refer to chapter: «Technical data» for detailed information.

1.6 Technical data

1.6.1 Control and actuating unit

Description	
Power input ¹⁾ (α) [642 A / 642 G] [642 C / 642 H]	+24 VDC (±10%) @ 0.5 V pk- [connector: POWER] pk max. 50 W max. (operation of valve with max. load) without PFO ⁴⁾ 50 W plus 10 W for PFO ⁴⁾
Sensor power supply ²⁾ (β) [642 A / 642 C] Input Output	+24 VDC / 1500 mA max. [connector: POWER] ±15 VDC (±5%) / 1000 mA [connector: SENSOR] max.
Sensor power supply ²⁾ (β) [642 G / 642 H] Input Output	+ 24 VDC resp. ± 15 VDC [connector: POWER] same as input but: [connector: SENSOR] 2.0 A max. at ± 15 VDC 1.5 A max. at + 24 VDC

¹⁾ Internal overcurrent protection by a PTC device.

²⁾ Refer to chapter «Sensor supply concepts» for details.



Calculation of complete power consumption:

$$P_{\text{tot}} = \alpha + \beta$$

whereas β depends on sensor supply concept and sensor power consumption.

Control and actuating unit (continuation)	
Sensor input Signal input voltage ADC resolution Sampling time	0-10 VDC / $R_i > 100 \text{ k}\Omega$ [connector: SENSOR] 0.23 mV 10 ms
Digital inputs ³⁾	$\pm 24 \text{ VDC max.}$ [connector: INTERFACE]
Digital outputs ³⁾ Input voltage Input current Breaking capacity	70 VDC or 70 V peak max. 0.5 ADC or 0.5 A peak max. 10 W max. [connector: INTERFACE]
Analog outputs ³⁾	0-10 VDC / 1 mA max. [connector: INTERFACE]
PFO ⁴⁾ battery pack [642 C / 642 H] Charging time Durability	2 minutes max. up to 10 years @ 25°C ambient; refer to «Durability of power fail battery» for details
Ambient temperature	0 °C to +50 °C max. (<35 °C recommended)
Pressure control accuracy	5 mV or 0.1% of setpoint, whichever is greater

³⁾ Refer to chapter «Schematics» for details.

⁴⁾ PFO = Power Failure Option. Refer to «Behavior in case of power failure» for details.

1.6.2 Valve unit

Description											
Pressure range at 20°C (unheated on delivery)											
<ul style="list-style-type: none"> • DN63...200 • DN250...400 					1 × 10E-8 mbar to 2.0 bar (abs) 1 × 10E-8 mbar to 1.2 bar (abs)						
Leak rate to outside / seat at 20°C (unheated on delivery)					1 × 10E-9 mbar ls ⁻¹						
Differential pressure on the gate											
<ul style="list-style-type: none"> • Valve closed <ul style="list-style-type: none"> - DN63...200 - DN250...400 • During closing / opening 					≤ 2.0 bar ≤ 1.2 bar ≤ 30 mbar						
Cycles until first service (unheated and under clean conditions)											
<ul style="list-style-type: none"> • Pressure control • Isolation cycles 					1'000'000 200'000						
Admissible operating temperature											
<ul style="list-style-type: none"> • Valve body • Ambient 					≤ 150°C ≤ 50°C						
Mounting position (valve seat to face chamber is recommended)											
<ul style="list-style-type: none"> • DN63...350 • DN400 					Any Horizontal only (optional in vertical position with extended closing time, fewer cycles)						
Process side materials		body / plate			Stainless steel: 304 (1.4301)						
		other parts			Stainless steel: 301 (1.4310), 304 (1.4301), 420 (1.4034), 420D (1.4037), 430 (1.4016)						
Seals		plate			FKM (e.g. Viton®)						
		rotary feed through			FKM (e.g. Viton®)						
		bonnet			FKM (e.g. Viton®) (DN63...200 vulcanized)						
Operating time (s) for:		DN 63	DN 80	DN 100	DN 160	DN 200	DN 250	DN 320	DN 350	DN 400	
		2½"	3"	4"	6"	8"	10"	12"	14"	16"	
Open / close		4	4	6	6	6	10	10	10	10	
Pressure control (throttling)		3	3	3	5	5	9	9	9	9	
Min. controllable conductance (ls ⁻¹) [N ₂ molecular flow]		0.65	0.8	1	1.6	2	2.5	3.2	3.5	4	
Max. Conductance (ls ⁻¹) [N ₂ molecular flow]		440	800	1700	5000	12000	22000	30000	40000	50000	
Weight (approx.)		kg	14	14	17	28	34	62	112	120	155
		lbs	31	31	37	62	75	136	246	264	340
Valve position indication					Visual (mechanical and on controller)						
Dimensions					Refer to dimensional drawing of specific valve ordering number (available on request)						

2 Safety

2.1 Compulsory reading material

Read this chapter prior to performing any work with or on the product. It contains important information that is significant for your own personal safety. This chapter must have been read and understood by all persons who perform any kind of work with or on the product during any stage of its serviceable life.

	NOTICE
	<p>Lack of knowledge Failing to read this manual may result in property damage. Firstly, read manual.</p>





These Installation, Operating & Maintenance Instructions are an integral part of a comprehensive documentation belonging to a complete technical system. They must be stored together with the other documentation and accessible for anybody who is authorized to work with the system at any time.

2.2 Danger levels



	⚠ DANGER
	<p>High risk Indicates a hazardous situation which, if not avoided, will result in death or serious injury.</p>

	⚠ WARNING
	<p>Medium risk Indicates a hazardous situation which, if not avoided, could result in death or serious injury.</p>

	⚠ CAUTION
	<p>Low risk Indicates a hazardous situation which, if not avoided, may result in minor or moderate injury.</p>

	NOTICE
	<p>Command Indicates a hazardous situation which, if not avoided, may result in property damage.</p>

2.3 Personnel qualifications

	 WARNING
	Unqualified personnel Inappropriate handling may cause serious injury or property damage. Only qualified personnel are allowed to carry out the described work.

2.4 Safety labels

Label	Part No.	Location on valve
	T-9001-156	On protective foil covering of valve opening

3 Design and Function

3.1 Design

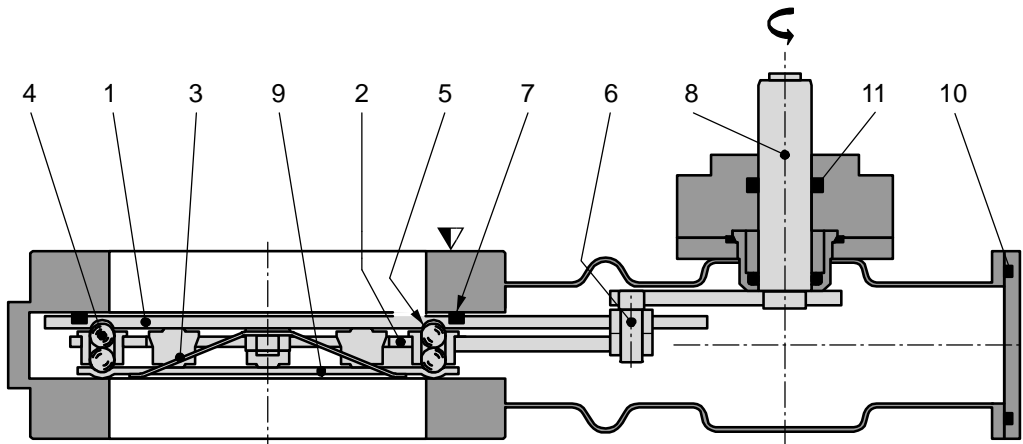

- | | |
|-----------------|------------------------------|
| 1 Valve gate | 7 Gate seal |
| 2 Ball guidance | 8 Actuator shaft |
| 3 Leaf spring | 9 Counter plate |
| 4 Ball pairs | 10 Bonnet seal |
| 5 Detents | 11 Rotary feed through seals |
| 6 Crank bolt | |

3.2 Function

The valve gate (1) acts as a throttling element and varies the conductance of the valve opening. Actuation is performed with a stepper motor and controller. The stepper motor/controller version ensures accurate pressure control due to exact gate positioning. For leak tight closing the VATLOCK principle is applied. For details refer to VAT catalog.

3.2.1 Pressure control system overview and function

Vacuum pressures are always absolute pressures unless explicitly specified as pressure differences.

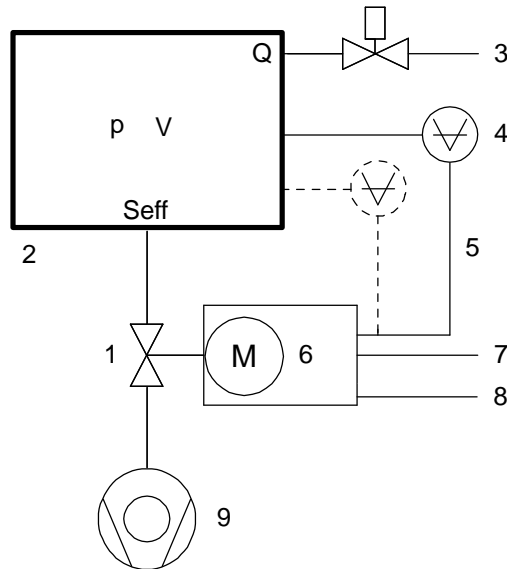

- 1 Valve
- 2 Process chamber
- 3 Gas inlet
- 4 Pressure sensor(s)
- 5 Sensor cable
- 6 Controller and actuator
- 7 Cable to remote control unit
- 8 Cable to power supply
- 9 HV Pump

$$S_{\text{eff}} = Q / p$$

S_{eff} effective pump speed (ls^{-1})

Q Gas flow (mbar)

p Pressure (mbar)

or units used in USA

$$S_{\text{eff}} = 12.7 \cdot Q / p$$

S_{eff} effective pump speed (ls^{-1})

Q Gas flow (sccm)

p Pressure (mTorr)

Example: Downstream control

3.2.1.1 Way of operation

The controller compares the actual pressure in the process chamber given by the pressure sensor with the preset pressure. The controller uses the difference between actual and set pressure to calculate the correct position of the control valve. The controller drives the control valve into the correct position and the actual pressure again equals the set pressure.

This control operation is performed continuously. Pressure changes in the process chamber due to leaks, desorption, and gas flow, reaction products, variations in pumping speed etc. are always corrected at once.

3.2.1.2 Pressure control

In a vacuum system which is pumped and into which gas is admitted at the same time, the pressure can be controlled in two ways:

1. Downstream control (standard):
The pressure is controlled by changing the conductance of a control valve between pump and process chamber. This changes the effective pumping speed at the process chamber. Pressure and gas flow can be independently controlled over a wide range.
2. Upstream control:
The pressure is controlled by changing the gas flow into the process chamber, while the pumping speed remains constant.

3.2.1.3 Adaptive controller (standard)

A controller adapting itself to changes in pressure, gas flow and pumping system without any manual adjustments. This allows for a completely automatic operation of the system.

3.2.2 Principle of a pressure control system

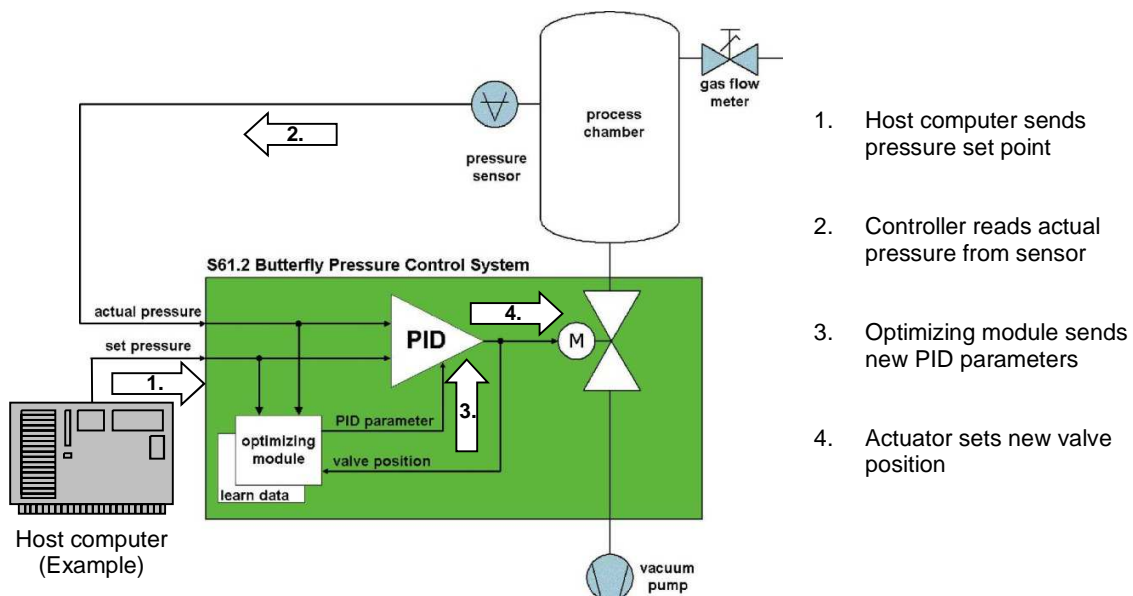

4 Installation

	⚠ WARNING
	<p>Unqualified personnel Inappropriate handling may cause serious injury or property damage. Only qualified personnel are allowed to carry out the described work.</p>

4.1 Unpacking

	NOTICE
	<p>Physical overstraining at controller Inappropriate handling with the valve may cause in damage of controller. Do not place the valve on the controller.</p>

	⚠ CAUTION
	<p>Valve is a heavy component Physical overstraining. Use a crane to lift valves DN 200 (8") and larger.</p>



- Make sure that the supplied products are in accordance with your order.
- Inspect the quality of the supplied products visually. If it does not meet your requirements, please contact VAT immediately.
- Store the original packaging material. It may be useful if products must be returned to VAT.

1. Open the transport case and remove inside packing material as far as necessary.
2. Attach lifting device for valves DN 200 (8") and larger. For attachment refer to dimensional drawing of valve.
3. Lift the valve carefully and place it on a clean place.



Do not remove protective foils from valve opening

4.2 Installation into the system

	⚠ WARNING
	<p>Valve opening Risk of serious injury. Human body parts must be kept out of the valve opening and away from moving parts. Do not connect the controller to power before the valve is installed complete into the system.</p>

	NOTICE
	<p>Sealing surfaces Sealing surfaces of valve and vacuum system could be damage in case of incorrect handling. Only qualified personal are allowed to install the valve into the vacuum system.</p>

	NOTICE
	<p>Wrong connection Wrong connection may result in damage of controller or power supply. Connect all cables exactly as shown in the following descriptions and schematics.</p>

	NOTICE
	<p>Burned connector pins (spark) Connector pins or electronic parts could damage, if plugged and unplugged under power. Do not plug or unplug connectors under power.</p>

	NOTICE
	<p>Contamination Gate and other parts of the valve must be protected from contamination. Always wear clean room gloves when handling the valve.</p>

Mount valve to a clean system only.

4.2.1 Installation space condition



Install the valve with integrated controller with space for dismantling and air circulation as shown in figure below. (sample picture)

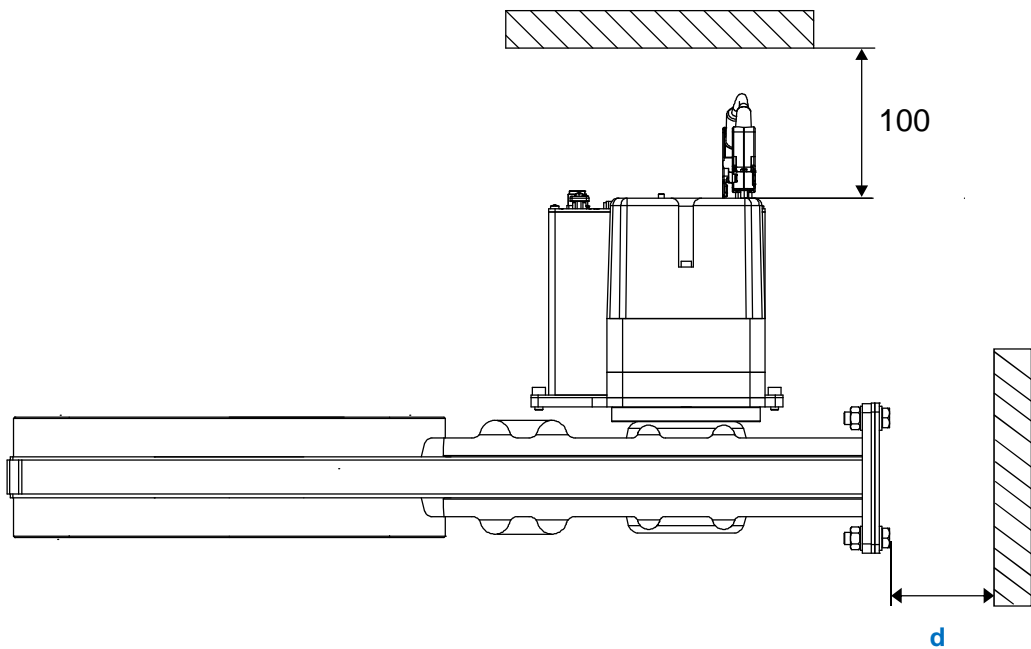

Overview table: DN to required distance (d) for maintenance.

DN	63	80 / 100	160	200	250	320 / 350	400
d	180	220	300	350	450	550	600

4.2.2 Connection overview

System:

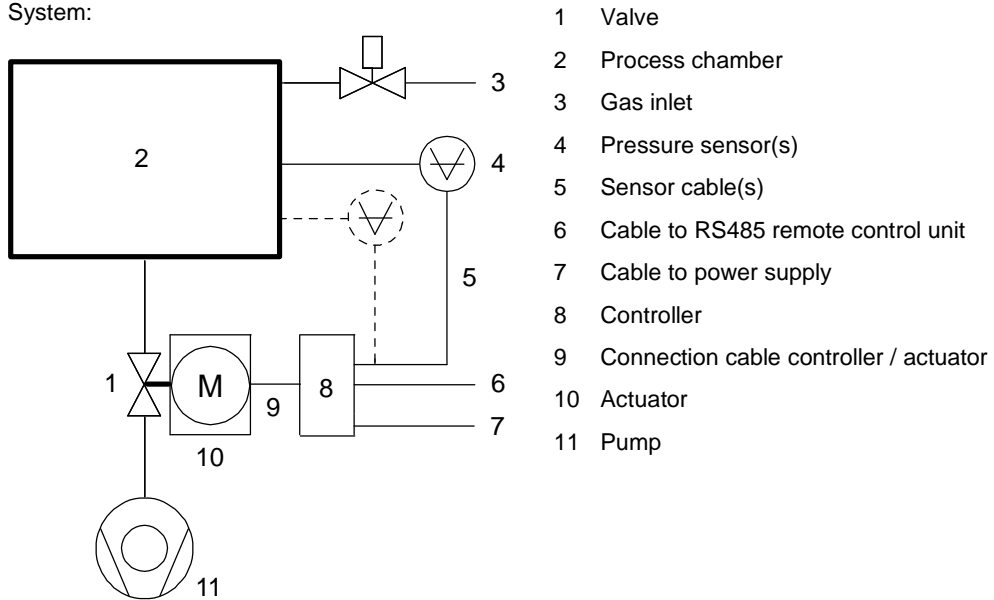

- 1 Valve
- 2 Process chamber
- 3 Gas inlet
- 4 Pressure sensor(s)
- 5 Sensor cable(s)
- 6 Cable to RS485 remote control unit
- 7 Cable to power supply
- 8 Controller
- 9 Connection cable controller / actuator
- 10 Actuator
- 11 Pump

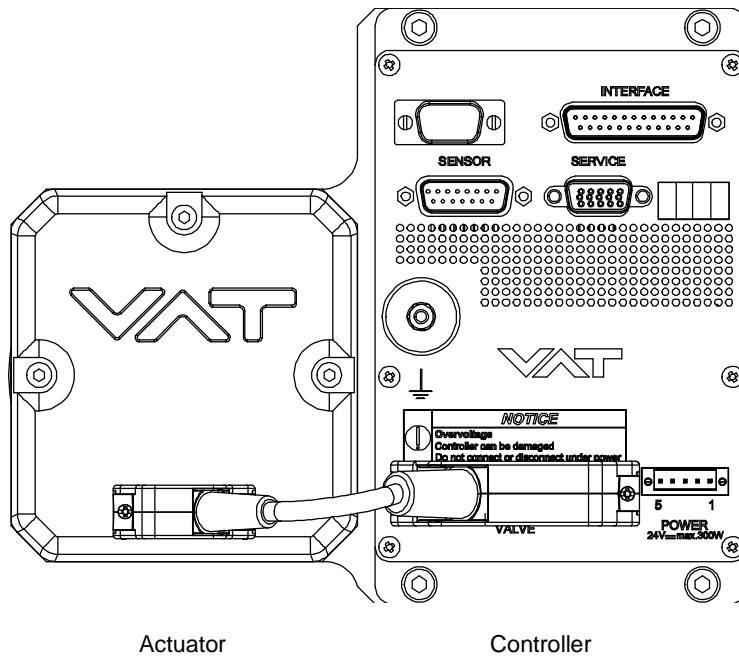

Actuator

Controller

4.2.3 Installation procedure

1. Install valve [1] into the vacuum system, with valve seat side to process chamber. The valve seat side is indicated by the symbol "Δ" on the valve flange.



- Do not tighten the flange screws stronger than indicated under «Tightening torque».
- Do not admit higher forces to the valve than indicated under «Admissible forces».
- Make sure that enough space is kept free to do preventive maintenance work. The required space is indicated on the dimensional drawing.

2. Install the ground connection cable at controller. Refer to «Electrical connection»
3. Install connection cable between actuator (connector) and controller (connector: VALVE)
4. Install sensor(s) [4] according to the recommendations of the sensor manufacturer and directives given under «Requirements to sensor connection».
5. Connect pressure sensor cable [5] to sensor(s) and then to valve (connector: SENSOR). Refer to chapter «Electrical connection» for correct wiring.



Input for second sensor is available on 642 H - version only.

6. Connect valve to RS485 Interface [6] (RS485 connector). Refer to «Function and Wiring» for correct wiring.
7. Connect power supply [7] to valve (connector: POWER). Refer to chapter «Electrical connection» for correct wiring.



To provide power to the valve motor pins 2 and 3 must be bridged, otherwise motor interlock is active and the valve enters the safety mode and is not operative. Refer also to «Safety mode».

8. This valve may optionally be equipped with a heating device. Connect VAT heating device according to manual of respective heating device.
9. Perform «Setup procedure» to prepare valve for operation.



Without performing the setup procedure the valve will not be able to do pressure control.

4.3 Tightening torque

4.3.1 Mounting of CF-F flanges

Tightening torques for CF-F flange connections depends on the type of seal which is used. Follow recommendations of seal manufacturer.



The torque values below are dependent on many factors, such as materials involved, surface quality, surface treatment, and lubrication.

The torques below are valid if immersion depth of the mounting screws is at least once the thread diameter (min. 1d), and the friction coefficient of the screw-flange connection ($\mu_{total} = (\mu_{screw\ thread-helicoil} + \mu_{under\ screw\ head})/2$) is bigger than 0.12. Lower friction coefficients may damage the valve, as the resulting preload force gets too high. Therefore for other friction coefficients the torque needs to be adapted. Please review design guidelines for Helicoil-Screw connections and make sure that screws in use are capable to withstand applied torques, are appropriate for the application and are not too long. Too long screws may damage the valve, the immersion depth should not exceed (hole depth – 1 mm).

Tighten mounting screws of the flanges uniformly in crosswise order. Observe the maximum torque levels in the following tables.

4.3.2 Mounting with centering rings

DN		max. torque (Nm)			max. torque (lbs . ft)			Max. hole depth [d] (mm)		
mm	inch	ISO-F	JIS	ASA-LP	ISO-F	JIS	ASA-LP	ISO-F	JIS	ASA-LP
63	2 1/2	8 – 10	8 – 10	8 – 10	6 – 8	6 – 8	6 – 8	13	13	15
80	3	8 – 10	8 – 10	8 – 10	6 – 8	6 – 8	6 – 8	13	13	15
100	4	8 – 10	8 – 10	8 – 10	6 – 8	6 – 8	6 – 8	13	13	15
160	6	13 – 15	13 – 15	20 - 30	9 - 11	9 - 11	15 – 22	14	14	15
200	8	13 – 15	13 – 15	20 - 30	9 - 11	9 - 11	15 – 22	16	16	20
250	10	17 – 20	17 – 20	40 – 60	13 – 15	13–15	30 – 44	16	16	20
320	12	17 - 20	17 – 20	40 - 60	13 – 15	13–15	30 - 44	16	16	20
350	12	17 - 20	17 – 20	40 - 60	13 – 15	13–15	30 - 44	16	16	20
400	16	17 – 20	30 – 35	55 – 80	13 – 15	22 – 26	41 – 59	25	25	NA

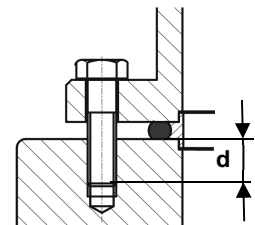

Refer to «Spare parts / Accessories» for centering rings ordering numbers.

4.3.3 Mounting with O-ring in grooves

DN		max. torque t (Nm)			max. torque (lbs . ft)			Max. hole depth [d] (mm)		
mm	inch	ISO-F	JIS	ASA-LP	ISO-F	JIS	ASA-LP	ISO-F	JIS	ASA-LP
63	4	N/A	N/A	N/A	N/A	N/A	N/A	13	13	15
80	4	N/A	N/A	N/A	N/A	N/A	N/A	13	13	15
100	4	N/A	N/A	N/A	N/A	N/A	N/A	13	13	15
160	6	N/A	N/A	N/A	N/A	N/A	N/A	14	14	15
200	8	N/A	N/A	N/A	N/A	N/A	N/A	16	16	20
250	10	N/A	N/A	N/A	N/A	N/A	N/A	16	16	20
320	12	N/A	N/A	N/A	N/A	N/A <td N/A	16	16	20	
350	12	NA	N/A	N/A	N/A	N/A	N/A	16	16	20
400	16	NA	N/A	N/A	N/A	N/A	N/A	25	25	N/A

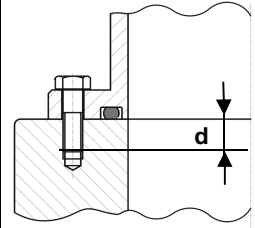

4.4 Admissible forces

	NOTICE
	<p>Force at flange and valve body</p> <p>Forces from evacuating the system, from the weight of other components, and from baking can lead to deformation and malfunctioning of the valve.</p> <p>Do not higher force the valve body as specified.</p>



The following forces are admissible.

DN (nom. I.D.)		Axial traction or pressure force «F _A »		Bending moment «M»	
mm	inch	N	lbf	Nm	lbf · ft
63	2½	1960	440	78	58
80	3	1960	440	78	58
100	4	2450	560	98	72
160	6	2940	660	147	108
200	8	2940	660	147	108
250	10	3430	770	196	145
320	12	3920	880	294	217
350	14	3920	880	294	217
400	16	7840	1760	980	722

In case of both kind of forces are occurring («F_A» und «M»), the above shown values are invalid. Please contact VAT in this case.

4.4.1 Requirements to sensor connection



To achieve fast and accurate pressure control a fast sensor response is required. Sensor response time: $< 50\text{ms}$. The sensor is normally connected to the chamber by a pipe. To maintain that the response time is not degraded by this connection it needs to meet the following requirements:

- Inner diameter of connection pipe: $\geq 10\text{ mm}$
- Length of connection pipe: $\leq 300\text{ mm}$

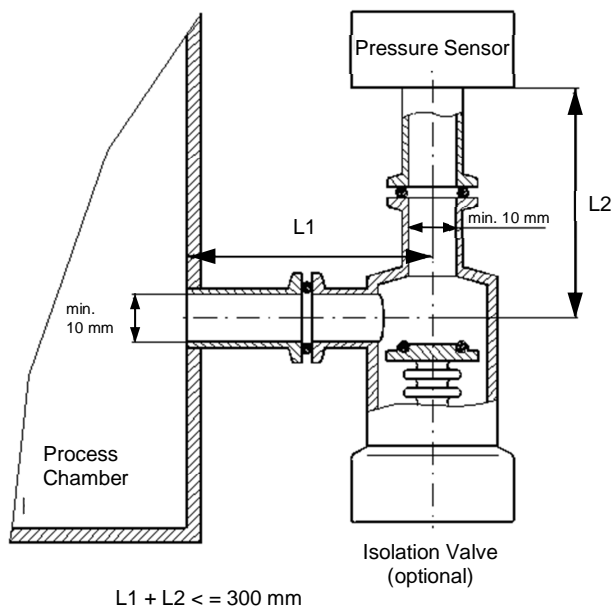
These conductance guidelines must include all valves and limiting orifices that may also be present. Make also sure that there is no obstruction in front of sensor connection port inside the chamber. The sensor should also be mounted free of mechanical shock and vibration. Dynamic stray magnetic fields may introduce noise to sensor output and should be avoided or shielded.



4.5 Electrical connection

	NOTICE
	<p>Wrong connection</p> <p>Wrong connection may result in damage of controller or power supply. Connect all cables exactly as shown in the following descriptions and schematics.</p>
	NOTICE
	<p>Burned connector pins (spark)</p> <p>Connector pins or electronic parts could damage, if plugged and unplugged under power. Do not plug or unplug connectors under power.</p>

4.5.1 Ground connection

Recommendation for ground strap between controller ground and system chassis.

Material	L (Length max.)	B1 (min.)	B2 (min.)	d1 (∅)	d2 (∅)
copper tinned	200 mm	25 mm	25 mm	4.5 mm	customized

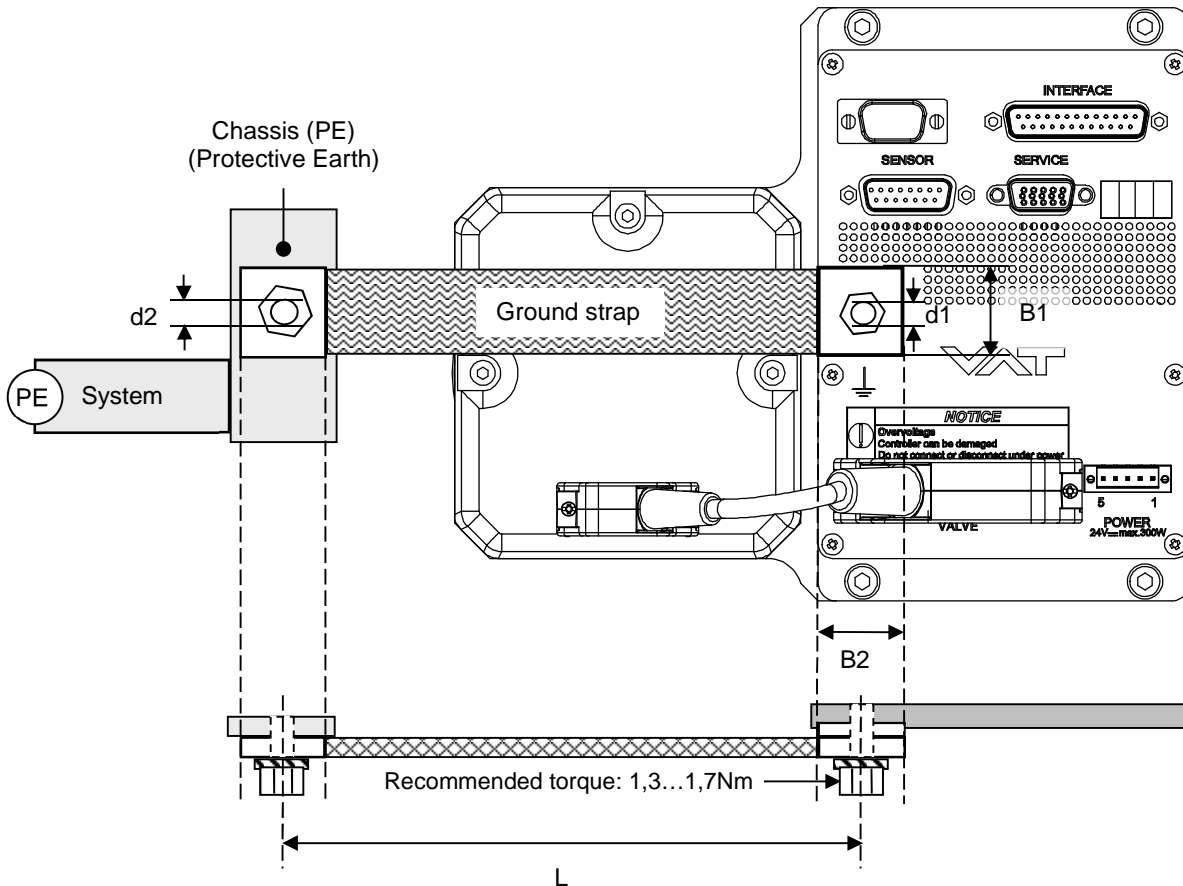

- Connection plates of ground strap must be total plane for a good electrical contact!
- The connection point at chassis (FE) must be blank metal (not coated). It is also possible to connect the ground strap at system chamber if it is well connected to PE.
- Avoid low chassis cross section to the system PE connection. (min. same cross section as ground strap)

4.5.2 Sensor supply concepts

Those valves offer 4 alternative concepts to supply the sensor(s) with power. This depends on the sensor type and valve version that is used.

Concepts:

- External +24 VDC supplied to POWER connector is feedthrough to SENSOR connector to supply 24 VDC sensors. Refer to chapter «Power and sensor connection (+24 VDC sensors)» for schematic and correct wiring.
 - External +24 VDC power to supply +24 VDC sensors.
- External +24 VDC supplied to POWER connector is converted into ± 15 VDC by the valve internal SPS and supplied to SENSOR connector to supply ± 15 VDC sensors. Refer to chapter «Power and sensor connection (± 15 VDC sensors) with opt. SPS module» for schematic and correct wiring.
 - External ± 15 VDC power to supply ± 15 VDC sensors without SPS module





The SPS module can be retrofitted. Refer to chapter «Retrofit / replacement procedure» for instruction.

4.5.3 Power and sensor connection (+24 VDC sensors)

[642 G / 642 H versions recommended]

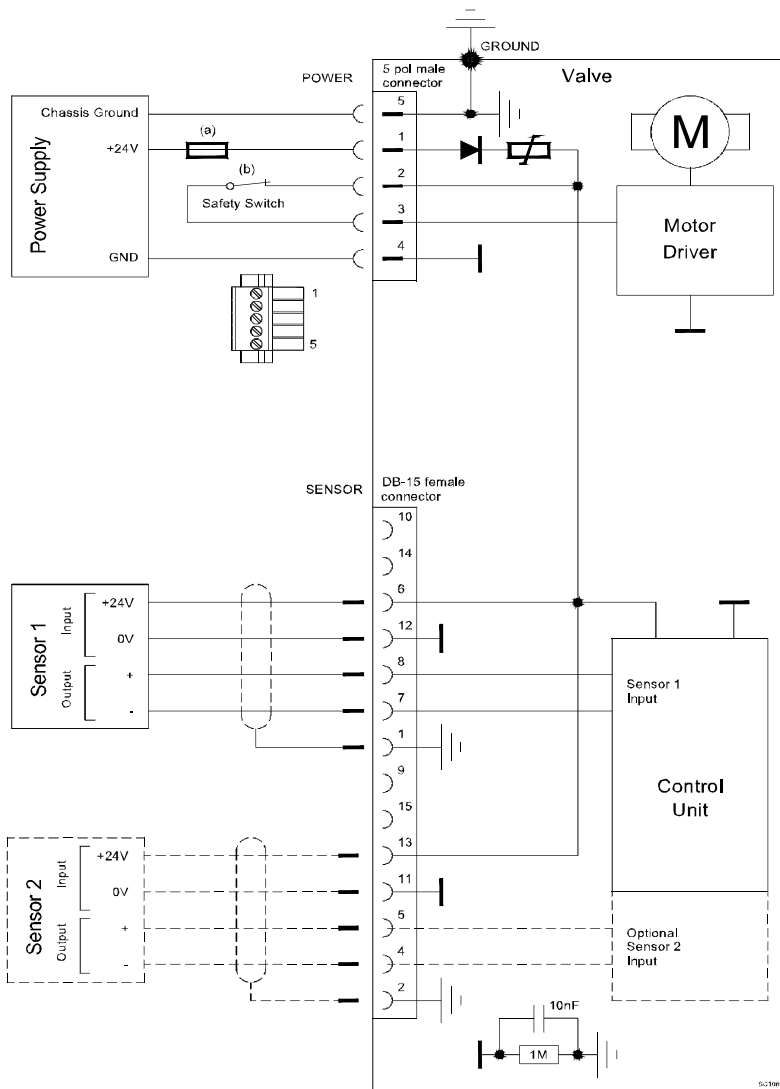
4.5.3.1 Sensor power wiring via controller





 Pins 2 and 3 must be bridged for operation. An optional switch would allow for motor interlock to prevent valve from moving.

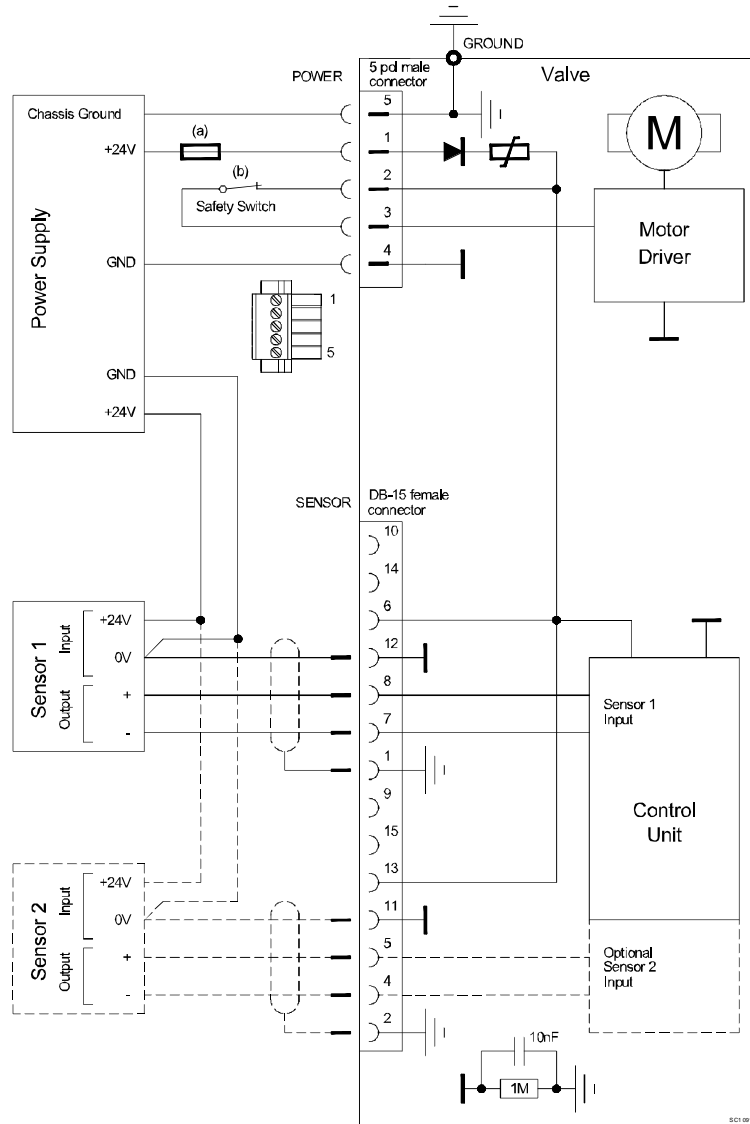

- **VAT fuse recommendation: (a) 5AF, (b) min. 3A**
- Use shielded sensor cable(s). Keep cable as short as possible, but locate it away from noise sources.
- Connect Power supply (+24 / GND) at power 5 pol. male connector and Sensors (+24V / 0V / + / -) at DB-15 female sensor connector exactly as shown in the drawing above!

4.5.3.2 Sensor power wiring external



 Pins 2 and 3 must be bridged for operation. An optional switch would allow for motor interlock to prevent valve from moving.



- **VAT fuse recommendation: (a) 5AF, (b) min. 3A**
- Use shielded sensor cable(s). Keep cable as short as possible, but locate it away from noise sources.
- Connect Power supply (+24 / GND) at power 5 pol. male connector and Sensors (0V / + / -) at DB-15 female sensor connector exactly as shown in the drawing above!

4.5.4 Power (+24 VDC) and sensor connection (± 15 VDC sensors) with opt. SPS module

[642 A / 642 C versions only]

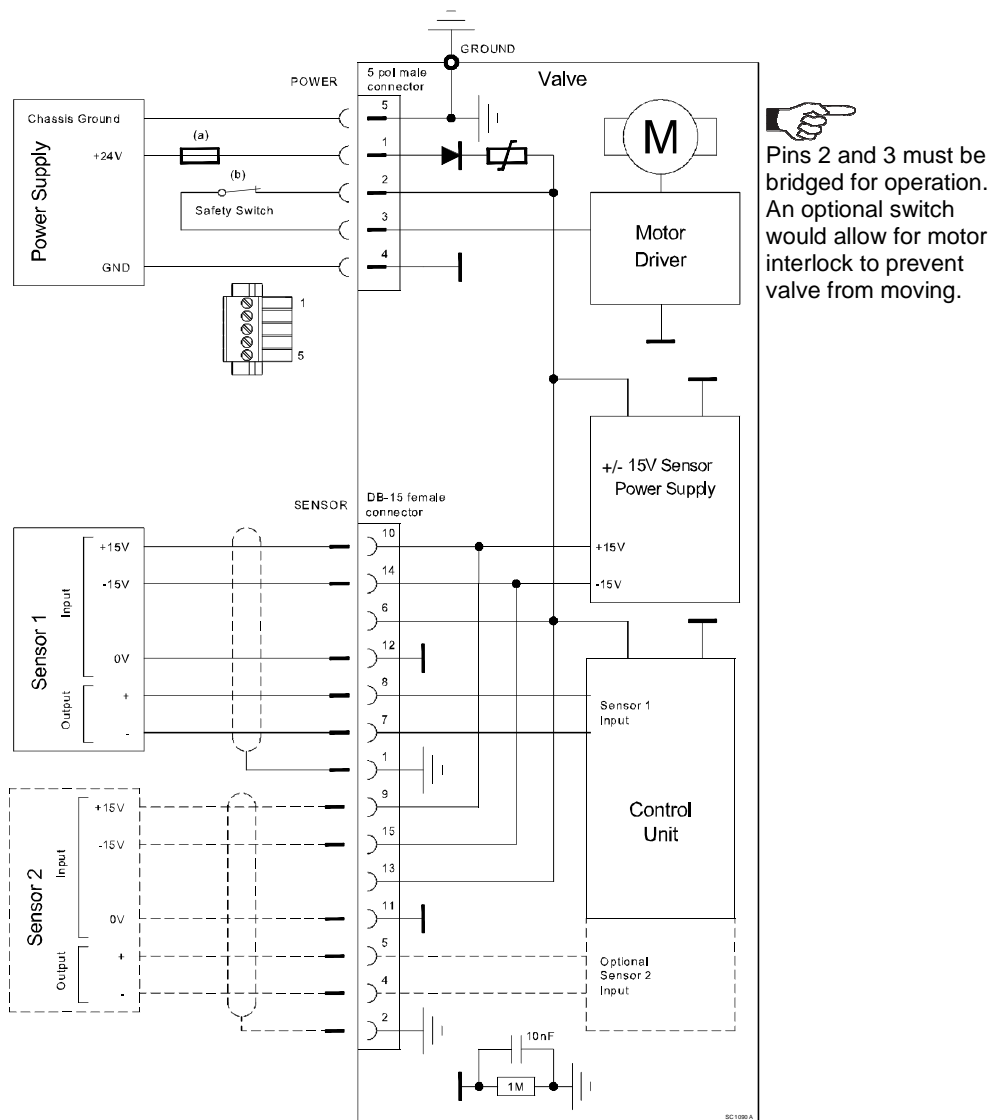

- **VAT fuse recommendation: (a) 5AF, (b) min. 3A**
- Use shielded sensor cable(s). Keep cable as short as possible, but locate it away from noise sources.
- Connect Power supply (+24 / GND) at power 5 pol. male connector and Sensors (0V / + / -) at DB-15 female sensor connector exactly as shown in the drawing above!

4.5.4.1 External sensor power wiring without SPS module

[642 G / 642 H versions only]

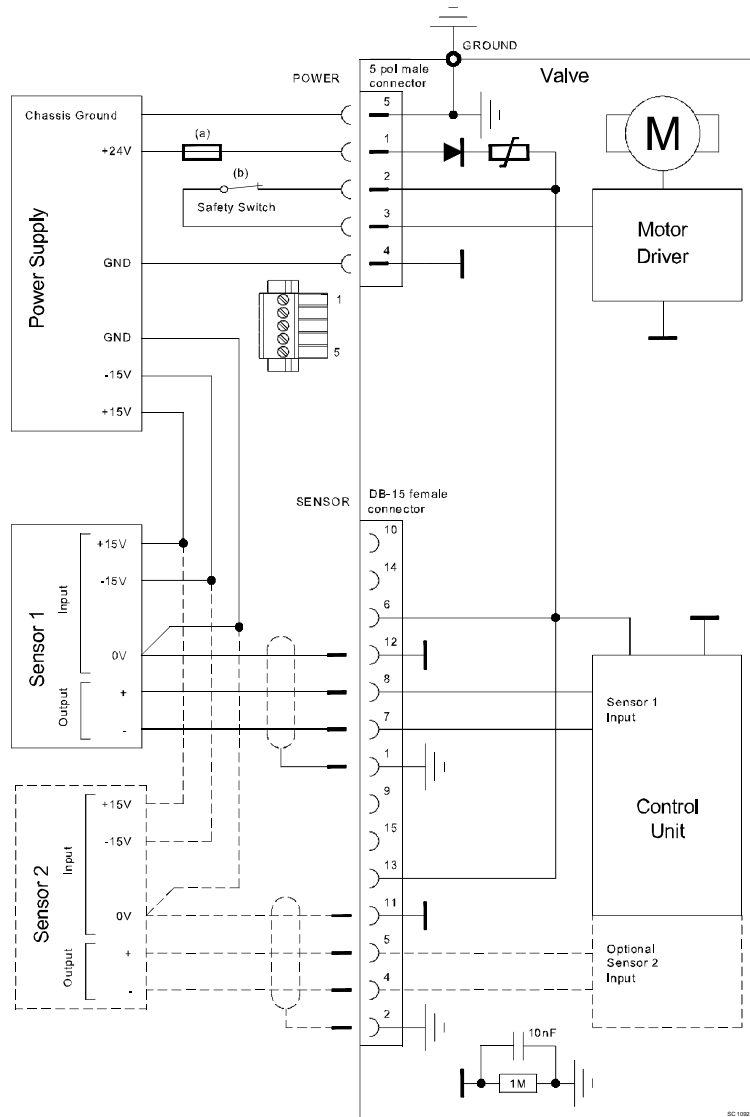

Pins 2 and 3 must be bridged for operation. An optional switch would allow for motor interlock to prevent valve from moving.



- **VAT fuse recommendation: (a) 5AF, (b) min. 3A**
- Use shielded sensor cable(s). Keep cable as short as possible, but locate it away from noise sources.
- Connect Power supply (+24 / GND) at power 5 pol. male connector and Sensors (0V / + / -) at DB-15 female sensor connector exactly as shown in the drawing above!

4.5.5 Service port connection

The service port (connector: SERVICE) allows to connect the valve to a RS232 port of a computer.

This requires a service cable and software from VAT.

You can use our Software (freeware) 'Control Performance Analyzer' which can be downloaded from:
<http://www.vatvalve.com/customer-service/informations-and-downloads/control-performance-analyzer>.

Alternatively the VAT Service Box2 can be connected to the service port for setup and local operation.

The service port is not galvanic isolated. Therefore we recommend using this only for setup, testing and maintenance and not for permanent control.

Refer also to chapter: «Local Operation» for details and to chapter «Spare parts / Accessories» for ordering numbers of service cable, software and Service Box 2.



Use only screws with 4–40 UNC thread for fastening the service port connector.

4.5.6 Function and Wiring

This interface allows for remote operation by means of a command set based on the RS485 protocol.

In addition there are 2 digital inputs and 2 digital outputs. Digital inputs may be operated either by switches or by voltage sources.



Active **digital inputs** have **higher priority than RS485** commands.

a) Configuration with switches for digital inputs:

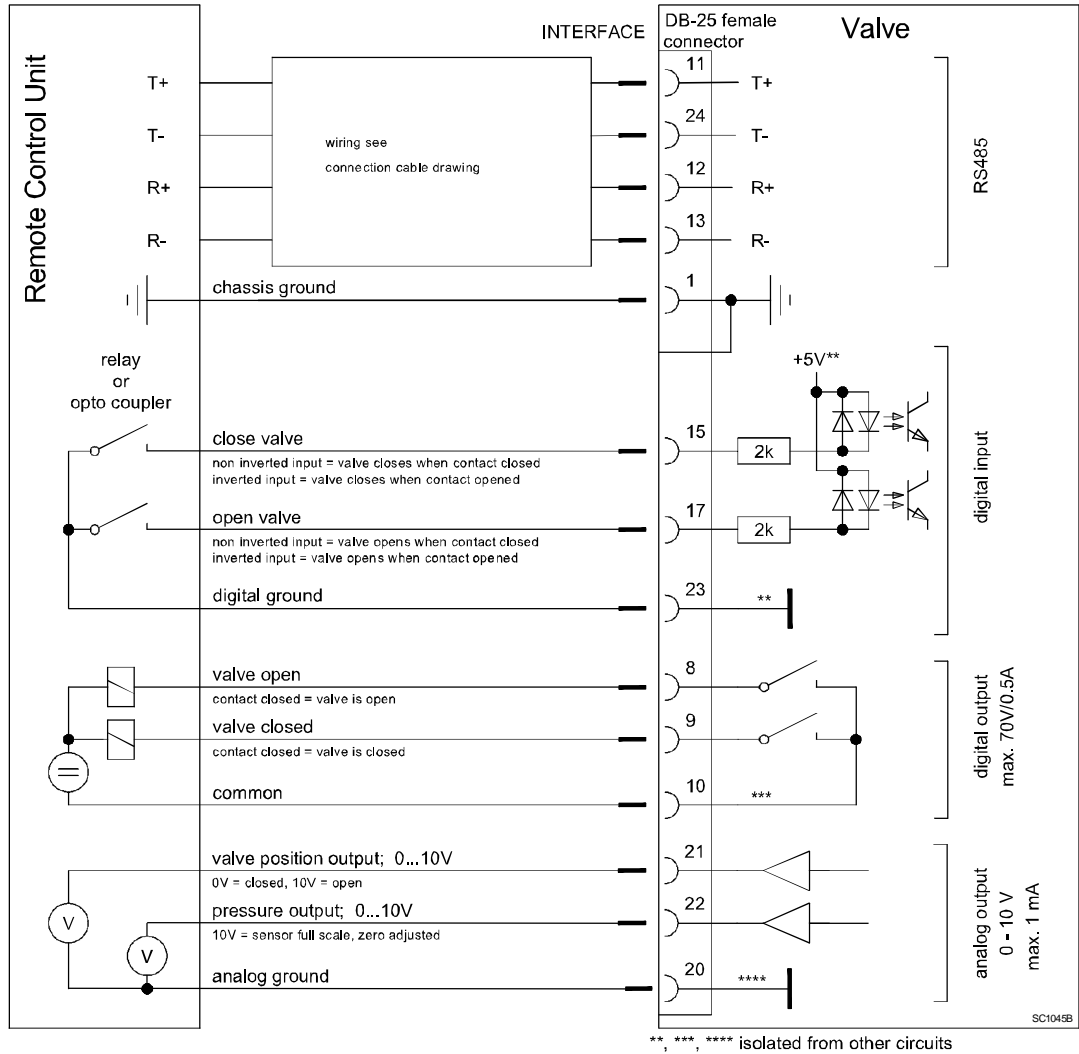

Do not connect other pins than indicated in the schematics above!
Use only screws with 4-40UNC thread for fastening the DB-25 connector!

b) Configuration with voltage source for digital inputs:

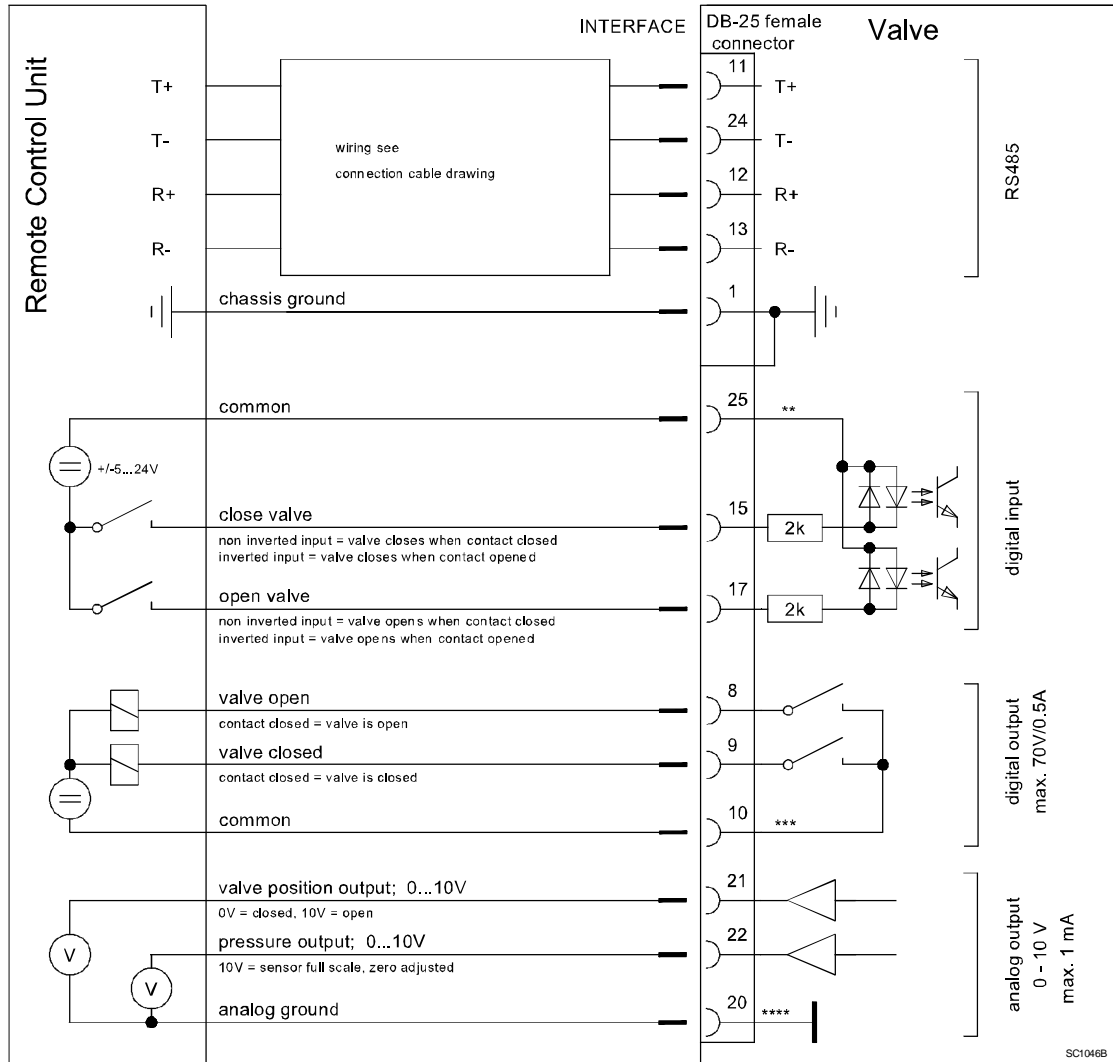

Do not connect other pins than indicated in the schematics above!
Use only screws with 4-40UNC thread for fastening the DB-25 connector!

4.5.7 Digital inputs

Pin	Function	Signal type	Description	Priority
15	CLOSE VALVE	Digital input ¹⁾	<p>This function will close the valve. Valve will be in interlock mode as long as function is activated. After deactivation of function it will remain effective until</p> <ul style="list-style-type: none"> - OPEN valve digital input is active - converse RS485 control command have been received <p>The function is activated when optocoupler is 'on' in non inverted configuration. The function is activated when optocoupler is 'off' in inverted configuration.</p> <p>Configuration can be done in local operation via service port or in remote operation.</p>	1 ²⁾
17	OPEN VALVE	Digital input ¹⁾	<p>This function will open the valve. Valve will be in interlock mode as long as function is activated. After deactivation of function it will remain effective until converse RS485 control command have been received.</p> <p>The function is activated when optocoupler is 'on' in non inverted configuration. The function is activated when optocoupler is 'off' in inverted configuration.</p> <p>Configuration can be done in local operation via service port or in remote operation.</p>	2 ²⁾
23	DIGITAL GROUND	Digital ground	Ground for all digital inputs. Ground is used when digital inputs are operated by switches. Connect switches to ground. See also «Function and Wiring» configuration a).	
25	DIGITAL COMMON	Digital common	Common for all digital inputs. Common is used when digital inputs are driven by voltage sources. Connect + or – terminal of source with common (optocoupler inputs are capable of bidirectional operation). See also « Function and Wiring» configuration b).	

- 1) All digital inputs are digitally filtered. Filter delay is 50ms. This means that digital signals must be applied for at least 50ms to be effective. Refer to « Function and Wiring » for details about input circuit.
- 2) Highest priority is 1. Functions with lower priorities will not be effective as long as higher priority functions are active. These digital inputs have higher priority than all RS485 commands. RS485 commands will not be accepted while digital inputs are active.

4.5.8 RS485 network topology

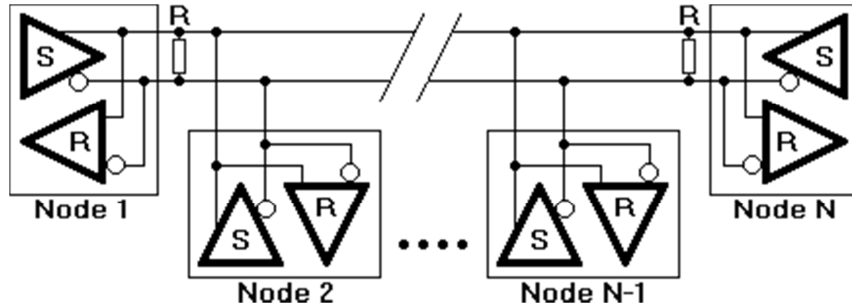

In the picture above, the general network topology of **RS485** is shown. **N nodes** are connected in a multipoint **RS485** network. A termination resistance is necessary on both ends of the line to eliminate reflections. Use **120Ω** resistors (**R**) on both ends. The **RS485** network must be designed as one line with multiple drops, not as a star.

4.5.9 Connection cable drawing

Half duplex

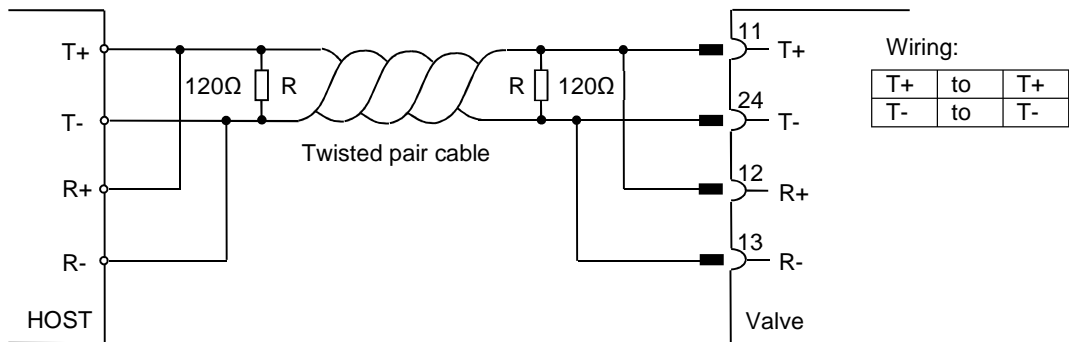

Full duplex

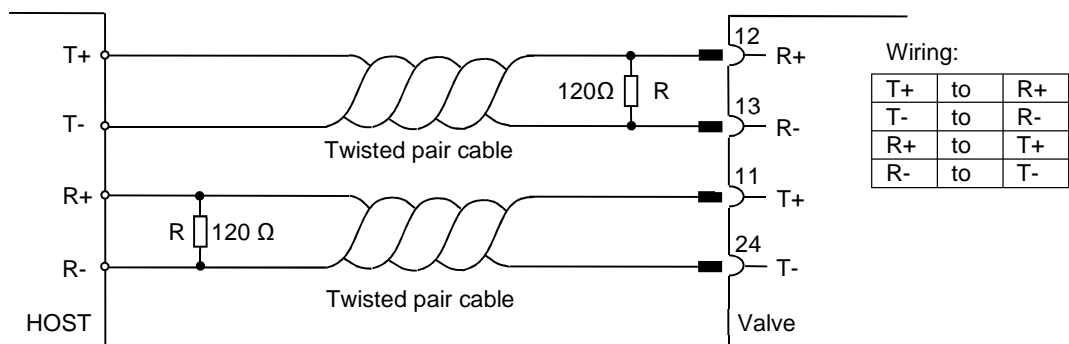

4.6 Initial operation



To enable the valve cluster for **pressure control** setup **steps 1 to 7** must be performed. In case position control is required only it's sufficient to perform steps 1 to 4.

Setup step	Description
1	POWER UP Turn on external + 24VDC power supply (and external ± 15 VDC for sensor power supply if required). Refer to chapter «Behavior during power up» for details.
2	INTERFACE CONFIGURATION RS485 Baud rate, parity, data length and number of stop bits for valve must be selected. Refer to chapter «Interface configuration» for details.
3	VALVE CONFIGURATION Basic configurations of the valve must be adapted according to application needs. Refer to chapter «Valve configuration» for details.
4	SENSOR CONFIGURATION Basic configurations of the valve must be adapted according to application needs. Refer to chapter «Sensor configuration» for details.
5	ZERO Compensation of the sensor offset voltage. Refer to chapter «ZERO» for details.
6	LEARN For adaptive pressure controller only. Determination of the vacuum system characteristic to accommodate the PID controller. Refer to chapter «LEARN adaptive» for details.
7	PRESSURE CONTROL COFIGURATION Accommodation of PID controller to the vacuum system characteristic. Refer to chapter: «Pressure Control configuration» for details.



Without «LEARN adaptive» or «Pressure Control configuration» the valve is not able to run pressure control.



For ease setup (in Local mode) of 'Interface', 'Valve', 'Sensor', 'Sensor ZERO', 'LEARN' and 'PRESSURE CONTROL COFIGURATION' it is possible to use the CPA 3.0, The free download is available on the VAT homepage: <http://www.vatvalve.com/customer-service/informations-and-downloads/control-performance-analyzer>

4.6.1 RS485 Interface configuration

Interface configuration must be adapted according to application needs. The factory default setting of the interface is shown in the tables below.

Baud rate	Data bits	Stop bits	Parity
9600	7	1	even

Address	Duplex	Digital input OPEN	Digital input CLOSE
0	full duplex	not inverted	not inverted

- Functionality of digital interlock inputs CLOSE VALVE and OPEN VALVE. These may be configured as 'not inverted', 'inverted' or 'disabled'. Default is 'not inverted'. Refer also to «Digital inputs».

- Pressure and position range for RS485 communication must be selected. Default for pressure is 0 - 1'000'000. Default for position is 0 - 100'000.

<p>Local operation: (‘Control Performance Analyzer’ or Service Box2)</p>	<p>Remote operation: (Refer to chapter «setup commands» for details)</p>
<ul style="list-style-type: none"> • With CPA, do configuration in menu ‘Interface / Setup’. 	<ol style="list-style-type: none"> 1. Send INTERFACE CONFIGURATION 1 2. Send INTERFACE CONFIGURATION 2 3. Send COMMUNICATION RANGE CONFIGURATION

4.6.2 Valve configuration

Basic valve configuration must be adapted according to application needs.
Definition of valve plate position in case of:

- **After power up**, default is ‘close’.
- **Power failure**, default is ‘not defined’. Only for versions that have Power Fail Option equipped [642 . . - . . C . - or 642 H . -].
- **Network failure**, for default settings refer to individual product data sheet.

Local operation: ('Control Performance Analyzer' or 'Service Box 2')	Remote operation: (Refer to chapter «Setup commands» for details)
With CPA: <ul style="list-style-type: none"> Do valve configuration in menu 'Valve / Setup'. With SB2: <ul style="list-style-type: none"> Do power up configuration in menu 'Setup / Valve'. Do power fail configuration in menu 'Setup / Valve'. 	1. Send VALVE CONFIGURATION

4.6.3 Sensor configuration

Basic sensor configuration must be adapted according to application needs.

- ZERO function: This may be 'disabled' or 'enabled'. Default is 'enabled'. Refer also to chapter «ZERO».
- Sensor configuration with 2 sensor version [642 K - . . .]. Refer also to chapter: «Pressure control operation with 2 sensors».

Local operation: ('Control Performance Analyzer' or 'Service Box 2')	Remote operation: (Refer to chapter «Setup commands» for details)
With CPA: <ul style="list-style-type: none"> Do sensor configuration in menu 'Sensor / Setup'. With SB2: <ul style="list-style-type: none"> Enable or disable ZERO function in menu 'Setup / Sensor'. Do 2 sensor configuration in menu 'Setup / Sensor'. 	Send SENSOR CONFIGURATION

4.6.4 ZERO

ZERO allows for the compensation of the sensor offset voltage.

When ZERO is performed the current value at the sensor input is equated to pressure zero. In case of a 2 sensor system both sensor inputs will be adjusted. A max. offset voltage of +/- 1.4 V can be compensated. The offset value can be read via local and remote operation.

Local operation: ('Control Performance Analyzer' or 'Service Box 2')	Remote operation: (Refer to chapter «Control commands» resp. «Setup commands» for details)
With CPA: <ul style="list-style-type: none"> Do the ZERO in menu 'Sensor / Zero'. With SB2: <ul style="list-style-type: none"> Go to menu 'Zero / ZERO' and follow instructions. 	1. Send OPEN VALVE 2. Wait until process chamber is evacuated and sensor signal is not shifting anymore. 3. Send ZERO



- Do not perform ZERO as long as pressure gauge voltage is shifting otherwise incorrect pressure reading is the result. Refer to manual of sensor manufacturer for

warm up time.

- Do not perform ZERO, if the base pressure of your vacuum system is higher than 1‰ of sensor full scale. We recommend disabling ZERO function in this case; refer to «Valve and sensor configuration» of the setup procedure. Otherwise incorrect pressure reading is the result.

4.6.5 LEARN (adaptive)

LEARN adapts the PID controller of the valve to the vacuum system and its operating conditions. LEARN must be executed only once during system setup. The LEARN routine determines the characteristic of the vacuum system. Based on this, the PID controller is able to run fast and accurate pressure control cycles.

This characteristic depends on various parameters such as chamber volume, conductance and flow regime. Therefore it must be performed with a specific gas flow according to instruction below. The result of LEARN is a pressure versus valve position data table. This table is used to adapt the PID parameters. The data table is stored in the device memory which is power fail save. The data table can be up-/downloaded via 'Control Performance Analyzer' software or remote interface. Due to encoding the data may not be interpreted directly.

By an OPEN VALVE, CLOSE VALVE, POSITION CONTROL or PRESSURE CONTROL command the routine will be interrupted.

<p>Local operation: (‘Control Performance Analyzer’ or ‘Service Box 2’)</p>	<p>Remote operation: (Refer to chapter «Control commands» resp. «Setup commands» for details)</p>
<p>With CPA:</p> <ul style="list-style-type: none"> • Do the LEARN in menu ‘Pressure Control / Learn’. <p>With SB2:</p> <ul style="list-style-type: none"> • Go to ‘LOCAL / LEARN’ and follow instructions. 	<ol style="list-style-type: none"> 1. Send OPEN VALVE 2. Set specific gas flow according to calculation below and wait until flow is stable. LEARN does not need to be performed with the process gas. Instead N₂ or Ar may be used.
<p>Gasflow calculation according to recommendation below is done automatically based on inputs.</p>	<ol style="list-style-type: none"> 3. Send LEARN with pressure limit set to p_{max} (max. pressure to control during process)



Sensor signal must not shift during LEARN. Wait until sensor signal is stable before LEARN is performed. Learn may take several minutes. Do not interrupt the routine as a single full run is required to ensure fast and accurate pressure control. The PID controller covers 5% to 5000% of the gas flow which was used for learn.

Gasflow calculation for LEARN:



Do not apply a different gasflow for learn than determined below. Otherwise pressure control performance may be insufficient. Required pressure / flow regime must be known to calculate the most suitable learn gas flow for a specific application.

- At first it is necessary to find out about the required control range respectively its conductance values. Each working point (pressure / flow) must be calculated with one following formulas. Choose the applicable formula depending on units you are familiar with.

$$C_{WP} = \frac{1000 \cdot q_{WP}}{p_{WP}}$$

C_{WP} required conductance of working point [l/s]
 q_{WP} **gasflow** of working point [**Pa m³/s**]
 p_{WP} **pressure** of working point [**Pa**]

$$C_{WP} = \frac{q_{WP}}{p_{WP}}$$

C_{WP} required conductance of working point [l/s]
 q_{WP} **gasflow** of working point [**mbar l/s**]
 p_{WP} **pressure** of working point [**mbar**]

$$C_{WP} = \frac{q_{WP}}{78.7 \cdot p_{WP}}$$

C_{WP} required conductance of working point [l/s]
 q_{WP} **gasflow** of working point [**sccm**]
 p_{WP} **pressure** of working point [**Torr**]

- Out of these calculated conductance values choose the lowest.

$$C_R = \min(C_{WP1}, C_{WP2}, \dots, C_{WPn})$$

C_R required lower conductance [l/s]
 C_{WPx} required conductance of working points [l/s]



To make sure that the valve is capable to control the most extreme working point verify that $C_R \geq C_{min}$ of the valve (refer to «Technical data»).

- Calculate gasflow for learn. Choose the applicable formula depending on units you are familiar with.

$$q_L = \frac{p_{SFS} \cdot C_{min}}{1100}$$

q_L gasflow for learn [**Pa m³/s**]
 p_{SFS} sensor full scale pressure [**Pa**]
 C_{min} min. controllable conductance of valve [l/s], (refer to «Technical data»)

$$q_L = \frac{p_{SFS} \cdot C_{min}}{1.1}$$

q_L gasflow for learn [**mbar l/s**]
 p_{SFS} sensor full scale pressure [**mbar**]
 C_{min} min. controllable conductance of valve [l/s], (refer to «Technical data»)

$$q_L = 71 \cdot p_{SFS} \cdot C_{min}$$

q_L gasflow for learn [**sccm**]
 p_{SFS} sensor full scale pressure [**Torr**]
 C_{min} min. controllable conductance of valve [l/s], (refer to «Technical data»)

4.6.6 Pressure control configuration

Select the configuration what your application needs.

System Configuration	Constant gas flow available		Constant gas flow not available
	Tv* <= 500 sec	Tv* > 500 sec	
<p>Downstream</p>	<p>Adaptive pressure controller (Refer to chapter: Pressure controller)</p>	<p>Fixed pressure controller (Refer to chapter: Pressure controller)</p>	
<p>Upstream</p>	<p>Fixed pressure controller (Refer to chapter: Pressure controller)</p>		
<p>Soft Pump</p>	<p>Soft Pump (Refer to chapter: Pressure controller)</p>		



Use the formula below to define the applicable pressure control algorithm.

$$Tv = \frac{p_{SFS} \cdot CV}{q_L}$$

- q_L** gasflow for learn [mbar/s]
- p_{SFS}** sensor full scale pressure [mbar]
- Tv*** Vacuum time constant [sec]
- CV** Chamber Volume [l]

4.6.6.1 Pressure controller

Configuration of three possible pressure controller.

Local operation: (‘Control View’ or ‘Control Performance Analyzer’)		Remote operation:								
1. Open CV or CPA 2. Go to «Tools» > «Terminal» and send setup command s:02 according to application needs. (possibility of adjustment see below)		Refer to chapter: «RS485 interface commands»								
	<table border="1"> <thead> <tr> <th>Command</th> <th>Acknowledgement (within 10ms after reception of command)</th> </tr> <tr> <th colspan="2">Description</th> </tr> </thead> <tbody> <tr> <td>Set s:02Z00a configure pressure controller a</td> <td></td> </tr> <tr> <td>Get i:02Z00 get the actual pressure controller a</td> <td>i:02Z00a</td> </tr> </tbody> </table>		Command	Acknowledgement (within 10ms after reception of command)	Description		Set s:02Z00a configure pressure controller a		Get i:02Z00 get the actual pressure controller a	i:02Z00a
Command	Acknowledgement (within 10ms after reception of command)									
Description										
Set s:02Z00a configure pressure controller a										
Get i:02Z00 get the actual pressure controller a	i:02Z00a									
This command selects pressure controller.										
a Pressure controller 0 = Adaptive downstream 1 = Fixed 1 2 = Fixed 2 3 = Soft pump										



For easy setup (Local operation) of ‘Pressure controller’ and ‘Pressure control parameter’ please use the VAT “Control Performance Analyzer” CPA 3.0. There is a free download on the VAT home page, refer to: <http://www.vatvalve.com/customer-service/informations-and-downloads/control-performance-analyzer>

4.6.6.2 With CPA 3.0 direct setup (standard)

Open the CPA. In menu ‘Pressure Control’ / ‘Setup’, select the ‘Pressure controller’ and do the setup for pressure control algorithm (parameter).

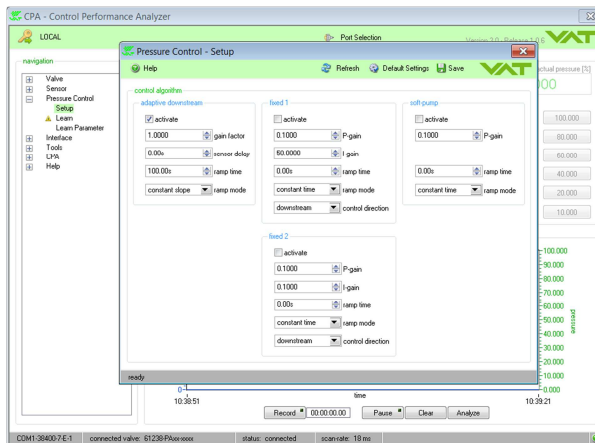

4.6.6.3 Pressure control parameter

Local operation: (‘Control Performance Analyzer’)		Remote operation:												
<ul style="list-style-type: none"> • Open CPA • Go to «Tools» > «Terminal» and send setup commands:02 according to application needs. (possibility of adjustment see below) 		<p>Refer to chapter: «RS485 interface commands»</p>												
	<table border="1"> <thead> <tr> <th></th> <th>Command</th> <th>Acknowledgement (within 10ms after reception of command)</th> </tr> <tr> <th colspan="3">Description</th> </tr> </thead> <tbody> <tr> <td>Set</td> <td>s:02abbc configure pressure control parameters</td> <td></td> </tr> <tr> <td>Get</td> <td>i:02abbc get pressure control parameters</td> <td>i:02abbc</td> </tr> </tbody> </table>			Command	Acknowledgement (within 10ms after reception of command)	Description			Set	s:02 abbc configure pressure control parameters		Get	i:02 abbc get pressure control parameters	i:02 abbc
	Command		Acknowledgement (within 10ms after reception of command)											
Description														
Set	s:02 abbc configure pressure control parameters													
Get	i:02 abbc get pressure control parameters	i:02 abbc												
<p>This command selects pressure control parameter.</p> <p>a pressure controller (one digit) see table:</p> <p>bb parameter number (two digits) see table: “Overview parameter number”</p> <p>c parameter value using data type “unsigned integer” or “floating point” (dependend on the corresponding data type)</p> <p>For details (commands etc.), see next tables.</p> <p>Remark: Each pressure control algorithm has its own parameters. That means the adjustment of a e.g. adaptive downstream parameter (e.g. Ramp Time “Adaptive downstream”) doesn’t influence one of the other Ramp time parameter of other pressure control algorithms and vice versa.</p>														

4.6.6.4 Overview parameter number

Parameter	bb Parameter number	a = A (adaptive pressure controller)	a = B (fixed 1 pressure controller)	a = C (fixed 2 pressure controller)	a = D (soft pump pressure controller)
SENSOR DELAY	00	✓	x	x	x
RAMP TIME	01	✓	✓	✓	✓
RAMP MODE	02	✓	✓	✓	✓
CONTROL DIRECTION	03	x	✓	✓	x
P-GAIN (for A = GAIN FACTOR)	04	✓	✓	✓	✓
I-GAIN	05	x	✓	✓	x

✓ existent for this pressure controller
x not used for this pressure controller

4.6.7 Pressure control algorithm



- Remote operation: Refer to chapter «RS485 interface commands»
- Local operation only:
 - With CPA direct setup, see chapter: With CPA 3.0 direct setup (standard).
 - With CPA, go to «Tools» > «Terminal» and send setup commands according to application needs. See next tables.

4.6.7.1 Adaptive control algorithm (downstream)

Parameter	Command		Request	Data Type	Values
SENSOR DELAY	Set	s:02A00c	s:02	FLOAT	c = 0.00...1.00 Default is: 0.00 s
	Get	i:02A00	i:02A00c		
RAMP TIME	Set	s:02A01c	s:02	FLOAT	c = 0.00...1'000'000.0 Default is: 0.00 s
	Get	i:02A01	i:02A01c		
RAMP MODE	Set	s:02A02c	s:02	UINT	c = 0 or 1 0 = constant time 1 = constant slope Default is: 0
	Get	i:02A02	i:02A02c		
GAIN FACTOR	Set	s:02A04c	s:02	FLOAT	c = 0.0001...7.5 Default is: 1.0
	Get	i:02A04	i:02A04c		

Explanation:

SENSOR DELAY

Sensor response time [s]

The SENSOR DELAY is a control parameter to compensate delays during the pressure detection. Pipes and orifices for sensor attachment can cause delays in response time and could impact badly the pressure control stability. By adapting this parameter to the approximate delay time stability problems can be reduced. But control response time will be slowed down by this measure.

RAMP TIME

Pressure setpoint ramp time [s]

RAMP MODE

Mode = 0 Constant Time	The RAMP TIME is dependent on the adjusted parameter ramp time and is always the same independent of the control deviation. That means the ramp time from the actual value to the setpoint value is the adjusted parameter ramp time value.
Mode = 1 Constant Slope	The RAMP TIME is dependent on the adjusted parameter ramp time and is different depending on the control deviation. The RAMP TIME is calculated corresponding to the sensor full scale value (10V). Ramp time = 10 sec.;

	ramp time slope is SFS (10V) in 10 Seconds.
--	---

In the adaptive pressure controller mode, the RAMP TIME parameter also can be a value to minimize over- / undershooting. The ramp could be used to harmonize the adaptive control algorithm.

GAIN FACTOR

The GAIN FACOTR is a control parameter to adapt the performance of the pressure control algorithm. A higher gain results in faster response, higher over- / undershoot of pressure. A lower gain results in slower response, lower over- / undershoot of pressure.

Example:

Set SENSOR DELAY of the adaptive pressure controller to the value 0.75

Command	Pressure controller	Parameter selection variable	Parameter value (seconds)
s:02	A (a)	00 (bb)	0.75 (c)

→ s:02A000.75



To optimize adaptive control algorithm, refer to chapter «Tuning of control performance».

4.6.7.2 Fixed 1 control algorithm

Parameter	Command		Request	Data Type	Values
RAMP TIME	Set	s:02B01c	s:02	FLOAT	c = 0.00...1'000'000.0 Default is: 0.00
	Get	i:02B01	i:02B01c		
RAMP MODE	Set	s:02B02c	s:02	UINT	c = 0 or 1 0 = constant time 1 = constant slope Default is: 0
	Get	i:02B02	i:02B02c		
CONTROL DIRECTION	Set	s:02B03c	s:02	UINT	c = 0 or 1 0 = downstream 1 = upstream Default is: 0
	Get	i:02B03	i:02B03c		
P-GAIN	Set	s:02B04c	s:02	FLOAT	c = 0.001...100 Default is: 0.1
	Get	i:02B04	i:02B04c		
I-GAIN	Set	s:02B05c	s:02	FLOAT	c = 0...100.0 Default is: 0.1
	Get	i:02B05	i:02B05c		

Explanation:

RAMP TIME

Pressure setpoint ramp time [s]

RAMP MODE

Mode = 0 Constant Time	The RAMP TIME is dependent on the adjusted parameter ramp time and is always the same independent of the control deviation. That means the ramp time from the actual value to the setpoint value is the adjusted parameter ramp time value.
Mode = 1 Constant Slope	The RAMP TIME is dependent on the adjusted parameter ramp time and is different depending on the control deviation. The RAMP TIME is calculated corresponding to the sensor full scale value (10V). Ramp time = 10 sec.; ramp time slope is SFS (10V) in 10 Seconds.

CONTROL DIRECTION

The CONTROL DIRECTION defines the type of application, if the valve is mounted in downstream or upstream. Downstream means the valve is after the chamber and before the pump. Upstream, valve is mounted before chamber and pump.

P-GAIN / I-GAIN

The P-GAIN is the proportional factor of the fixed control algorithm. The I-GAIN is the integral factor.

Example:

Set RAMP MODE of the Fixed 1 pressure controller to the value 0 (fixed time)

Command	Pressure controller	Parameter selection variable	Parameter value
s:02	B (a)	02 (bb)	0 (c)

→ s:02B020



To optimize Fixed 1 control algorithm, refer to chapter «Tuning of control performance».

4.6.7.3

Fixed 2 control algorithm

Parameter	Command	Request	Data Type	Values	
RAMP TIME Pressure setpoint ramp time [s]	Set	s:02C01 c	s:02	FLOAT	c = 0.00...1'000'000.0 Default is: 0.00
	Get	i:02C01			
RAMP MODE	Set	s:02C02 c	s:02	UINT	c = 0 or 1 0 = constant time 1 = constant slope Default is: 0
	Get	i:02C02			
CONTROL DIRECTION	Set	s:02C03 c	s:02	UINT	c = 0 or 1 0 = downstream 1 = upstream Default is: 0
	Get	i:02C03			
P-GAIN	Set	s:02C04 c	s:02	FLOAT	c = 0.001...100 Default is: 0.1
	Get	i:02C04			
I-GAIN	Set	s:02C05 c	s:02	FLOAT	c = 0...100.0 Default is: 0.1
	Get	i:02C05			

Explanation: Refer to: «Fixed 1 control algorithm»

4.6.7.4 Soft pump control algorithm

Parameter	Command	Request	Data Type	Values
RAMP TIME	Set	s:02D01c	s:02	FLOAT c = 0.00...1'000'000.0 Default is: 0.00
	Get	i:02D01	i:02D01c	
RAMP MODE	Set	s:02D02c	s:02	UINT c = 0...1 0 = constant time 1 = constant slope Default is: 0
	Get	i:02D02	i:02D02c	
P-GAIN	Set	s:02D04c	s:02	FLOAT c = 0.001...100 Default is: 0.1
	Get	i:02D04	i:02D04c	

Explanation:

RAMP TIME

Pressure setpoint ramp time [s]

RAMP MODE

Mode = 0 Constant Time	The RAMP TIME is dependent on the adjusted parameter ramp time and is always the same independent of the control deviation. That means the ramp time from the actual value to the setpoint value is the adjusted parameter ramp time value.
Mode = 1 Constant Slope	The RAMP TIME is dependent on the adjusted parameter ramp time and is different depending on the control deviation. The RAMP TIME is calculated corresponding to the sensor full scale value (10V). Ramp time = 10 sec ; ramp time slope is SFS (10V) in 10 Seconds.

P-GAIN

The P-GAIN is the proportional factor of the fixed control algorithm.



To optimize soft pump control algorithm, refer to chapter «Tuning of control performance».

4.7 Tuning of control performance

- Tuning of pressure control performance with adaptive control, refer to chapter: 4.7.1 Tuning of control performance with adaptive pressure controller
- Tuning of pressure control performance with PI control, refer to chapter: 4.7.2 Tuning of control performance with fixed PI pressure controller
- Tuning of control pressure performance with Soft pump , refer to chapter: 4.7.3 Tuning of control performance with soft pump pressure controller

4.7.1 Tuning of control performance with adaptive pressure controller

Normally the default settings will result in good pressure control performance. For some applications tuning may be required to improve performance. The tuning procedures for each parameter (grey boxes) and its default values are described separately below. Strictly keep the procedure order.

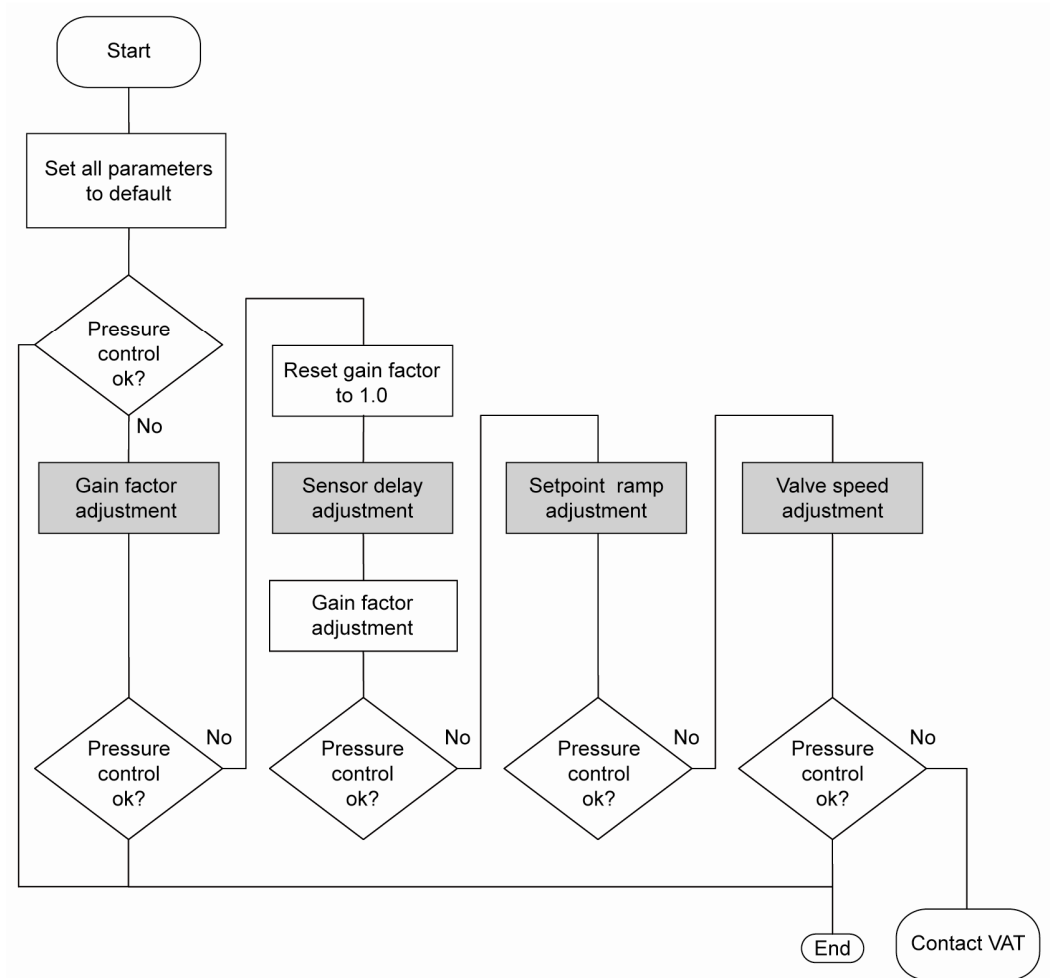

4.7.1.1 Gain factor adjustment

The gain factor effects: **Stability, Response time**

Adjustment range is from 0.0001 to 7.5.

- Higher gain results in: faster response / higher over- / undershoot of pressure
- Lower gain results in: slower response/ lower over- / undershoot of pressure

Adjustment procedure:

1. Start with gain factor 1.0
2. Open valve

3. Control a typical pressure / flow situation
4. Repeat from step 2 with lower (higher) gain factors until optimal pressure response is achieved and stability is ok.



Normally adjustments down to gain factors of 0.42 should lead to good results. Otherwise you may need to improve sensor connection. Refer to «Requirements to sensor connection».

Local operation: ('Control Performance Analyzer' or 'Service Box 2')	Remote operation: (Refer to chapter «Pressure control algorithm» > «Adaptive control algorithm» for details)
With CPA: <ul style="list-style-type: none"> • Do the 'Gain Factor' adjustment in menu 'Pressure Control' / 'Setup' / 'adaptive downstream'. With SB2: <ul style="list-style-type: none"> • Do the 'Gain Factor' adjustment in menu 'Setup / Control Parameter' 	Send 'GAIN FACTOR'

4.7.1.2 Sensor delay adjustment

Sensor delay adjustment effects: **Stability**

Adjustment range is from 0 to 1.0s.

Pipes and orifices for sensor attachment delay response time and so badly impact pressure control stability.

By adapting this parameter to the approximate delay time stability problems can be reduced. But control response time will be slowed down by this measure.



Whenever possible sensors should be attached to the chamber according to «Requirements to sensor connection». This is the most effective measure against stability issues. If your gauge attachment fulfills these criteria do not use this parameter.

Adjustment procedure:

1. Start with gain factor 1.0 and sensor delay 0s.
2. Open valve
3. Control a typical pressure / flow situation
4. Adjustment gain factor again. Refer to «Gain factor adjustment».

Local operation: ('Control Performance Analyzer' or 'Service Box 2')	Remote operation: (Refer to chapter «Pressure control algorithm» > «Adaptive control algorithm» for details)
With CPA: <ul style="list-style-type: none"> • Do the 'Sensor Delay' adjustment in menu 'Pressure Control' / 'Setup' / 'adaptive downstream'. With SB2: <ul style="list-style-type: none"> • Do the 'Sensor Delay' adjustment in menu 'Setup / Control Parameter' 	Send 'SENSOR DELAY'

4.7.1.3 Setpoint ramp adjustment

Setpoint ramp effects: **Undershoot of pressure, Response time**

Adjustment range for Setpoint Ramp is from 0 to 10 s.

This parameter defines the time that is used to decrease / raise pressure between 2 setpoints. Especially in pressure decrease situations at low flows pressure response can be improved much by adapting setpoint ramp time.

Pressure chart

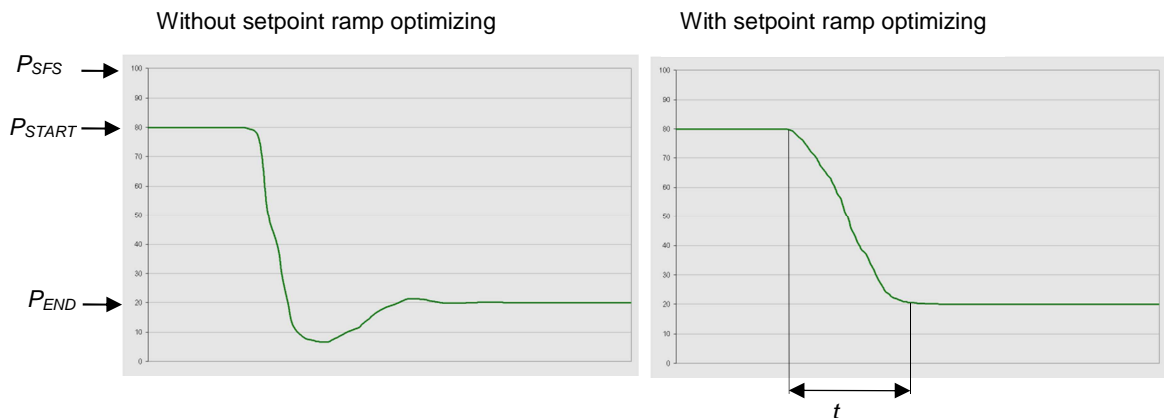

Choose the applicable formula depending on units you are familiar with.

$$t = \text{Setpoint Ramp}$$

Adjustment procedure:

5. Start with optimal gain factor and sensor delay time according to preceding tuning steps.
6. Control a typical pressure / flow situation.
7. Control a lower pressure.
8. Repeat from step 2 with longer setpoint ramps until best response is achieved.
9. Verify pressure control response for a setpoint raise situation.



In case a long ramp time is required to get optimal performance for pressure decrease situations it may be of advantage to apply different settings for decrease / raise control situations.

Local operation: ('Control Performance Analyzer' or 'Service Box 2')	Remote operation: (Refer to chapter «Pressure control algorithm» > «Adaptive control algorithm» for details)
With CPA: <ul style="list-style-type: none"> Do the 'Ramp Time' and 'Ramp Mode' adjustment in menu 'Pressure Control' / 'Setup' / 'adaptive downstream'. With SB2: <ul style="list-style-type: none"> Do the 'Setpoint Ramp' adjustment in menu 'Setup / Control Parameter' (Ramp Mode is not possible with SB2) 	Send 'RAMP TIME ' and 'RAMP MODE'

4.7.1.4 Valve speed adjustment

Valve speed effects: **Response time**

Default value is 1000. Adjustment range is from 1 to 1000.

This parameter effects valve plate actuating speed. Speed adjustment is effective for PRESSURE CONTROL and POSITION CONTROL.



Normally best pressure control response is achieved with max. valve speed. In particular applications it may be of advantage to have a slower valve response. OPEN and CLOSE are always done with maximum speed.

Adjustment procedure:

- Use optimal gain factor, sensor delay time and setpoint ramp according to preceding tuning steps.
- Open valve.
- Control a typical pressure / flow situation.
- Repeat from step 2 with slower valve speed until required response is achieved.

Local operation: ('Control Performance Analyzer' or 'Service Box 2')	Remote operation: (Refer to chapter «Setup command» > «VALVE SEED» for details)
With CPA: <ul style="list-style-type: none"> Do the 'Valve Speed' in menu 'Valve' / 'Setup' / 'valve speed'. With SB2: <ul style="list-style-type: none"> Do the 'Valve Speed' adjustment in menu 'Setup / Control Parameter' 	Send 'VALVE SEED'

Required information for support:

- Go to 'Tools / Create Diagnostic File' in 'Control View' resp. 'Control Performance Analyzer' and save file
- Pressure / flow / gas conditions to be controlled
- Chamber volume
- Pumping speed (l/s) and pump type (e.g. turbo pump)
- System description
- Problem description

Send diagnostic file with and all required information to tuning-support@vat.ch

4.7.2 Tuning of control performance with fixed PI pressure controller

4.7.2.1 Optimizing P gain and I gain

This valve may be used for downstream or upstream pressure control depending on configuration. The PI parameters of the pressure controller require correct adjustment. These parameters must be set once during system setup and are stored in the device memory which is power fail save. Based on the PI controller configuration, the valve is able to run fast and accurate pressure control cycles. The PI parameters can be evaluated using below instruction.



- In downstream control mode valve will move towards open when current pressure is higher than set point.
- In upstream control mode valve will move towards close when current pressure is higher than set point.

Local operation: ('Control Performance Analyzer')	Remote operation: (Refer to chapter «Pressure control algorithm» > «Fixed 1 or Fixed 2 control algorithm» for details)
With CPA: Do the 'Fixed 1' or 'Fixed 2' adjustment in menu 'Pressure Control' / 'Setup' / 'fixed 1' / 'fixed 2'.	Send 'Fixed 1 or 2 control algorithm parameter'.

Introduction

PI controller mode is used if for any reason (e.g. too long system time constant) the adaptive control mode does not provide satisfying control performance.

In PI controller mode the parameters P gain and I gain have to be set according to the systems characteristics. The best set of parameters can be found by using the empiric method below.

14. Optimizing P gain and I gain.

1.1 Pressure and gas flow for optimization

A PI controller delivers the best results for a certain working point (pressure/gas flow). If there is only one working point, this pressure and gas flow has to be used for optimizing P and I gain. If there are several working points that have to be covered, the pressure for optimizing is the medium pressure between highest and lowest pressure to be controlled, the gas flow for optimizing is the highest flow out of all working points.

Two different pressure set points are necessary for optimization. Set point 1 (SP1) is the pressure for optimizing as determined above. Set point 2 (SP2) is about 10 - 20% lower than SP1.

Example: pressure range: 4 – 10 Torr
 Flow range: 2 – 4 slm

Pressure set points and gas flow for optimization:
 SP1 = 7 Torr
 SP2 = 6 Torr
 Gas flow = 4slm

1.2 Optimizing P gain

While optimizing P gain, the gas flow determined above has to be constant all the time.

Start optimization with P gain set to 1.0 and I gain set to 0.0.

Set chamber pressure to SP2, wait until the pressure is stable. Set pressure to SP1. If the transition from SP2 to SP1 results in a significant pressure over shoot or even does not stabilize at all, the P gain is too high. If there is no over shoot and the pressure reaches SP1 asymptotically and very slow, P gain is too low.

The optimal P gain value is found if the transition from SP2 to SP1 results in a slight pressure over shoot. It does not matter if there is still a deviation between SP1 and actual pressure.

Example:

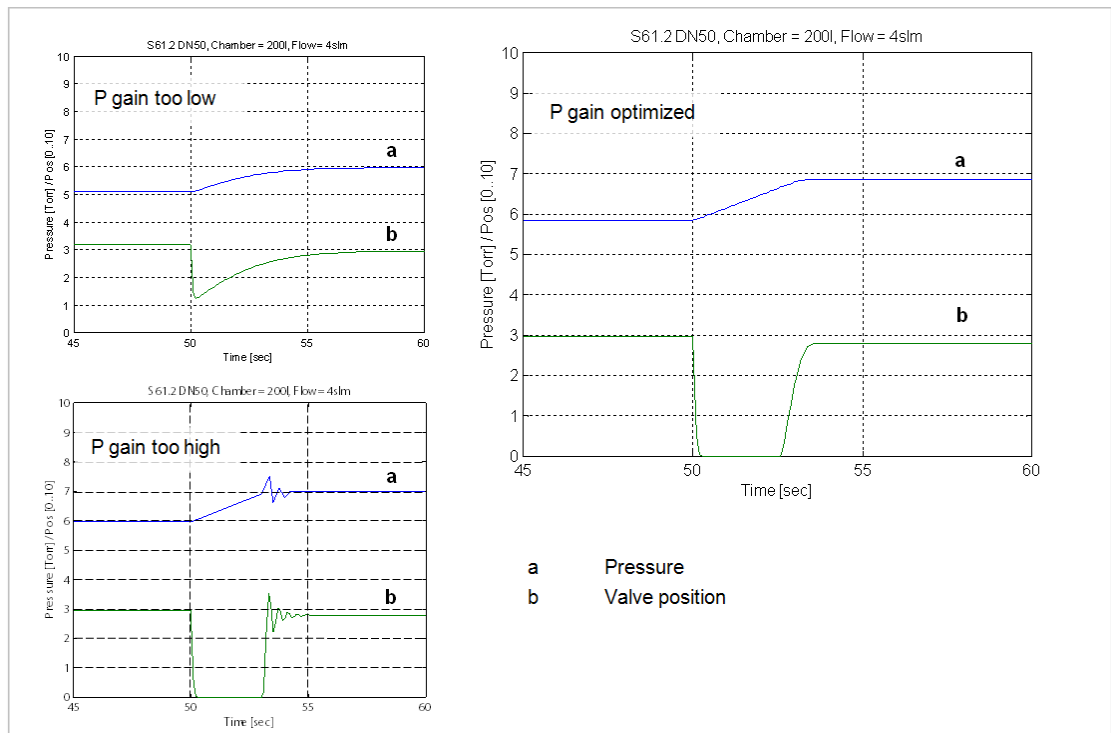

1.3 Optimizing I gain

While optimizing I gain, the gas flow determined above has to be constant all the time.

Start with P gain set to half of the value found when optimizing P gain and set I gain to 1.0. Keep the P gain constant.

Set chamber pressure to SP2, wait until the pressure is stable. Set pressure to SP1. If the transition from SP2 to SP1 results in a significant pressure over shoot or if the valve position does not stabilize, I gain is high. If the transition results in a slow asymptotical pressure rise and there is still a constant deviation to SP2, the I gain is too low.

The optimal value for I gain is found if the transition from SP2 to SP1 result in just a slight pressure over shoot, a stable valve position and the actual pressure matches SP2 exactly.

Example:

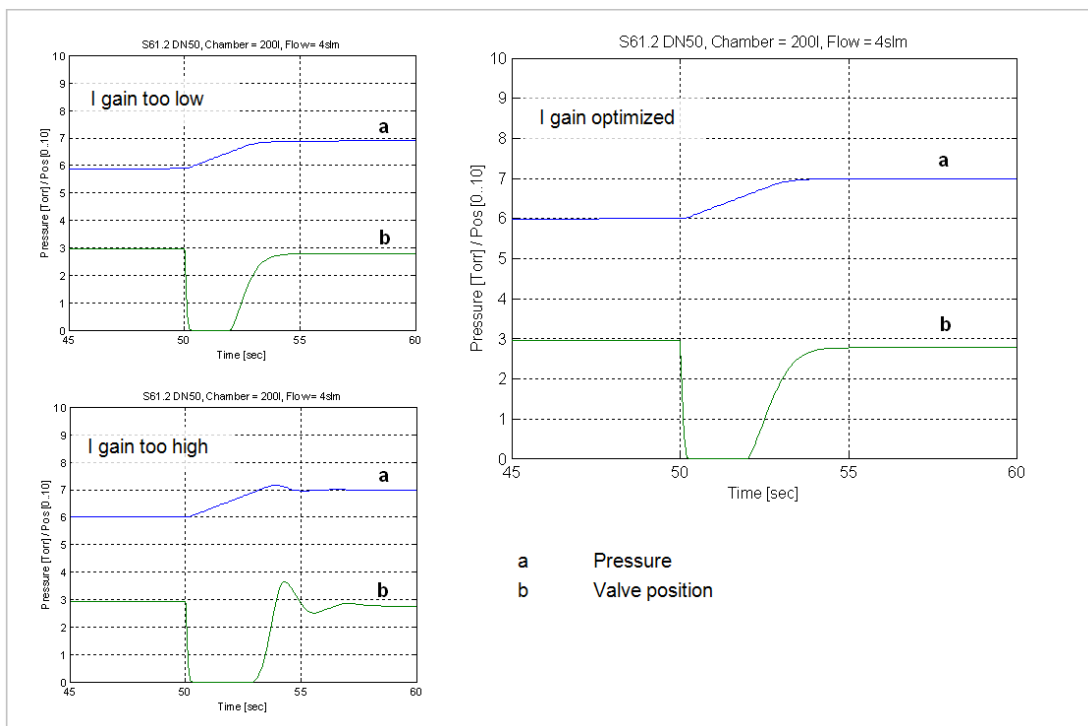

Check control performance over the whole control range with parameters above.

Required information for support:

- Go to 'Tools / Create Diagnostic File' in 'Control View' resp. 'Control Performance Analyzer' and save file
- Pressure / flow / gas conditions to be controlled
- Chamber volume
- Pumping speed (l/s) and pump type (e.g. turbo pump)
- System description
- Problem description

Send diagnostic file with and all required information to tuning-support@vat.ch

4.7.3 Tuning of control performance with soft pump pressure controller

4.7.3.1 Optimizing P gain

This valve may be used to control pressure ramps during pump down. The P parameter of the pressure controller requires correct adjustment. This parameter must be set once during system setup and is stored in the device memory which is power fail save. Based on the soft pump controller configuration, the valve is able to run fast and accurate pressure control cycles. The P parameter can be evaluated using below instruction.

Local operation: ('Control Performance Analyzer')	Remote operation: (Refer to chapter «Pressure control algorithm» > «Soft pump control algorithm» for details)
With CPA: Do the 'Soft pump' adjustment in menu 'Pressure Control' / 'Setup' / 'soft pump'.	Send 'Soft pump control algorithm parameter'.

Introduction

Pump down control mode allows a completely user-defined pressure profile, usually from atmosphere down to some process pressure

15. Optimizing P gain

The P gain value evaluated for soft pump control mode might be different than the P gain value evaluated for PI controller mode. When switching to pump down control mode the P gain value evaluated for the PI controller has to be send to the valve controller. When switching back into PI controller mode the respective P gain value has to be send again.

Adaptive pressure control mode ignores any P gain value.

1.1 Basic settings

The pump down characteristic is determined by start pressure, end pressure and pump down time. This straight line from start pressure to end pressure.

The VAT soft pump controller requires a pump down time shorter than 10 sec. for good control results. If the required pump down time is longer than 10 sec., the pump down curve has to be partitioned into sections shorter than 10 sec. with corresponding end pressure.

Example:

Start pressure: 760 Torr
End pressure: 10 Torr
Pump down time: 30 sec.

Here the pump down time and the corresponding pressure is being divided into three sections. The host sends a new pressure set point every 10 sec.:

Time	Set point
0 sec.	760 Torr
10 sec.	510 Torr
20 sec.	260 Torr
30 sec.	10 Torr

1.2 Optimizing P gain

WE start by setting the P gain to 1.0 as a trial value and adjust according to the response. The pump down routine has to be controlled as follows:

Move control valve into close position

Start pump down by opening the pump isolation valve or starting the pump and sending the first pressure set point to the valve controller. With the example above, the first pressure set point is 510 Torr.

At each new interval (exceeding 10 sec) send the new pressure set point.

Repeat until process pressure is achieved.

While pumping down chamber pressure and valve position should be data logged to compare the actual pump down curve with the ideal straight pump down line.

If the pressure follows the ideal pump down line with significant delay, the P gain is too low.

If the pressure oscillates around the ideal pump down line or if the valve position oscillates, P gain is too high.

P gain is optimized if the pressure follows the ideal pump down line closely and the valve position is not oscillating at all.

Example:

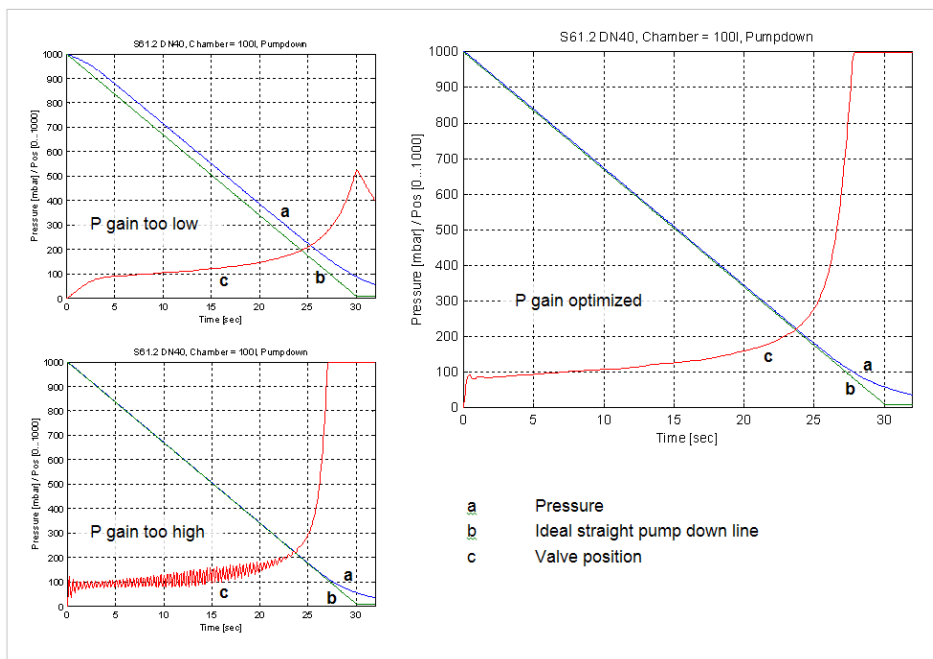

Required information for support:

- Go to 'Tools / Create Diagnostic File' in 'Control View' resp. 'Control Performance Analyzer' and save file
- Pressure / flow / gas conditions to be controlled
- Chamber volume
- Pumping speed (l/s) and pump type (e.g. turbo pump)
- System description
- Problem description

Send diagnostic file with and all required information to tuning-support@vat.ch

4.8 RS485 interface commands

4.8.1 RS485 command syntax

- Commands and values are case sensitive.
- Acknowledgement within 10ms after reception of command.
- Wait for acknowledgement before sending a new command.
- Command termination of each command is CR and LF.
CR = Carriage Return (0D hexadecimal), LF = Linefeed (0A hexadecimal)

4.8.2 Addressed communication

Applicable for addressed RS485 communication only. In case of RS485 Point-to-Point setup, addressing is not necessary.

Command

0	1	2	3	4	...	n+3	n+4
#	a	a	a	c	c	CR	LF

Description

code	description	data range
#	identification sign (ascii 35)	
aaa	device address	000 - 999
c	command	refer to standard command set

Example

Description: Send "Close" command to valve with RS485 device address 015
 Command: #015C:[CR][LF]
 Answer: #015C:[CR][LF]

4.8.3 Control commands

Control function	Command		Acknowledgement
	Description		
CLOSE VALVE	Set	C:	C:
	Valve will close.		
OPEN VALVE	Set	O:	O:
	Valve will open.		
HOLD	Set	H:	H:
	This function stops the valve at the current position. It is effective in PRESSURE CONTROL and POSITION CONTROL. The function can be revoked by a POSITION CONTROL, PRESSURE CONTROL, OPEN VALVE or CLOSE VALVE command.		
POSITION CONTROL	Set	R:aaaaaa	R:
	Get	i:38	i:38aaaaaaa
	data length for Set 6 characters, for Get 8 characters aaaaaa position SETPOINT, value depends on configuration, refer to «RS485 setup commands, COMMUNICATION RANGE» for details		
	Change to POSITION CONTROL mode and transfer of position SETPOINT value resp. reading of position SETPOINT. Remark: Reading returns position setpoint only in case pressure control is not selected.		
PRESSURE CONTROL	Set	S:aaaaaaaa	S:
	Get	i:38	i:38aaaaaaaa
	data length 8 characters aaaaaaaaa pressure SETPOINT, value depends on configuration, refer to «RS485 setup commands, COMMUNICATION RANGE» for details		
	Change to PRESSURE CONTROL mode and transfer of pressure SETPOINT resp. reading of pressure SETPOINT. Remark: Reading returns pressure setpoint only in case pressure control is selected, otherwise position setpoint is returned.		

4.8.4 Inquiry commands

Inquiry function	Command		Acknowledgement
	Description		

Inquiry function	Command		Acknowledgement
	Description		
POSITION	Get	A:	A:aaaaaa
	data length 6 characters aaaaaa position, return value depends on configuration, refer to «RS485 setup commands, COMMUNICATION RANGE» for details This function returns the current valve position. Remark: 999'999 is returned when the position is unknown, for example after power up during synchronization		
PRESSURE	Get	P:	P:saaaaaaa
	data length 8 characters s sign, 0 for positive readings, - for negative readings aaaaaaa pressure, return value depends on configuration, refer to «RS485 setup commands, COMMUNICATION RANGE» for details This function returns the actual pressure.		
SENSOR 1 OFFSET	Get	i:60	i:60aaaaaaaa
	data length 8 characters aaaaaaa sensor 1 offset (-140000 ... 0140000 = -1.4V ... +1.4V) This function returns the sensor 1 offset voltage (adjusted by ZERO).		
SENSOR 2 OFFSET	Get	i:61	i:61aaaaaaaa
	data length: 8 characters aaaaaaa sensor 2 offset (-140000 ... 0140000 = -1.4V ... +1.4V) This function returns the sensor 2 offset voltage (adjusted by ZERO).		
SENSOR 1 READING	Get	i:64	i:64saaaaaaa
	data length 8 characters s sign, 0 for positive readings, - for negative readings aaaaaaa sensor 1 reading, return value depends on configuration, refer to «RS485 setup commands, COMMUNICATION RANGE» for details This function returns direct reading from sensor 1 input.		
SENSOR 2 READING	Get	i:65	i:65saaaaaaa
	data length 8 characters s sign, 0 for positive readings, - for negative readings aaaaaaa sensor 2 reading, return value depends on configuration, refer to «RS485 setup commands, COMMUNICATION RANGE» for details This function returns direct reading from sensor 2 input.		

Inquiry function	Command		Acknowledgement
	Description		
DEVICE STATUS	Get	i:30	i:30 abcdefgh
	data length 8 characters		
	a	Access Mode	0 = local operation 1 = remote operation 2 = locked remote operation
	b	Control Mode	1 = synchronization 2 = POSITION CONTROL 3 = CLOSED 4 = OPEN 5 = PRESSURE CONTROL 6 = HOLD 7 = LEARN 8 = INTERLOCK OPEN (by digital input) 9 = INTERLOCK CLOSED (by digital input) C = power failure D = safety mode E = fatal error (read «FATAL ERROR STATUS» for details)
	c	Power Failure Option	0 = disabled 1 = enabled
	d	Warning	0 = no warnings 1 = warnings (read «WARNINGS» and «ERROR STATUS» for details)
	efg	Reserved	
	h	Simulation	0 = normal operation 1 = system simulation running
	This function returns status information about the valve.		
	Remark: In simulation mode the valve can demonstrate pressure control capability independent of other equipment such as vacuum chamber, flow controller and gauge. Normal operation is not possible when simulation is running.		

Control function	Command		Acknowledgement
	Description		
LEARN STATUS (adaptive pressure controller)	Get	i:32	i:32 abcdefgh
	data length 8 characters a Running 0 = No 1 = Yes b Data set present 0 = Ok 1 = No (Learn necessary) c Abortion 0 = Ok, Learn completed 1 = Abort by user 2 = Abort by control unit d Open pressure 0 = Ok 1 = > 50% learn pressure limit (gas flow too high) 2 = < 0 (no gas flow or zero done with gas flow) e Close pressure 0 = OK 1 = < 10% learn pressure limit (gas flow too low) f Pressure raising 0 = Ok 1 = pressure not raising during LEARN (gasflow missing) g Pressure stability 0 = OK 1 = sensor unstable during LEARN h Reserved do not use This function checks the status of LEARN and indicates if the conditions during LEARN were ok.		
LEARN PRESSURE LIMIT (adaptive pressure controller)	Get	i:34	i:34 aaaaaaaa
	data length 8 characters aaaaaaaaa pressure limit for LEARN, return value depends on configuration, refer to «RS485 setup commands, COMMUNICATION RANGE» for details This function returns the pressure limit applied for LEARN.		
FATAL ERROR STATUS	Get	i:50	i:50 abc
	data length 3 characters abc error code See in chapter «Trouble shooting» for details. This function returns an error code in case of any malfunction of the device.		

Inquiry function	Command		Acknowledgement
	Description		
WARNINGS	Get	i:51	i:51 abcdefgh
	<p>data length 8 characters</p> <p>a 0 = no service required 1 = service request, it is indicated when the control unit detects that motor steps are apparently not effective. This may happen when the valve is heavily contaminated or the gate seal is heavily sticking. These 'lost' steps are recognized and will be repeated to attempt target position in the short term. But in the medium term the valve requires cleaning or inspection.</p> <p>b 0 = LEARN data set present, 1 = LEARN data set not present</p> <p>c 0 = power failure battery ready 1 = power failure battery not ready</p> <p>d 0 = compressed air supply ok 1 = compressed air supply not ok</p> <p>efgh reserved, do not use</p> <p>This function returns warning information about the valve. If a warning is present countermeasure should be taken. Use RESET command to delete service request bit. Remark: Without LEARN the valve is not able to run pressure control</p>		
THROTTLE CYCLE COUNTER	Get	i:70	i:70 aaaaaaaaaa
	<p>data length 10 characters</p> <p>aaa...aaa number of throttle cycles</p> <p>This function returns the number of throttle cycles. A movement from max. throttle position to open back to max. throttle position counts as one cycle. Partial movements will be added up until equivalent movement is achieved.</p>		
ISOLATION CYCLE COUNTER	Get	i:71	i:71 aaaaaaaaaa
	<p>data length 10 characters</p> <p>aaa...aaa number of isolation cycles</p> <p>This function returns the number of isolation cycles. Each closing of the sealing ring counts as one cycle.</p>		
POWER UP COUNTER	Get	i:72	i:72 aaaaaaaaaa
	<p>data length 10 characters</p> <p>aaa...aaa number of power ups</p> <p>This function returns the number of control unit power ups.</p>		

Inquiry function	Command		Acknowledgement
	Description		
ASSEMBLY	Get	i:76	i:76 xxxxxxsyyyyyyabc
	data length	17 characters	
	xxxxxx	position, return value depends on configuration, refer to «RS485 setup commands, COMMUNICATION RANGE» for details	
	s	sign, 0 for positive pressure readings, - for negative pressure readings	
	yyyyyy	pressure, return value depends on configuration, refer to «RS485 setup commands, COMMUNICATION RANGE» for details	
	a	0 = local operation 1 = remote operation 2 = locked remote operation	
	b	0 = Initialization (refer to chapter: «Behavior during power up») 1 = synchronization 2 = POSITION CONTROL 3 = CLOSE 4 = OPEN 5 = PRESSURE CONTROL 6 = HOLD 7 = LEARN 8 = INTERLOCK OPEN (by digital input) 9 = INTERLOCK CLOSE (by digital input) C = power failure D = safety mode E = fatal error (read «FATAL ERROR STATUS» for details)	
	c	0 = no warning 1 = warning present (read «WARNINGS» and «ERROR STATUS» for details)	
	This function returns an assembly consisting of POSITION, PRESSURE and main status information for the valve.		
HARDWARE CONFIGURATION	Get	i:80	i:80 abcdefgh
	data length	8 characters	
	a	0 = Power Failure Option (PFO) not equipped 1 = Power Failure Option (PFO) equipped	
	b	0 = ±15V sensor power supply (SPS) not equipped 1 = ±15V sensor power supply (SPS) equipped	
	c	2 = RS232 Interface without analog outputs 3 = RS232 Interface with analog outputs	
	d	1 = 1 sensor version, 2 = 2 sensor version	
	efgh	reserved, do not use	
	This function returns the hardware configuration of the device.		
FIRMWARE CONFIGURATION	Get	i:82	i:82 aaaaaaaa
	data length	8 characters	
	aaaaaaaa	firmware version, e.g. 600P1G0002	
	This function returns firmware version of the device.		
IDENTIFICATION	Get	i:83	i:83 aaaaaaaaaaaaaaaaaaaa
	data length	20 characters	
	aaa...aaa	identification code, e.g. /0001/, unused digits are filled up with spaces (20 hexadecimal)	
	This function returns an identification code. This code is unique for each valve and allows tracing.		

Inquiry function	Command	Acknowledgement
	Description	
FIRMWARE NUMBER	Get i:84	i:84aaaaaa
	data length 20 characters aaaaaa Firmware number e.g. 700989 This function returns the VAT Firmware number.	

Setup function	Command		Acknowledgement
	Description		
SENSOR SCALE	Set	s:05aaaaabcd	s:05
	Get	i:05	i:05aaaaabcd
	data length 8 characters a Value 00001...99999 (10000 = 1.0000) b Sign Exponent 0 = “-“, 1 = “+” c Exponent 0...4 d Pressure Unit 0 = Pa 1 = bar 2 = mbar 3 = ubar 4 = Torr 5 = mTorr 6 = atm 7 = psi 8 = psf Example: 10000114 = 10Torr (input from high range sensor)		
SENSOR 1 LINEARIZATION	Set	s:17aaaabbbb	s:17
	Get	i:17	i:17aaaabbbb
	data length 8 characters a logarithmic resolution[millivolt /decade] 0000 = linearizing off 0001 = min. value 9999 = max. value (default value: 0000 = linearizing off) b full scale [millivolt] 0001 = min. value 9999 = max. value (default value in logarithmic mode: 5324 = 5.324V) (becomes linear full scale = 1000000) Pressure control algorithm adaptive downstream needs a linear sensor signal, therefore a logarithmic signal must be linearized. Example: s:1700000000 = Linear sensor Example: s:1810007800 = Logarithmic sensor (1.0V/decade, Linear full scale at 7.8V)		

Setup function	Command		Acknowledgement
	Description		
SENSOR 2 LINEARIZATION	Set	s:18 aaaabbbb	s:18
	Get	i:18	i:18 aaaabbbb
	<p>data length 8 characters</p> <p>a logarithmic resolution[millivolt /decade] 0000 = linearizing off 0001 = min. value 9999 = max. value (default value: 0000 = linearizing off)</p> <p>b full scale [millivolt] 0001 = min. value 9999 = max. value (default value in logarithmic mode: 5324 = 5.324V) (becomes linear full scale = 1000000)</p> <p>Pressure control algorithm adaptive downstream needs a linear sensor signal, therefore a logarithmic signal must be linearized.</p> <p>Example: s:1700000000 = Linear sensor Example: s:1810007800 = Logarithmic sensor (1.0V/decade, Linear full scale at 7.8V)</p>		
SENSOR AVERAGE	Set	s:19 abbbbbbb	s:19
	Get	i:19	i:19 abbbbbbb
	<p>data length 8 characters</p> <p>a Average time 0 = 0.0 sec 1 = 0.1 sec 2 = 0.2 sec 3 = 0.3 sec 4 = 0.4 sec 5 = 0.5 sec 6 = 0.6 sec 7 = 0.7 sec 8 = 0.8 sec 9 = 0.9 sec A = 1.0 sec</p> <p>b Reserved set to 0000000</p> <p>Remark: For pressure control averaging of sensor signal is not recommended. This function does the sensor average configuration.</p>		

Setup function	Command		Acknowledgement
	Description		
COMMUNICATION RANGE CONFIGURATION	Set	s:21 abcdefgh	s:21
	Get	i:21	i:21 abcdefgh
	<p>data length 8 characters a range for POSITION: 0 = 0 – 1'000, 1 = 0 – 10'000, 2 = 0 – 100'000 bcdefgh upper value for PRESSURE and SENSOR READING: 1000 ... 1000000 e.g. 0010000 -> pressure range 0 – 10'000</p> <p>This function defines the communication range between the valve and the host computer for POSITION, PRESSURE and SENSOR READING. Remark: In case ZERO has been performed, gauge offset for PRESSURE and SENSOR READING is compensated. Remark: In case 2 sensor operation for pressure control is selected, PRESSURE covers high range gauge because switchover between sensors is done automatically. SENSOR 1 READING and SENSOR 2 READING always return full scale values according to selected range.</p>		

Setup function	Command		Acknowledgement)
	Description		
INTERFACE CONFIGURATION 1	Set	s:20 abcdefgh	s:20
	Get	i:20	i:20 abcdefgh
	data length 8 characters		
	a	baud rate: 0 = 600 1 = 1200k 2 = 2400 3 = 4800 4 = 9600 5 = 19.2k 6 = 38.4k 7 = 57.6k 8 = 115.2k	
	b	parity bit: 0 = even 1 = odd 2 = mark 3 = space 4 = no	
	c	data length: 0 = 7 bit 1 = 8 bit	
	d	number of stop bits: 0 = 1 1 = 2	
	e	0 (reserved, do not change)	
	f	digital input OPEN VALVE: 0 = not inverted 1 = inverted 2 = disabled	
	g	digital input CLOSE VALVE: 0 = not inverted 1 = inverted 2 = disabled	
h	0 (reserved, do not change)		
This function does the RS485 and digital input configuration. Note: Digital outputs are always enabled.			
INTERFACE CONFIGURATION 2	Set	s:22 abbbcxxx	s:22
	Get	i:22	i:22 abbbcxxx
	data length 8 characters		
	a	1 = RS485, 2 = RS485 / Point to Point	
	bbb	RS485 address 0...255	
c	0 = full duplex, 1 = half duplex		
xxx	000 (reserved, do not change)		
This function defines the interface configuration for the valve.			

Setup function	Command		Acknowledgement
	Description		
ZERO	Set	Z:	Z:
	This command initiates ZERO to compensate for offset of gauge(s). Remark: Refer to «ZERO» for correct zero procedure.		
PRESSURE ALIGNMENT	Set	c:6002aaaaaaaa	c:60
	data length: 8 characters aaaaaaaaa System base pressure, value depends on configuration, refer to «RS485 setup commands, COMMUNICATION RANGE» for details. Alignment range is equivalent to max. +/-1.4V sensor signal. This command aligns PRESSURE to a certain value. Also SENSOR READING will be aligned accordingly. It might be used instead of ZERO in case base pressure is not low enough.		
LEARN (adaptive)	Set	L:0aaaaaaaa	L:
	data length 8 characters aaaaaaaaa Pressure limit for LEARN, value depends on configuration, refer to «RS485 setup commands, COMMUNICATION RANGE» for details This command starts LEARN. By OPEN VALVE, CLOSE VALVE or POSITION CONTROL commands the routine may be interrupted. Remark: Without LEARN the PID adaptivecontroller is not able to perform pressure control. Refer to «Adaptive algorithm» for correct learn gas flow and procedure.		
DOWNLOAD LEARN DATA	Set	d:pppddddddd	d:ppp
	data length 3 + 8 characters ppp pointer, 000 ... 103 dddddddd single data set This command downloads the LEARN data sets from the host computer to the valve. There are a total number of 104 data sets. Each data set consists of 8 data bytes and needs to be uploaded separately. Remark: Make sure that all 104 data sets will be downloaded.		
UPLOAD LEARN DATA	Get	u:ppp	u:pppddddddd
	data length 3 + 8 characters ppp pointer, 000 ... 103 dddddddd single data set This command uploads the LEARN data sets from the valve up to the host. There are a total number of 104 data sets. Each data set consists of 8 data bytes and needs to be uploaded separately. Remark: Make sure that all 104 data sets will be uploaded.		

Setup function	Command		Acknowledgement
	Description		
VALVE SPEED	Set	V:00aaaa	V:
	Get	i:68	i:680000aaaa
	data length 6 characters starting with double zero for writing 8 characters starting with quadruple zero for reading aaaa valve speed, 1 ... 1000 (1 = min. speed, 1000 = max. speed) This command allows changing the actuating speed of the valve plate. Speed selection is effective for pressure control and position control. Open valve and close valve are always done with max. speed. Remark: Refer to «Valve speed adjustment» for details.		
RESET	Set	c:82aa	c:82
	data length 2 characters aa 00 = reset service request bit from WARNINGS 01 = reset FATAL ERROR (restart control unit) This function resets warnings and errors.		
PRESSURE CONTROLLER	Set	s:02Z00a select pressure controller as active pressure controller	s:02
	Get	i:02Z00 get active pressure controller	i:02Z00a
	This command selects the pressure controller mode. a Pressure controller: 0 = Adaptive downstream 1 = Fixed 1 (downstream or upstream) 2 = Fixed 2 (downstream or upstream) 3 = Soft pump Examples: <ul style="list-style-type: none"> To set the soft pump pressure controller as active pressure controller, send s:02Z003 If the answer of the command i:02Z00 is i:02Z002, the fixed 2 pressure controller is active. 		

Setup function	Command		Acknowledgement
	Description		
PRESSURE CONTROLLER CONFIGURATION	Set	s:02abbc configure parameter: set parameter bb of pressure controller a to value c	s:02
	Get	i:02abb get value c of parameter bb of pressure controller a	i:02abbc
	<p>a Pressure controller: A = Adaptive downstream pressure controller B = Fixed 1 pressure controller (downstream or upstream) C = Fixed 2 pressure controller (downstream or upstream) D = Soft pump pressure controller</p> <p>bb Parameter number (see table below)</p> <p>c Parameter value, depends on parameter number a floating-point type or a integral type value, max length = 20 characters</p> <p>floating-point type format: x.y or x Maximum length of expression: 12 Examples: 3455.1505, 21154.0 or 318</p> <p>integer type format: x Maximum length of expression: 12 Examples: 9785, 4565, 1</p> <p>For details (commands etc.), see the next tables.</p>		

4.8.5.1 Overview pressure controller

Parameter	Parameter number (bb)	Pressure controller (a)			
		A Adaptive	B Fixed 1	C Fixed 2	D Soft pump
SENSOR DELAY	00	✓	–	–	–
RAMP TIME	01	✓	✓	✓	✓
RAMP MODE	02	✓	✓	✓	✓
CONTROL DIRECTION	03	–	✓	✓	–
P-GAIN (for A = GAIN FACTOR)	04	✓	✓	✓	✓
I-GAIN	05	–	✓	✓	–

✓ Existent for this pressure controller / – Not used for this pressure controller

Command examples:

Set GAIN FACTOR of the adaptive pressure controller to the value 1.075	s:02A041.075
GET GAIN FACTOR of adaptive pressure controller	i:02A04 → Answer is i:02A041.075 → Value = 1.075
Set RAMP TIME of soft pump pressure controller to the value 281 seconds	s:02D01281
Get RAMP TIME of soft pump pressure controller	i:02D01 → Answer is i:02D01281 → Value = 281

4.8.6 Pressure control algorithm

4.8.6.1 Adaptive control algorithm (downstream)

Parameter	Command		Request	Data Type	Values
SENSOR DELAY	Set	s:02A00 c	s:02	FLOAT	c = 0.00...1.00 Default is: 0.00 s
	Get	i:02A00	i:02A00 c		
RAMP TIME	Set	s:02A01 c	s:02	FLOAT	c = 0.00...1'000'000.0 Default is: 0.00 s
	Get	i:02A01	i:02A01 c		
RAMP MODE	Set	s:02A02 c	s:02	UINT	c = 0 or 1 0 = constant time 1 = constant slope Default is: 0
	Get	i:02A02	i:02A02 c		
GAIN FACTOR	Set	s:02A04 c	s:02	FLOAT	c = 0.0001...7.5 Default is: 1.0
	Get	i:02A04	i:02A04 c		

Explanation:

SENSOR DELAY

Sensor response time [s]

The SENSOR DELAY is a control parameter to compensate delays during the pressure detection. Pipes and orifices for sensor attachment can cause delays in response time and could impact badly the pressure control stability. By adapting this parameter to the approximate delay time stability problems can be reduced. But control response time will be slowed down by this measure.

RAMP TIME

Pressure setpoint ramp time [s]

RAMP MODE

Mode = 0 Constant Time	The RAMP TIME is dependent on the adjusted parameter ramp time and is always the same independent of the control deviation. That means the ramp time from the actual value to the setpoint value is the adjusted parameter ramp time value.
Mode = 1 Constant Slope	The RAMP TIME is dependent on the adjusted parameter ramp time and is different depending on the control deviation. The RAMP TIME is calculated corresponding to the sensor full scale value (10V). Ramp time = 10 sec.; ramp time slope is SFS (10V) in 10 Seconds.

In the adaptive pressure controller mode, the RAMP TIME parameter also can be a value to minimize over- / undershooting. The ramp could be used to harmonize the adaptive control algorithm.

GAIN FACTOR

The GAIN FACOTR is a control parameter to adapt the performance of the pressure control algorithm. A higher gain results in faster response, higher over- / undershoot of pressure. A lower gain results in slower response, lower over- / undershoot of pressure.

Example:

Set SENSOR DELAY of the adaptive pressure controller to the value 0.75

Command	Pressure controller	Parameter selection variable	Parameter value (seconds)
s:02	A (a)	00 (bb)	0.75 (c)

→ s:02A000.75



To optimize adaptive control algorithm, refer to chapter «Tuning of control performance».

4.8.6.2 Fixed 1 control algorithm

Parameter	Command		Request	Data Type	Values
RAMP TIME	Set	s:02B01 c	s:02	FLOAT	c = 0.00...1'000'000.0 Default is: 0.00
	Get	i:02B01	i:02B01 c		
RAMP MODE	Set	s:02B02 c	s:02	UINT	c = 0 or 1 0 = constant time 1 = constant slope Default is: 0
	Get	i:02B02	i:02B02 c		
CONTROL DIRECTION	Set	s:02B03 c	s:02	UINT	c = 0 or 1 0 = downstream 1 = upstream Default is: 0
	Get	i:02B03	i:02B03 c		
P-GAIN	Set	s:02B04 c	s:02	FLOAT	c = 0.001...100 Default is: 0.1
	Get	i:02B04	i:02B04 c		
I-GAIN	Set	s:02B05 c	s:02	FLOAT	c = 0...100.0 Default is: 0.1
	Get	i:02B05	i:02B05 c		

Explanation:

RAMP TIME

Pressure setpoint ramp time [s]

RAMP MODE

Mode = 0 Constant Time	The RAMP TIME is dependent on the adjusted parameter ramp time and is always the same independent of the control deviation. That means the ramp time from the actual value to the setpoint value is the adjusted parameter ramp time value.
Mode = 1 Constant Slope	The RAMP TIME is dependent on the adjusted parameter ramp time and is different depending on the control deviation. The RAMP TIME is calculated corresponding to the sensor full scale value (10V). Ramp time = 10 sec.; ramp time slope is SFS (10V) in 10 Seconds.

CONTROL DIRECTION

The CONTROL DIRECTION defines the type of application, if the valve is mounted in downstream or upstream. Downstream means the valve is after the chamber and before the pump. Upstream, valve is mounted before chamber and pump.

P-GAIN / I-GAIN

The P-GAIN is the proportional factor of the fixed control algorithm. The I-GAIN is the integral factor.

Example:

Set RAMP MODE of the Fixed 1 pressure controller to the value 0 (fixed time)

Command	Pressure controller	Parameter selection variable	Parameter value
s:02	B (a)	02 (bb)	0 (c)

→ s:02B020



To optimize Fixed 1 control algorithm, refer to chapter «Tuning of control performance».

4.8.6.3

Fixed 2 control algorithm

Parameter	Command	Request	Data Type	Values
RAMP TIME Pressure setpoint ramp time [s]	Set	s:02C01c	s:02	FLOAT c = 0.00...1'000'000.0 Default is: 0.00
	Get	i:02C01	i:02C01c	
RAMP MODE	Set	s:02C02c	s:02	UINT c = 0 or 1 0 = constant time 1 = constant slope Default is: 0
	Get	i:02C02	i:02C02c	
CONTROL DIRECTION	Set	s:02C03c	s:02	UINT c = 0 or 1 0 = downstream 1 = upstream Default is: 0
	Get	i:02C03	i:02C03c	
P-GAIN	Set	s:02C04c	s:02	FLOAT c = 0.001...100 Default is: 0.1
	Get	i:02C04	i:02C04c	
I-GAIN	Set	s:02C05c	s:02	FLOAT c = 0...100.0 Default is: 0.1
	Get	i:02C05	i:02C05c	

Explanation: Refer to: «Fixed 1 control algorithm»

4.8.6.4 Soft pump control algorithm

Parameter	Command		Request	Data Type	Values
RAMP TIME	Set	s:02D01 c	s:02	FLOAT	c = 0.00...1'000'000.0 Default is: 0.00
	Get	i:02D01	i:02D01 c		
RAMP MODE	Set	s:02D02 c	s:02	UINT	c = 0...1 0 = constant time 1 = constant slope Default is: 0
	Get	i:02D02	i:02D02 c		
P-GAIN	Set	s:02D04 c	s:02	FLOAT	c = 0.001...100 Default is: 0.1
	Get	i:02D04	i:02D04 c		

Explanation:

RAMP TIME

Pressure setpoint ramp time [s]

RAMP MODE

Mode = 0 Constant Time	The RAMP TIME is dependent on the adjusted parameter ramp time and is always the same independent of the control deviation. That means the ramp time from the actual value to the setpoint value is the adjusted parameter ramp time value.
Mode = 1 Constant Slope	The RAMP TIME is dependent on the adjusted parameter ramp time and is different depending on the control deviation. The RAMP TIME is calculated corresponding to the sensor full scale value (10V). Ramp time = 10 sec ; ramp time slope is SFS (10V) in 10 Seconds.

P-GAIN

The P-GAIN is the proportional factor of the fixed control algorithm.





To optimize soft pump control algorithm, refer to chapter «Tuning of control performance».

4.8.7 Error messages

Description	Error message
Protocol	
Parity error	E:000001
Input buffer overflow (to many characters)	E:000002
Framing error (data length, number of stop bits)	E:000003
Overrun (Service interface: Input buffer register overflow)	E:000004
Commands	
<CR> or <LF> missing	E:000010
: missing	E:000011
Invalid number of characters (between : and)	E:000012
Invalid value	E:000023
Value out of range	E:000030
Hardware	
Pressure mode, Zero or Learn without Sensor	E:000040
Command not applicable for hardware configuration	E:000041
Setup	
ZERO disabled	E:000060
Device Status	
Command not accepted due to local operation	E:000080
Command not accepted, Service Interface locked	E:000081
Command not accepted due to synchronization, CLOSED or OPEN by digital input, safety mode or fatal error	E:000082
Not accepted calibration and test mode	E:000089

5 Operation

	⚠ WARNING
	Unqualified personnel Inappropriate handling may cause serious injury or property damage. Only qualified personnel are allowed to carry out the described work.

	⚠ WARNING
	Valve opening Risk of serious injury. Human body parts must be kept out of the valve opening and away from moving parts. Do not connect the controller to power before the valve is installed complete into the system.

5.1 Normal operation

This valve is designed for downstream pressure control in vacuum chambers. It can be employed in a pressure control mode or a position control mode. In both cases local or remote operation is possible.

5.1.1 Local operation

Local operation means that the valve is operated via the service port using a computer or the Service Box 2. When using a computer, a service cable and a software from VAT is required.

You can use our Software (freeware) 'Control Performance Analyzer' which can be downloaded from: <http://www.vatvalve.com/customer-service/informations-and-downloads/control-performance-analyzer>.

These softwares are beneficial especially for setup, testing and maintenance.

How to start:

Connect service cable between PC and valve controller, start software and push button 'LOCAL' to enable for operation. Then enter menu Sensor / Setup and do sensor configuration according to your application to make sure that you get the correct pressure displayed.

'Control Performance Analyzer' supports:

- Valve setup
- Sensor setup
- Pressure control
- Interface setup
- Manual control
- Sequence control
- Numeric and graphical monitoring
- Data recording
- Data analysis
- Advanced diagnostic

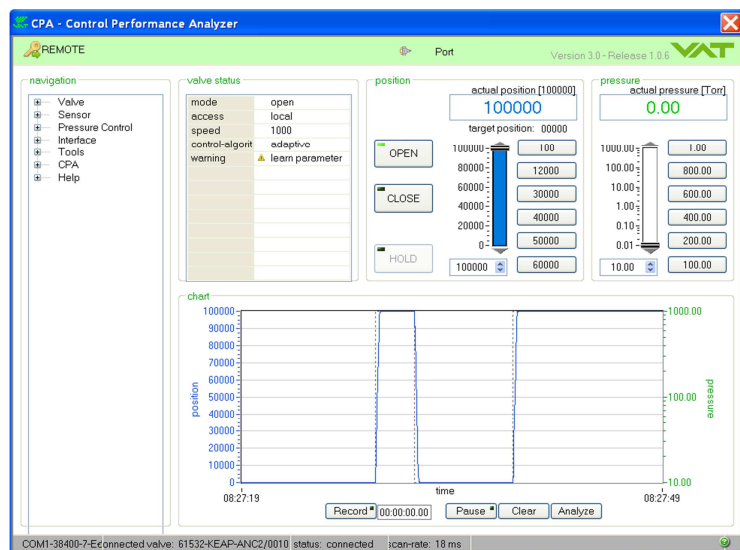

When communication to service port is interrupted the valve will change to remote operation. So when service cable will be disconnected or software will be shut down, the valve returns automatically to remote operation. This may result in an immediate movement of the valve depending on remote control.

Refer to «Accessories» for ordering numbers of service cable and Service Box 2.

5.1.2 Remote operation

This product is equipped with a RS485 interface to allow for remote operation. See section «RS485 interface» for details. 'Control Performance Analyzer' software or 'Service Box 2' may be used for monitoring during remote control.

'Control Performance Analyzer' software

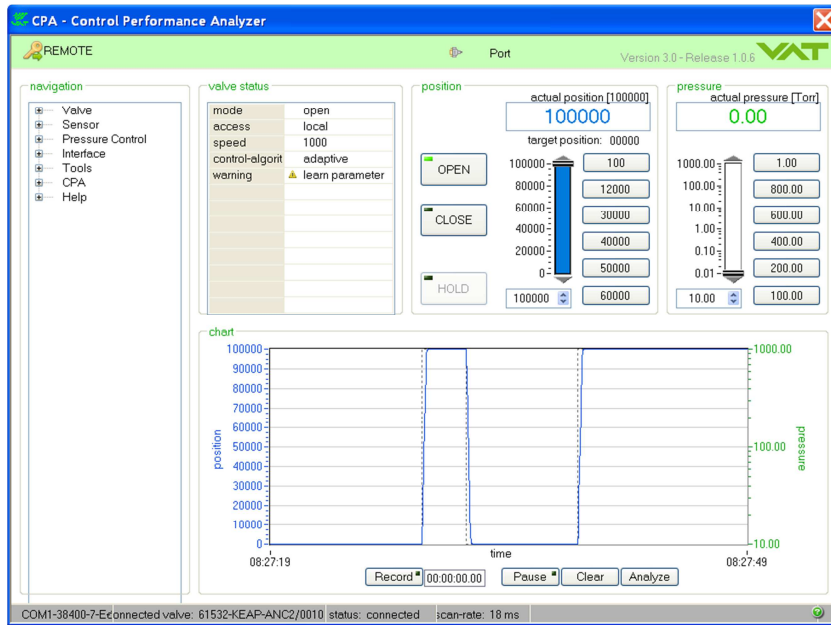

'Service Box 2'



In case 'Control Performance Analyzer' software is connected to valve make sure 'REMOTE' button is pushed to enable for remote operation. In case Service Box 2 is connected to valve make sure the LED on button 'LOCAL' is OFF for remote operation.

5.2 Close valve

Local operation: (‘Control View’, ‘Control Performance Analyzer’ or ‘Service Box 2’)	Remote operation: (Refer to chapter «Control commands» for details)
Push CLOSE button	Send CLOSE VALVE

5.3 Open valve

Local operation: (‘Control View’, ‘Control Performance Analyzer’ or ‘Service Box 2’)	Remote operation: (Refer to chapter «Control commands» for details)
Push OPEN button	Send OPEN VALVE

5.4 Position control

The valve position is directly controlled according to the position setpoint.

Local operation: (‘Control View’, ‘Control Performance Analyzer’ or ‘Service Box 2’)	Remote operation: (Refer to chapter «Control commands» for details)
Select or enter position setpoint	Send POSITION CONTROL

5.5 Pressure control



To prepare valve for PRESSURE CONTROL perform complete «Setup procedure». The valve has parameters that may be modified to tune pressure control performance. Refer to «Tuning of control performance».

The included PID controller controls the chamber pressure according to the pressure setpoint by means of the valve position. The PID controller works with an adaptive algorithm to achieve best results under altering conditions (gasflow, gas type).

Local operation: (‘Control View’, ‘Control Performance Analyzer’ or ‘Service Box 2’)	Remote operation: (Refer to chapter «Control commands» for details)
Select or enter pressure setpoint	Send PRESSURE CONTROL

5.5.1 Pressure control operation with 2 sensors

[applicable with 642 **H** - and 642 **W** - versions only]

If 2 sensor operation is enabled, changeover between the sensors is done automatically during pressure control. For configuration refer to chapter «Setup procedure». We recommend a ratio of 10:1 between the pressure gauges. Max. ratio is 100:1. High range respectively low range pressure gauge may be either connected to sensor 1 or sensor 2 input. It's required to do correct sensor configuration. Between 90 and 100% of the low range sensor full scale, the low range sensor is phased out while high range sensor is phased in during pressure rise. During pressure decrease the high range sensor is phased out while low range sensor is phased in. This maintains a functional response behavior in case of small calibration errors between the two sensors. The PRESSURE output in this range is a blend between both sensors. For monitoring purpose each sensor signal may be read out individually. Refer to «inquiry commands SENSOR 1 READING and SENSOR 2 READING»



Make sure that both sensors are calibrated. Do not close optional gauge isolation valves during the transition phase between the sensors.

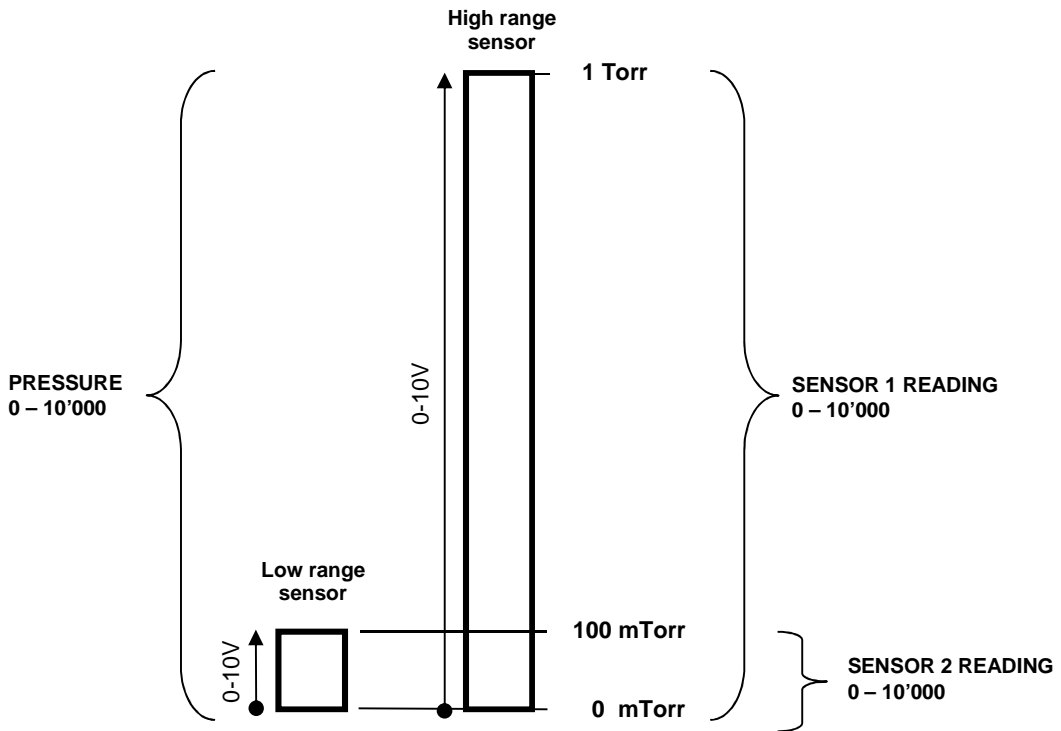

5.6 Display information

There is a 4 digit display located on the panel. It displays configuration, status and position information. For details see following tables.

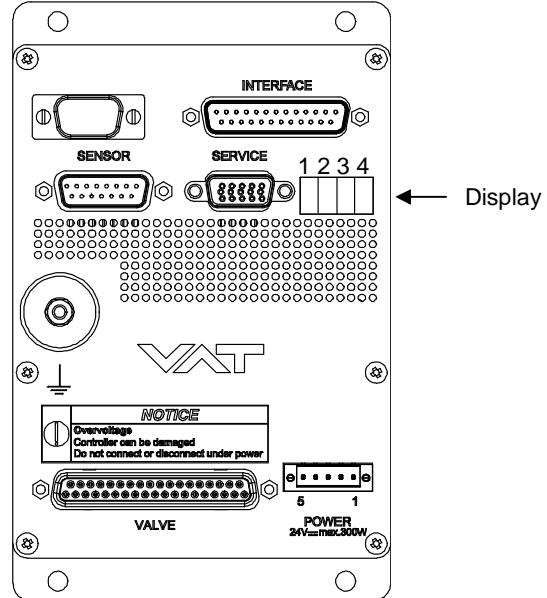

5.6.1 Power up

Description	Digit 1	Digit 2	Digit 3	Digit 4
<ul style="list-style-type: none"> Power On: All dots are illuminated 	#	#	#	#
<ul style="list-style-type: none"> 1st information for about 3s: Firmware generation [e.g. 1G..] 	1	G		
<ul style="list-style-type: none"> 2st information for about 3s: Firmware version and firmware revision [e.g. 00 06] 	0	0	0	6
<ul style="list-style-type: none"> 3rd information for about 3s: Valve type [e.g. 642] 		6	4	2
<ul style="list-style-type: none"> 4th information for about 3s: Controller configuration In case D999 is displayed, motor interlock is active. Refer to «Safety mode» for details. 		8 = RS485 interface 9 = RS485 interface with analog outputs	0 = basic 1 = with SPS ¹⁾ 2 = with PFO ²⁾ 3 = with SPS ¹⁾ and PFO ²⁾	1 = 1 sensor version 2 = 2 sensor version
SYNC indicates that powerup synchronization is running.	S	Y	N	C

¹⁾ SPS = optional ±15 VDC Sensor Power Supply module, ²⁾ PFO = Power Failure Option

5.6.2 Operation

Description / Mode	Digit 1	Digit 2	Digit 3	Digit 4
PRESSURE CONTROL mode	P	0...100 = valve position (% , 0 = closed / 100 = open)		
POSITION CONTROL mode	V			
Valve closed	C			
Valve open	O			
Closed / open interlock (Valve closed / open by digital input)	I			
HOLD (position frozen) activated	H			
ZERO running	Z			
LEARN running	L			
Safety mode established. Refer to «Safety mode» for details.	D			
Power failure	F			
Service request ¹⁾ (valve requires cleaning)			S	R

¹⁾ If SR is blinking alternatively with the actual mode display (e.g. P.11 ⇔ ..SR) the valve requires cleaning.



RxD / TxD activity of RS232 communication is displayed by 2 blinking dots in digit 2. The lower dot indicates RxD activity where the upper dot indicates TxD activity. The indication is not real time.

5.6.3 Fatal error

Description	Digit 1	Digit 2	Digit 3	Digit 4
Fatal error occurred	E	Error code. Refer to «Trouble shooting» for details		

5.6.4 Safety mode

By means of an external switch (see connection diagrams «Electrical connection») the motor power supply can be interrupted. In this case the valve enters the 'safety mode'. This motor interlock prevents the valve from moving (e.g. maintenance work). Data reading from the control unit remains possible. When motor interlock is active during power up the valve directly enters the 'safety mode' and is not able to synchronize. Display shows 'D C' or 'D999'. In this case synchronization cycle will be done when motor interlock is deactivated. Then Display shows 'INIT' for a moment followed by 'SYNC'. When 'safety mode' is entered from operation (i.e. pressure control mode), the unit will automatically switch to position control mode and remain at current position. Once motor interlock is deactivated the unit remains in position control mode.

5.6.5 Service indication

This product is able to indicate that the valve unit needs to be cleaned, or an obstruction is present. A service request is indicated when the control unit detects that motor steps are apparently not effective. This may happen when the valve unit is heavily contaminated. These 'lost' steps are recognized and will be repeated to attempt target position in the short term. But in the medium term the valve unit requires cleaning or inspection. 'Service request' (SR) would be indicated on the display or could be read via remote operation. Refer to «Display information» for details.

5.7 Operation during power up

Valve position before power up:	Reaction of valve:	
	Valve power up configuration = closed (default)	Valve power up configuration = open
Closed (isolated)	Valve remains closed. Display shows alternately 'C C' and 'INIT'. Synchronization will be done when first movement command is received.	Valve runs to max. throttle position to detect the limit stops to synchronize. Display shows configuration of product resp. 'SYNC' until synchronization is done. Valve position after power up is open.
All other than closed (not isolated)	Valve runs to max. throttle position to detect limit stop for synchronization. Display shows configuration of product resp. 'SYNC' until synchronization is done.	
	Valve position after power up is closed	Valve position after power up is open

Refer also to chapter: «Display information».

5.8 Behavior in case of power failure



Valve position before power failure:	Reaction of valve:	
	Without Power Failure Option (PFO)	With Power Failure Option (PFO)
	642 G . -	642 H . -
	642 A . -	642 C . -
	642 T . -	642 U . -
	642 V . -	642 W . -
Any	Valve remains at current position.	Valve will close or open depending on valve configuration 1). Default is not defined. Display indicates F .

1) Provide that battery pack of the VAT controller is charged. Charging time after power up is 2 minutes max..



All parameters are stored in a power fail save memory.

5.9 Operation under increased temperature

 CAUTION	
	<p>Hot valve</p> <p>Heated valve may result in minor or moderate injury.</p> <p>Do not touch valve and heating device during operation. Once heating is switched off (valve and system) await until the valve is cooled down complete before doing any work.</p>



This valve may be operated in the temperature range mentioned in chapter «Technical data».

6 Trouble shooting

Failure	Check	Action
No dots lighted on display	24 V power supply ok?	Connect valve to power supply according to «Electrical connection» and make sure that power supply is working.
Remote operation does not work	<ul style="list-style-type: none"> - Local operation via service port active - Safety mode active, check for D on display? 	<ul style="list-style-type: none"> - Switch to remote operation. - Provide power to motor to allow for operation. - Refer to «Electrical connection» for details.
Display shows «E 20» and position is 009999 (fatal error - limit stop of valve unit not detected)	Clamp coupling screw not fastened?	Tighten clamp coupling screw. Refer to chapter «Maintenance» for details. RESET or restart of valve is necessary.
Display shows «E 21» and position is 009999 (fatal error - rotation angle of valve plate limited during power up)	<ul style="list-style-type: none"> - Valve plate correctly adjusted? - Valve unit heavy contaminated? - Valve plate mechanically obstructed? 	<ul style="list-style-type: none"> - Adjust valve plate according to «Maintenance procedure». - Clean valve unit according to «Maintenance procedure». - Resolve obstruction. - Reset control unit. Cycle power (OFFàON) or - Send reset command: local via service port with CV/CPA/Service Box2
Display shows «E 22» and position is 009999 (fatal error - rotation angle of valve plate limited during operation)	<ul style="list-style-type: none"> - Valve unit heavy contaminated? - Valve plate mechanically obstructed? 	<ul style="list-style-type: none"> - Clean valve unit according to «Maintenance procedure». - Resolve obstruction. - Reset control unit. Cycle power (OFFàON) or - Send reset command: local via service port with CV/CPA/Service Box2
Display shows «E 40» and position is 009999 (fatal error - motor driver failure detected)		Replace control and actuating unit according to «Maintenance procedure».
Display shows «D 0» Motor Interlock is open	Motor power supplied?	<ul style="list-style-type: none"> - Provide power to motor to allow for operation. - Refer to «Electrical connection» for details.
Display shows «SR» (Service Request)	Valve unit heavy contaminated? Or gate seal is sticking.	<ul style="list-style-type: none"> - Clean valve unit according to «Maintenance procedures». - Reset control unit. Cycle power (OFFàON) or - Send reset command: local via service port with CV/CPA/Service Box2

Failure	Check	Action
CLOSE VALVE does not work	<ul style="list-style-type: none"> - Safety mode active, check for D on display? - Maintenance mode active 	<ul style="list-style-type: none"> - Provide power to motor to allow for operation. - Refer to «Electrical connection» for details. - Refer to "Display shows «M C»" in this table
OPEN VALVE does not work	<ul style="list-style-type: none"> - Safety mode active, check for D on display? - Maintenance mode active 	<ul style="list-style-type: none"> - Provide power to motor to allow for operation. Refer to «Electrical connection» for details. - Refer to "Display shows «M100»" in this table
Display shows «M C» Maintenance mode active		<p>Pin 14 of service connector is connected to ground. Plate will close. Further movement of plate is blocked.</p> <p>Note: Priority of pin 14 is higher than pin 13. If pin 14 is connected to ground after pin 13 the valve will close.</p> <p>Ground of service connector is at pin 4 and 8.</p>
Display shows «M100» Maintenance mode active		<p>Pin 13 of service connector is connected to ground. Plate will open. Further movement of plate is blocked.</p>
Pressure reading is wrong or pressure reading is negative	<ul style="list-style-type: none"> - Sensor(s) connected? - 2 sensor version present at valve controller? - ZERO done? - Does sensor power supply provide enough power for sensor(s)? 	<ul style="list-style-type: none"> - Refer to «Electrical connection». - Check valve version on page 1. Verify configuration. Refer to «Setup procedure». - Perform ZERO when base pressure is reached. Refer to «ZERO» for details. - Verify sensor supply voltage.
ZERO does not work	<ul style="list-style-type: none"> - Valve in open position, check for O on display? - ZERO disabled? 	<ul style="list-style-type: none"> - OPEN VALVE and bring chamber to base pressure before performing ZERO. - Enable ZERO. Refer to «Valve configuration» for details.
Pressure is not '0' after ZERO	<ul style="list-style-type: none"> - Sensor voltage shifting? - System pumped to base pressure? - Sensor offset voltage exceeds $\pm 1.4V$ 	<ul style="list-style-type: none"> - Wait until sensor does not shift any more before performing ZERO. - OPEN VALVE and bring chamber to base pressure before performing ZERO. - Replace pressure gauge.
PRESSURE CONTROL does not work	<ul style="list-style-type: none"> - Safety mode active, check for D on display? - PRESSURE CONTROL selected, check for P on display? - LEARN done? 	<ul style="list-style-type: none"> - Provide power to motor to allow for operation. Refer to «Electrical connection» for details. - Select PRESSURE CONTROL mode. Refer to «Pressure control» for details. - Perform LEARN. Refer to «Setup procedure» for details.

Failure	Check	Action
PRESSURE CONTROL not optimal	<ul style="list-style-type: none"> - Setup done completely? - LEARN done? - ZERO performed before LEARN? - LEARN interrupted? - Was gas flow stable during LEARN? - Tuning done? - Is sensor range suited for application? - Noise on sensor signal? 	<ul style="list-style-type: none"> - Perform «Setup procedure» completely. - Perform LEARN. Refer to «LEARN» for details. - Perform ZERO then repeat LEARN. Refer to «Setup procedure» for details. - Repeat LEARN. Refer to «LEARN» for details. - Repeat LEARN with stable gas flow. Refer to «LEARN» for details. - Tune valve for application. Refer to «Tuning of control performance» for details. - Use a sensor with suitable range (controlled pressure should be >3% and < 98% of sensor full scale). - Make sure a shielded sensor cable is used.



If you need any further information, please contact one of our service centers. You will find the addresses on our website: www.vatvalve.com.

7 Maintenance

	<p style="text-align: center;">⚠ WARNING</p> <p>Unqualified personnel Inappropriate handling may cause serious injury or property damage. Only qualified personnel are allowed to carry out the described work.</p>
	<p style="text-align: center;">⚠ WARNING</p> <p>Valve opening Risk of serious injury. Human body parts must be kept out of the valve opening and away from moving parts. Disconnect power on controller before doing any work.</p>
	<p style="text-align: center;">⚠ CAUTION</p> <p>Hot valve Heated valve may result in minor or moderate injury. Do not touch valve and heating device during operation. Once heating is switched off (valve and system) await until the valve is cooled down complete before doing any work.</p>
	<p style="text-align: center;">NOTICE</p> <p>Contamination Gate and other parts of the valve must be protected from contamination. Always wear clean room gloves when handling the valve.</p>

7.1 Maintenance intervals

Under clean operating conditions, the valve does not require any maintenance during the specified cycle life. Contamination from the process may influence the function and requires more frequent maintenance.

Before carrying out any maintenance, please contact VAT. It has to be individually decided whether the maintenance can be performed by the customer or has to be carried out by VAT. Please write down the fabrication number of the valve before contact VAT. Refer to chapter «Identification of product» for fabrication number.

7.2 Maintenance procedures

One maintenance procedures are defined for this valve:

- **Replacement of gate seal** (gate and bonnet seal) **and valve cleaning**



Required frequency of cleaning and replacement of seals is depending on process conditions.

VAT can give the following recommendations for preventive maintenance:

Replacement of	Recommendation
Gate seal (gate and bonnet seal)	Every 100'000 cycles



For spare parts of gate and bonnet seal refer to chapter: «Spare parts»









All pictures in maintenance procedure are sample pictures (DN63...400)

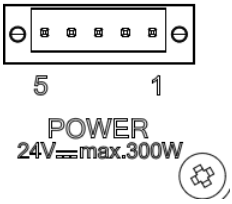
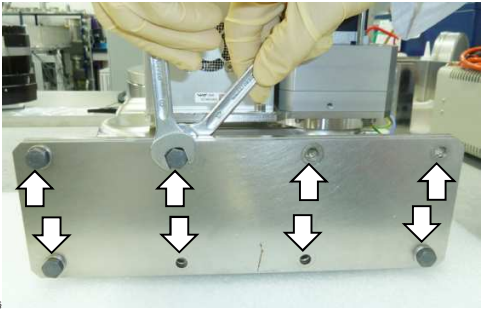

7.2.1 Replacement of gate seals and valve cleaning

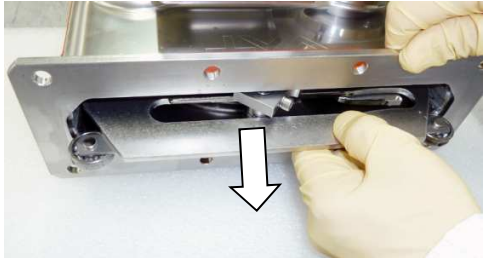

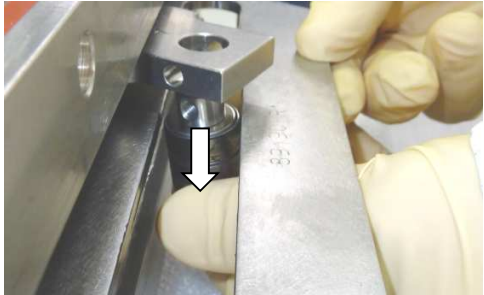
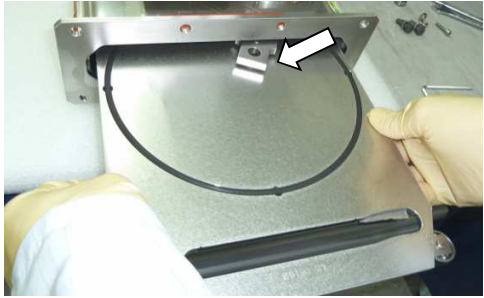

7.2.1.1 Required tools

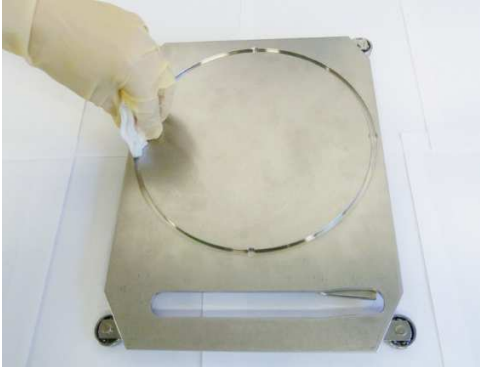
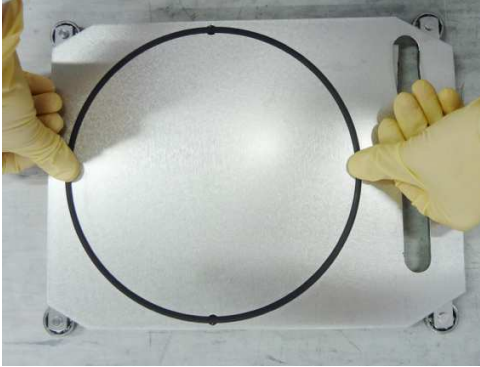
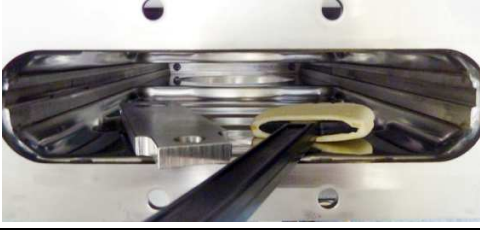
- Allen Wrench 4 mm (Allen torque wrench 4 mm)
- 2 x Open end wrench 13 mm
- Open end torque wrench 13 mm
- 2 x Open end wrench 10 mm
- Open end torque wrench 10 mm
- Isopropyl alcohol
- Vacuum grease (see chapter spare parts)
- O-ring removal tool (see chapter Accessories)
- Clean room wiper

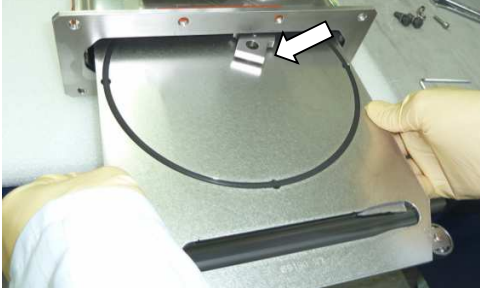
Description	Required tool	
1. Vent both valve chambers 2. Open the valve 3. Turn off power to valve controller 4. Disable power-fail option (wait 60 seconds)	CPA or Service Box 2	
5. Disconnect power cable at controller		
6. Unfasten and remove the bonnet screws		2 x Open end wrench 10 mm (DN 63 / 100) 2 x Open end wrench 13 mm (DN160...400)
7. Remove valve bonnet and bonnet seal 8. Deposit both parts on a clean place		

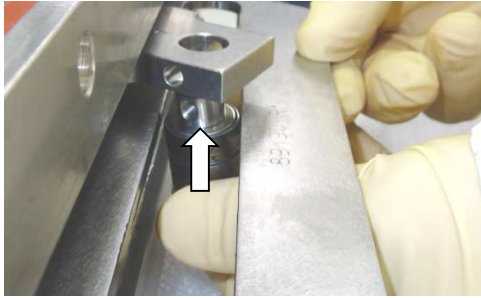
Description	Required tool	
<p>9. Pull out the gate until the crank bolt can be reached</p>		
<p>10. Loosen and remove the crank bolt screw</p>		<p>Allen wrench 4 mm</p>
<p>11. Remove the crank bolt from lever</p>		
<p>12. Pull out the gate assembly complete</p> <p>Caution! Take care that gate is not scratching at lever while pulling out</p>		
<p>13. Place the gate on a clean place</p> <p>14. Remove the gate o-ring</p>		<p>O-ring removal tool</p>

Description	Required tool	
<p>15. Clean the o-ring groove and the gate assembly</p>		<p>Clean room wiper a little soaked with isopropyl alcohol</p>
<p>16. Install the new o-ring equally in o-ring groove (for new o-ring refer to chapter: «Spare parts»)</p>		
<p>17. Clean the valve body inside</p>		<p>Cleaning tool a little soaked with isopropyl alcohol (refer to chapter «Spare parts» for cleaning tool)</p>
<p>18. Clean the sealing surface of valve</p>		<p>Clean room wiper a little soaked with isopropyl alcohol</p>
<p>19. Push in the gate assembly until...see step 20</p> <p>Caution! Take care that gate is not scratching at lever and body while pushing in.</p>		

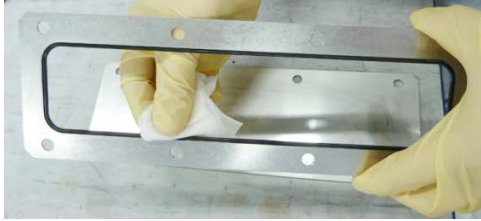
Description		Required tool
<p>20. Insert the crank bolt at lever</p>  <p>If necessary use a new crank bolt (for new crank bolt refer to chapter: «Spare parts»).</p>		
<p>21. Fasten the crank bolt screw adequately</p>		<p>Allen torque wrench 4 mm</p>
<p>22. Push in the gate assembly into valve body</p>		
<p>23. Clean the valve bonnet</p>		<p>Clean room wiper a little soaked with isopropyl alcohol</p>
<p>24. Clean or replace the bonnet seal</p> <p>25. Lubricate the seal side with 0.1 ml vacuum grease</p>  <p>If necessary to use a new bonnet seal (for new bonnet seal refer to chapter: «Spare parts»). If new bonnet seal is used (also in case of VATSEAL), no cleaning and lubrication is needed.</p>		<p>Clean room wiper Vacuum grease</p>

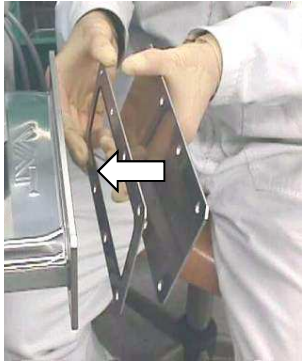
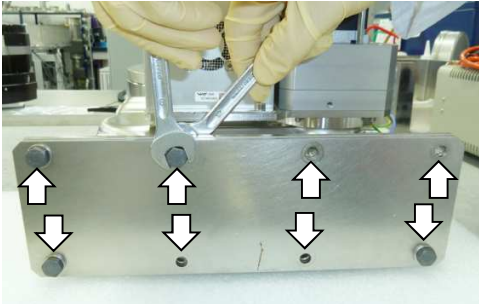
Description		Required tool		
26. Reassemble the bonnet and bonnet seal with valve				
27. Fasten the bonnet screws with: <ul style="list-style-type: none"> • DN 63 / 100 with 10 Nm • DN 160...400 with 18 Nm 		<table border="0"> <tr> <td style="padding: 5px;"> DN 63 / 100 1 x Open end torque wrench 13 mm 1 x Open end wrench 13 mm </td> </tr> <tr> <td style="padding: 5px;"> DN 160...400 1 x Open end torque wrench 13 mm 1 x Open end wrench 13 mm </td> </tr> </table>	DN 63 / 100 1 x Open end torque wrench 13 mm 1 x Open end wrench 13 mm	DN 160...400 1 x Open end torque wrench 13 mm 1 x Open end wrench 13 mm
DN 63 / 100 1 x Open end torque wrench 13 mm 1 x Open end wrench 13 mm				
DN 160...400 1 x Open end torque wrench 13 mm 1 x Open end wrench 13 mm				

7.2.2 Replacement of Option board

	NOTICE
	<p>Electrostatic discharge</p> <p>Electronic components could be damaged.</p> <p>All work on the control and actuating unit has to be done under ESD protected environment to prevent electronic components from damage.</p>

	NOTICE
	<p>Burned connector pins (spark)</p> <p>Connector pins or electronic parts could be damaged, if plugged and unplugged under power.</p> <p>Do not plug or unplug connectors under power.</p>

The option board may or may not be equipped in your valve depending on the order. Refer to page 1 of this manual to check valve version. This board includes the optional modules for the valve which are:

- ± 15 VDC sensor power supply (SPS)
- Power failure option (PFO)

It is available in 3 versions. These are:

- SPS module only
- PFO module only
- SPS and PFO module

The modules may be retrofitted or replaced easily. The battery lifetime of the PFO module depends on the ambient temperature (see below). To assure PFO function the option board must be replaced after battery life has expired. For ordering number of the modules refer to chapter «Spare parts».

7.2.2.1 Durability of power fail battery

The curves in the graph show the estimated life of Ultra Cap PFO in the worst condition (max. sensor load = 1 A, valve heating temperature = 150 °C).

If the SPS is not fully loaded (< 1 A) or heating temperature of valve body is lower than 150 °C, the corresponding life time curve will be somewhere in between the upper and the lower curve.

Therefore please determine the equivalent maintenance period for replacing the Ultra Cap battery (Option board).

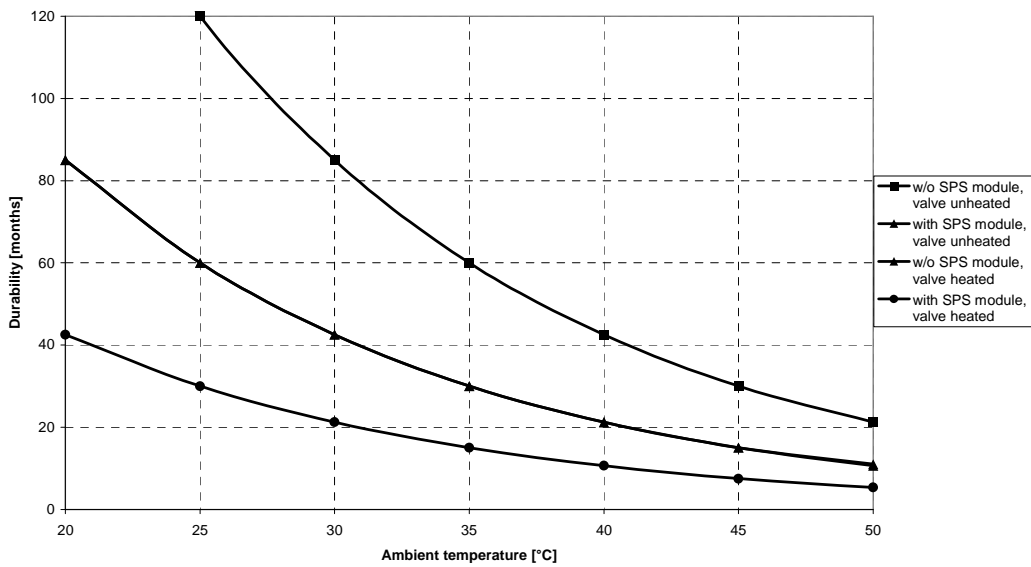

This graph shows estimated life of Ultra Cap PFO for reference and not as guaranteed value.

7.2.3 Retrofit / replacement procedure

Top view on control and actuating unit with panel removed:

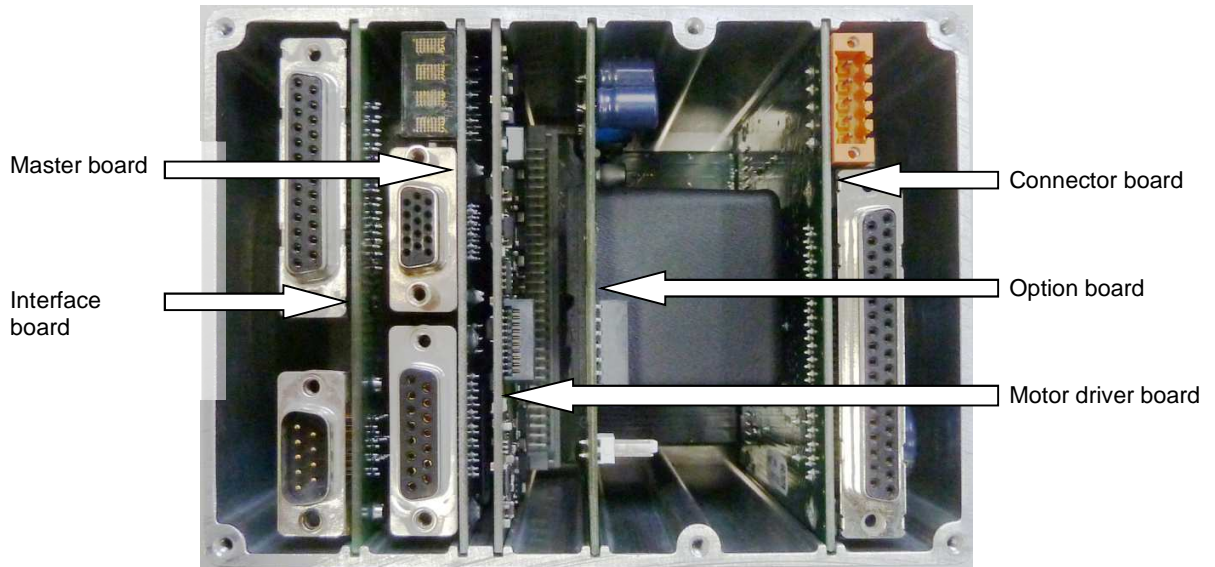

All boards have a fixed position into control and actuating unit. It is not possible to fit a board in other position as shown in picture above!

7.2.3.1 Required tools

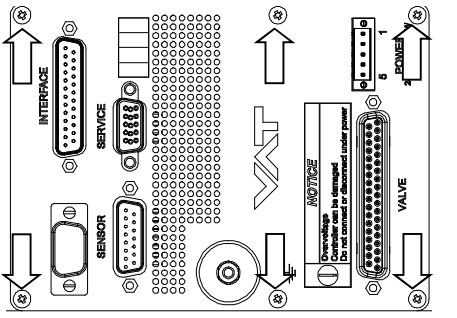

- Open end wrench 4.5 mm
- Pozidriv screw driver size 1
- Open end wrench 7 mm
- Screw driver size 2

Description	Required tools
1. Disconnect all electrical connections at controller.	<p style="text-align: center;">Attention to ESD protection!</p> 
2. Remove the panel screws.	

Description		Required tools
<p>3. Remove this screws and the cover.</p>		<p>Screw driver size 2</p>
<p>4. Remove female screw locks from connectors.</p>		<p>Open end wrench 4.5 mm</p>
<p>5. Lift controller panel carefully.</p>		<p>(sample picture)</p>
<p>6. Remove or replace option board.</p>		<p>(sample picture)</p>

Description		Required tools
7. Reassemble all parts in reverse order (see steps 6...3).		
8. Tighten panel screws with 1.1 Nm (see step 3).		
9. Connect all electrical connections.		Pozidriv screw driver size1 Open end wrench 7 mm



If you need any further information, please contact one of our service centers. You can find the addresses on our website: www.vatvalve.com.



If you need any further information, please contact one of our service centers. You can find the addresses on our website: www.vatvalve.com.

8 Repairs

Repairs may only be carried out by the VAT service staff. In exceptional cases, the customer is allowed to carry out the repairs, but only with the prior consent of VAT.

Please contact one of our service centers. You will find the addresses on our website www.vatvalve.com.

9 Dismounting and Storage

	⚠ WARNING
	Unqualified personnel Inappropriate handling may cause serious injury or property damage. Only qualified personnel are allowed to carry out the described work.

9.1 Dismounting

	NOTICE
	Contamination Gate and other parts of the valve must be protected from contamination. Always wear clean room gloves when handling the valve.

	NOTICE
	Valve in open position Valve body may become damaged if valve gate is in open position. Move valve gate to the closed position before dismantling the valve.

16. Close the valve

17. For dismantling the valve please follow the instructions of chapter: «Installation», however in reverse order.

9.2 Storage

NOTICE	
	<p>Wrong storage</p> <p>Inappropriate temperatures and humidity may cause damage to the product.</p> <p>Valve must be stored at:</p> <ul style="list-style-type: none">– relative humidity between 10% and 70%– temperature between +10 °C and +50 °C– non-condensing environment

NOTICE	
	<p>Inappropriate packaging</p> <p>Product may get damaged if inappropriate packaging material is used.</p> <p>Always use the original packaging material and handle product with care.</p>

1. Clean / decontaminate valve.
2. Cover all valve openings with a protective foil.
3. Pack valve appropriately, by using the original packaging material.

10 Packaging and Transport

	⚠ WARNING
	<p>Unqualified personnel Inappropriate handling may cause serious injury or property damage. Only qualified personnel are allowed to carry out the described work.</p>

	⚠ WARNING
	<p>Harmful substances Risk of injury in case of contact with harmful substances. Remove harmful substances (e. g. toxic, caustic or microbiological ones) from valve before you return the valve to VAT.</p>

	NOTICE
	<p>Inappropriate packaging Product may get damaged if inappropriate packaging material is used. Always use the original packaging material and handle product with care.</p>



- When returning products to VAT, please fill out the VAT form «Declaration of Chemical Contamination of Vacuum Valves and Components» and send it to VAT in advance. The form can be downloaded from our website www.vatvalve.com (Section: Services – Aftersales).
- If products are radioactively contaminated, the VAT form «Contamination and Radiation Report» must be filled out. Please contact VAT in advance.
- If products are sent to VAT in contaminated condition, VAT will carry out the decontaminating procedure at the customer's expense.

10.1 Packaging

	NOTICE
	<p>Valve in open position Valve mechanism may get damaged if valve is in open position. Make sure that the valve is closed.</p>

1. Cover all valve openings with a protective foil.
2. Pack valve appropriately, by using the original packaging material.



VAT disclaims any liability for damages resulting from inappropriate packaging.

10.2 Transport

NOTICE	
	<p>Inappropriate packaging Product may get damaged if inappropriate packaging material is used. Always use the original packaging material and handle product with care.</p>



VAT disclaims any liability for damages resulting from inappropriate packaging.

11 Disposal



WARNING

Unqualified personnel

Inappropriate handling may cause serious injury or property damage.
Only qualified personnel are allowed to carry out the described work.

12 Spare parts



NOTICE

Non-original spare parts

Non-original spare parts may cause damage to the product.
Use original spare parts from VAT only.



- Please specify the fabrication number of the product when you place an order for spare parts; see chapter: «Identification of product». This is to ensure that the appropriate spare parts are supplied.
- VAT makes a difference between spare parts that may be replaced by the customer and those that need to be replaced by the VAT service staff.
- The following table(s) contain spare parts that may be replaced by the customer. If you need any other spare parts, please contact one of our service centers. You will find the addresses on our website www.vatvalve.com.

12.1 Drawing

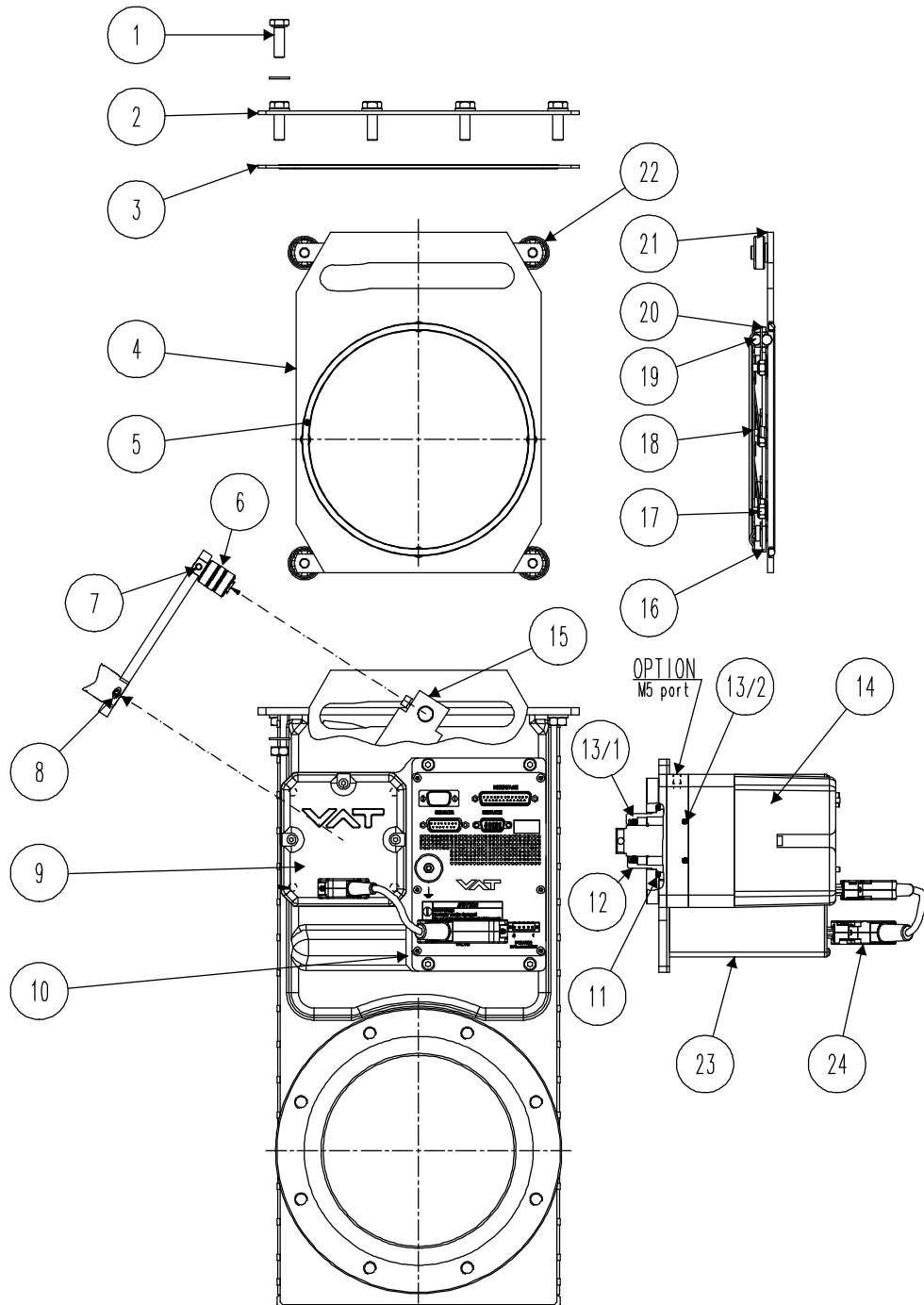

Sample picture



All "Item" refer to chapter «Drawing»

12.1.1 Valve unit with seals and grease

Item	Description	DN 63	DN 80	DN 100	DN 160	DN 200	DN 250	DN 320 DN 350	DN 400
3	Bonnet seal	77775-R1	77775-R1	77778-R1	77781-R1	77784-R1	N-5100-378	N-5100-382	N-5100-383
4	Gate assembly	591063	590996	590858	84275-R1	84608-R1	83481-R1	409173	215561
5	Gate O-ring	N-5102-340	220113	N-5102-351	N-5102-364	N-5100-372	N-5102-453	N-5102-457	N-5100-461
6	Crank bolt	79090-R1	79090-R1	79090-R1	79090-R1	79090-R1	85783-R1	85783-R1	87749-R1
7	Crank bolt mounting screw with spring washer	N-6005-458 N-6162-405	N-6005-458 N-6162-405	N-6005-458 N-6162-405	N-6005-458 N-6162-405	N-6005-458 N-6162-405	N-6005-502 N-6162-407	N-6005-502 N-6162-407	N-6005-502 N-6162-407
8	Feedthrough connection pin	N-6097-478	N-6097-478	N-6097-478	N-6097-480	N-6097-480	N-6097-509	N-6097-509	N-6097-509
14	Actuator: standard with pumping port	546656 489236	546656 489236	546656 489236	478357 487706	478357 487706	711045 539937	711045 539937	707681 587193
11	Static actuator seal	N-5100-222	N-5100-222	N-5100-222	N-5100-225	N-5100-225	N-5100-228	N-5100-228	N-5100-228
21	Locking balls	N-6121-052 (8 pcs)	N-6121-052 (8 pcs)	N-6121-052 (12 pcs)	N-6121-051 (18 pcs)	N-6121-051 (24 pcs)	N-6121-081 (18 pcs)	N-6121-081 (24 pcs)	N-6121-097 (32 pcs)
23	Controller	On request. To many to list.							
22	Ball bearing assembly	66856-R1 (1 pc)	66856-R1 (1 pc)	67064-R1 (2 pcs)	84326-R1 (2 pcs)	80642-R1 (2 pcs)	99205-R1 (4 pcs)	99205-R1 (4 pcs)	77286-01 (4 pcs)
	Seal kit vacuum	97442-R1	225315	97446-R1	85047-R1	95939-R1	98472-R1	98474-R1	98476-R1
	Feedthrough assembling tool		91001-R1				227400		
	VAT vacuum grease (40g)		N-6951-012						

12.1.2 Controller

Item	Description	Part number
	Control and actuating unit	Too many to list. Please contact VAT.
	Option board with SPS module (±15 VDC sensor power supply)	371399
	Option board with PFO module DN63...250 (power failure option)	376419
	Option board with PFO module DN320...400 (power failure option)	875669
	Option board with SPS und PFO module DN63...250 (power failure option)	376098
	Option board with SPS und PFO module DN320...400 (power failure option)	875668

12.1.3 Accessories

Description	Part number
24 VDC power supply unit (input: 100 – 240 VAC)	572699
'Control Performance Analyzer' package for Windows®	free download from: http://www.vatvalve.com/customer-service/informations-and-downloads/control-performance-analyzer
Service cable (PC to valve Service connector)	230327 free wiring information available for download from: http://www.vatvalve.com/customer-service/informations-and-downloads/control-performance-analyzer
Connector kit consisting of: •DB-9 female POWER plug •DB-15 male SENSOR plug •DB-25 male INTERFACE plug	242411
Service Box 2	601BS-29NN-000
Control panel (rack-mount version of Service Box 2)	602BS-29LE-000
O-ring removal tool	234859
VAT valve cleaning tool	305709

12.1.3.1 Centering ring with Viton o-ring

Valve size		DN 63 / 2½"	DN 80 / 3"	DN 100 / 4"
Product ordering number		64236 -	64238 -	64240 -
Centering ring with Viton o-ring (for ISO-F installation only)	Aluminum	32036-QAZV	32038-QAZV	32040-QAZV
	Stainless steel	32036-QEZV	32038-QEZV	32040-QEZV

Valve size		DN 160 / 6"	DN 200 / 8"	DN 250 / 10"
Product ordering number		64244 -	64246 -	64248 -
Centering ring with Viton o-ring (for ISO-F installation only)	Aluminum	32044-QAZV	32046-QAZV	32048-QAZV
	Stainless steel	32044-QEZV	32046-QEZV	32048-QEZV

Valve size		DN 320 / 12"	DN 350 / 14"	DN 400 / 16"
Product ordering number		64250 -	64251 -	64252 -
Centering ring with Viton o-ring (for ISO-F installation only)	Aluminum	32050-QAZV	none	32052-QAZV

13**Appendix**

No information entered on time.

This page left blank intentionally.